

MPlus+

Portable Lateral & Mini-Mainline Push System

OPERATION & MAINTENANCE MANUAL
P/N CH905, Revision: 12.2024

MPlus+ XL Configuration



CHAPTER 1 - Introduction

| | |
|----------------------------------|---|
| MPlus+ System Introduction | 1 |
|----------------------------------|---|

CHAPTER 2 - Equipment Overview

| | |
|--------------------------|---|
| Equipment Overview | 2 |
|--------------------------|---|

CHAPTER 3 - System Setup & Installation

| | |
|--|----|
| Electrical & Physical Connections | 10 |
| Installing the Self Upright Mini Camera and Centering Ball On The MPlus+..... | 12 |
| Installing the Lateral Pan & Tilt Camera on the MPlus+ XL | 14 |
| Installing the Self Upright Mini Camera on the MPlus+ XL..... | 15 |
| Adjusting the Handle Height | 16 |
| Adjusting the Cable Guide | 17 |
| Installing the Debris Bag | 18 |
| Installing the Accessory Bag..... | 19 |
| Installing the Control Unit..... | 20 |
| Installing the Sunshade..... | 22 |
| Connecting the Coiler to the PCU | 23 |
| Configuring the Coiler and Push Cable | 24 |

CHAPTER 4 - Operating the System

| | |
|--|----|
| Operation & Maintenance Instructions | 26 |
| PCU Features | 27 |
| Line Trace | 29 |
| Brake Tension | 29 |
| System Interface | 30 |
| DVR Controls Diagram and Functions | 32 |
| Keypad Functions | 33 |
| Digital Video Recorder Instructions | 35 |
| DPad Controls Diagram and Functions..... | 36 |
| Qwerty Keyboard Instructions | 38 |
| Main System Menu Functions | 40 |
| System Menu | 40 |
| Advanced Configuration | 45 |

CHAPTER 4 - Operating the System... continued

| | |
|--|----|
| Granite Mode | 46 |
| System Status | 56 |
| PT Status | 56 |
| Micro Pan & Tilt Status | 58 |
| Copyright | 60 |
| Preconfigured Text Writing Screens | 61 |
| Other Codes..... | 62 |
| CUES Base Codes | 64 |

CHAPTER 5 - BOMs & Drawings

| | |
|------------------------|----|
| BOMs and Drawings..... | 75 |
|------------------------|----|

APPENDICES

| | |
|--|----|
| Appendix A - List of Status Messages | 84 |
| Appendix B - MPlus+ Field Firmware Updates | 88 |
| Warranty Information | 94 |
| CUES Safety Precautions | 95 |
| CUES Material Return Policy..... | 96 |
| CUES Parts & Service..... | 98 |
| Record of Revisions..... | 99 |



CUES® equipment is designed to be easy to use during day to day operation. However, it is powered electrically and thus must be operated with care and safety. PLEASE READ THE INFORMATION ON SAFETY AND MAINTENANCE EVEN IF THE SYSTEM IS SET UP BY SOMEONE ELSE.

Care was taken in the design of this product and in the production of this document and related materials. However, **CUES**® makes no warranty for the use of its products and assumes no responsibility for any errors or omissions in this document or for incidental or consequential damages resulting from the use of the products or the information contained in this document. Specifications may change without notice.

All rights are reserved. No part of this publication may be reproduced, stored in any information system, or transmitted by any means, manual, electronic, or mechanical without the prior written permission of **CUES**®.

We would be pleased to hear from you. If you see any errors or desirable extensions or improvements, please write us at the following address, C/O Operator's Manuals: **CUES**® Corporate Office 3600 Rio Vista Avenue Orlando, Florida 32805

More locations to serve you!

CUES® Corporate Office
3600 Rio Vista Avenue
Orlando, Florida 32805
800-327-7791
407-425-1569 FAX

8am - 6pm EST M-Fri

CUES® Atlanta
3755 Industrial Ct.
NW, Suite 14
Suwanee, GA 30024
770-945-8674
770-945-9604 FAX

8am - 5pm EST M-Fri

CUES West
1943 S. Augusta Ct.
Ontario, CA 91761
909-923-2001
909-923-2091 FAX

7^{AM} - 6^{PM} PST M-Fri

CUES® Northern California
640 Eubanks Court, Suite C
Vacaville, CA 95688
Phone: 866-358-CUES
Fax: 707-449-0260

8:00^{AM} - 5^{PM} PST M-Fri

CUES® MidWest
2325 Parklawn Drive, Suite K
Waukesha, WI 53186
Phone:: 262-717-3165
Fax: 262-717-3167

7AM - 4PM CST M-Fri

CUES® Canada
1675 Sismet Rd., #2
Mississauga, Ontario
Canada L4W 1P9
905-238-9178
905-238-5018 FAX

8^{AM} - 5^{PM} EST M-Fri

CUES Northwest
1000 NW Commerce Ct., Suite B
Estacada, OR 97023
Phone: 1.800.432.1549 ext: 403
Fax: 909-923-2051

CUES® toll free hot line for
Customer Service and ordering parts:
800-854-CUES (800-854-2837)

Copyright © 2013 by **CUES**®

All rights reserved. No part of this publication covered by the copyright hereon may be reproduced or used in any form by any means - graphic, electronic, or mechanical, including photocopying, recording, taping, or information storage and retrieval systems - without the expressed written permission of **CUES**®. Violators will be prosecuted.

Styles and specifications are subject to change without notice.

First version published in 2004. Printed in the United States of America.

MPLUS+ SYSTEM - INTRODUCTION

This manual includes setup, operation, troubleshooting, and maintenance instructions for the CUES MPlus+ Portable Lateral & Mini-Mainline Push System. Equipment information is included in the Equipment Overview chapter in this manual. The instructions in this manual are for the MPlus+ system and its components only.

The MPlus+ System is designed to inspect service laterals and/or pipelines 2” through 12” in diameter. The system operates as a stand-alone system, but is also fully compatible with external observation software or other asset management systems. An optional mainline interface is available for operation with standard CUES TV trucks. The MPlus+ can be powered from the built-in, rechargeable battery, 110 AC mains power, or 12 VDC power. If uncertain about your specific system or need more information regarding the MPlus+, please call our Customer Service Department at 1-800-327-7791.

The CUES MPlus+ is designed to:

- Operate as an All-In-One system or the modular design allows the control unit to be removed and used separately or to accommodate compact storage.
- Operate with a standard TV inspection system (optional).
- Multiple camera heads are available including self-leveling for 2” through 12” pipelines and an advanced Pan & Tilt camera head for 4” through 12 pipelines.
- The standard configuration reel will operate/store up to 350’ of fiberglass rod push cable (optional) optimized for lateral applications.
- The optional large configuration XL reel will operate/store up to 500’ of fiberglass rod push cable optimized for mainline and large pipe applications.
- A third reel, the CUES IGGY reel with up to 500 feet of cable, is also available.
- Operate in extreme conditions with the heavy duty construction and weather / water resistant, injection-molded control unit.

STANDARD MPLUS+ SHOWN



2 EQUIPMENT OVERVIEW

STANDARD MPLUS+ SYSTEM



STANDARD MPLUS+ SYSTEM

The standard MPlus+ System consists of the following equipment. Refer to the BOM and Exploded View Drawings at the back of this manual for additional information.

1 (CH377) Control Unit with Text Writing, Observation Coding, Digital Recording and Industrial Grade Monitor in an Injection Molded Enclosure:

The MPlus+ system is controlled by the PCU (power control unit). The PCU contains all of the controls for the system including system power, camera, lighting, recording, video titling, and observation coding. The following functions are included:

- 8.4" industrial grade, optically bonded, sunlight viewable, monitor with anti-reflective properties and LED backlighting
- Operator Interface with controls for all camera functions
- Video Titling includes multiple predefined and customizable screens
- Digital video recording features recording and playback of video and screenshot picture images; Includes an internal USB flash drive with 128 GB storage and an external USB flash drive with 16 GB storage for copying videos and photos
- Control Unit quick bracket mount for attaching to the coiler with hands free locking
- System Interface connector features Video, Audio, distance counter quadrature and 12VDC outputs and a Video input
- Built-in Li-Ion Battery with advanced charging technology for 4+ hours of continuous use
- Universal AC power input 85-264 volt AC, 50/60 Hz, or 12 volt DC power source
- Operation & Maintenance User Manual

2 (CH300) Stainless Steel Coiler:

The coiler assembly stores up to 350 feet of .197" fiberglass push rod and is equipped with 10" wheels for easy portability.

- Heavy 18 gauge and corrosion-resistant Stainless Steel construction
- Adjustable height handle for portability with cam locks and button stops; adjustable from 35" to 47"
- Large 10" durable wheels for portability and a balanced footprint for stability
- Quick-Connect allows Control Unit mounting with 3 axes adjustability
- Adjustable coiler brake
- Integral distance sensor

3 (CH347-20PE) 200' of .197" Diameter Fiberglass Rod and HDPE Jacket Push Cable:

The push cable transmits power to the self-leveling color camera and integral light ring, and also carries the video signal back to the PCU for display on the monitor.

- Push Cable with durable HDPE jacket and advanced fiberglass rod

4 (SR320 SERIES) Self-Leveling Color Camera:

The mini-camera provides live video during sewer pipe inspections. It attaches to the push cable by utilizing a flexible leader spring with CX-1 connector.

- 1 ½" diameter Stainless Steel camera head designed for 2" to 12" pipelines
- 512 Hz integral sonde
- 12 high intensity LED's

2 EQUIPMENT OVERVIEW

MPLUS+ STANDARD SYSTEM - CONTINUED

5 (CH900) - ACCESSORY KIT:

The standard configuration accessory kit includes all necessary components for full operation.

- Sunshield for enhanced sunlight viewability (CH083)
- 10ft interconnect cable for connecting the coiler to the control unit (CH070)
- AC power cord for 85-264 volt AC, 50/60 Hz, operation (165006)
- Camera head protection sleeve (LM299)

SYSTEM WEIGHTS - STANDARD MPLUS+ CONFIGURATION

CH300, COILER WEIGHT MINUS PUSH CABLE = 31 LBS.

CH377, CONTROL UNIT CASE WEIGHT = 14 LBS.

CH347 - xx, 100 FOOT PUSH CABLE WEIGHT = 8.5 LBS.

SR320 SERIES, SELF-UPRIGHT CAMERA = .55 LBS

CH900, ACCESSORY KIT = 1 LBS (not shown)

INCLUDED ACCESSORIES



OPTIONAL EQUIPMENT

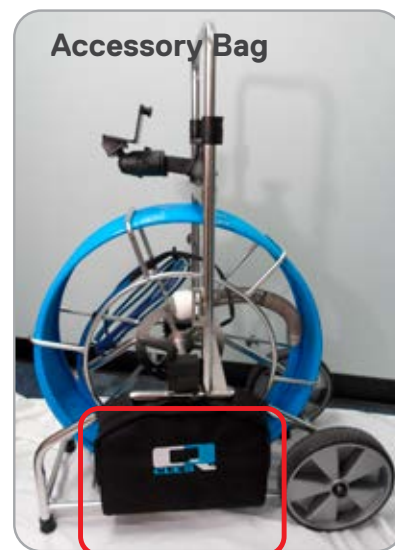
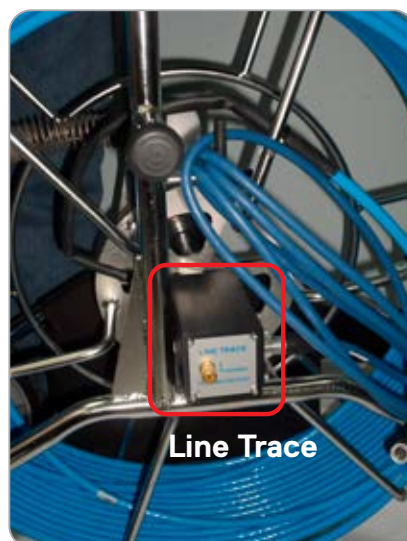

MPLUS+ STANDARD SYSTEM - OPTIONAL EQUIPMENT

The MPlus+ System offers a variety of optional equipment to expand the role of the push system.

| DESCRIPTION | PART NUMBER |
|--|-----------------------|
| Accessory bag for storage, attaches to coiler frame | CH061 |
| Debris Bag for push cable coiler basket | CH062 |
| LOCATOR,512HZ,8KHZ,33KHZSONDE+LINE | MS610 |
| LINE TRACE TRANSMITTER,5WATT | MS620 |
| Line-Trace Post Terminal for Line Locating | CH901 |
| 100 ft. push cable | CH347-10PE |
| 150 ft. push cable | CH347-15PE |
| 250 ft. push cable | CH347-25PE |
| 300 ft. push cable | CH347-30PE |
| 350 ft. push cable | CH347-35PE |
| MPlus+ Control Unit with digital wireless video transmission kit | CH377-1 |
| Truck Digital 2.4 GHz Wireless Video Receiver kit to work with wireless MPlus+ (CH377-1) option | TR1955 |
| Add Mini Pan and Tilt Camera with automatic self leveling, 360 degrees pan and rotate, built in selectable 512 Hz and 8 kHz sonde, built in lens wiper | Call for availability |
| Add the Above Mini Pan and Tilt Camera in lieu of the fixed view Camera | Call for availability |
| Cable to operate MP+PLUS with Multi Conductor Truck system | CH352 |
| Granite-Net Translator with video and footage counter interface | CH309 |
| Granite Net Basic Decision Support Software | GN502 |
| Granite Net Advanced Decision Support Software | GN501 |

2 EQUIPMENT OVERVIEW

MPLUS+ XL LARGE CONFIGURATION SYSTEM



MPLUS+ XL LARGE CONFIGURATION SYSTEM

The MPlus+ XL System consists of the following equipment. Refer to the BOM and Exploded View Drawings at the back of this manual for additional information.

1 (CH377) Control Unit with Text Writing, Observation Coding, Digital Recording and Industrial Grade Monitor in an Injection Molded Enclosure:

- The MPlus+ XL system is controlled by the PCU (power control unit). The PCU contains all of the controls for the system including system power, camera, P/T camera, lighting, recording, video titling, and observation coding. The CH377 Control Unit is compatible with the standard and XL configurations. The following functions are included:
- 8.4" industrial grade, optically bonded, sunlight viewable, monitor with anti-reflective properties and LED backlighting
- Operator Interface with controls for all camera functions including:
 - Pan right and pan left
 - Rotate clockwise and rotate counter-clockwise
 - Focus near (-) and focus far (+)
 - Home, Automatic picture leveling
- Video Titling includes multiple predefined and customizable screens
- Digital video recording features recording and playback of video and screenshot picture images; Includes an internal USB flash drive with 128 GB storage and an external USB flash drive with 16 GB storage for copying videos and photos
- Control Unit quick bracket mount for attaching to the coiler with hands free locking
- System Interface connector features Video, Audio, distance counter quadrature and 12VDC outputs and a Video input
- Built-in Li-Ion Battery with advanced charging technology for 4+ hours of continuous use
- Universal AC power input 85-264 volt AC, 50/60 Hz, or 12 volt DC power source
- Operation & Maintenance User Manual

2 (CH301) Stainless Steel Coiler:

- The coiler assembly stores up to 500 feet of .236" fiberglass push rod and is equipped with 10" wheels for easy portability.
- Heavy 18 gauge and corrosion-resistant Stainless Steel construction
- Large 10" durable wheels for portability and a balanced footprint for stability
- Quick-Connect allows Control Unit mounting with 3 axes adjustability
- Adjustable coiler brake
- Integral distance sensor

3 (CH346-20PE) 200' of .517" Push Cable (.236" fiberglass rod) and HDPE Jacket Push Cable:

- The push cable transmits power to the self-leveling color camera or PT camera head and also carries the video signal back to the PCU.
- Push Cable with durable HDPE jacket and advanced fiberglass rod
- Features a disconnect termination for Camera Head interchangeability

4 (SR320 SERIES) Self-Leveling Color Camera:

- The mini-camera provides live video during sewer pipe inspections. It attaches to the push cable by utilizing a flexible leader spring (CH342) with a disconnect termination.
- 1 ½" diameter Stainless Steel camera head designed for 2" to 12" pipelines
- 512 Hz integral sonde
- 12 high intensity LED's

5 (CH366 KIT - CONTAINS LL300 SERIES) P/T Camera:

- The Pan and Tilt camera provides live video during sewer pipe inspections. It attaches to the push cable by utilizing a flexible leader spring (CH341) with a disconnect termination.
- 2 ½" diameter Stainless Steel and anodized aluminum alloy camera head designed for 4" to 12" pipelines
- Variable focus, fixed iris and auto speed shutter
- Lens wiper
- 1/3" Interline Transfer CCD with a pixel resolution of 768(H) x 494(V)
- 512 Hz and 8kHz integral sonde
- 6 Spot and 6 Flood LED's

2 EQUIPMENT OVERVIEW

MPLUS+ XL LARGE CONFIGURATION SYSTEM - CONTINUED

- 6** (CH900) - ACCESSORY KIT:
- The standard configuration accessory kit includes all necessary components for full operation.
 - Sunshield for enhanced sunlight viewability (CH083)
 - 10ft interconnect cable for connecting the coiler to the control unit (CH070)
 - AC power cord for 85-264 volt AC, 50/60 Hz, operation (165006)
 - Camera head protection sleeve (LM299) for SR320 configured systems
 - Large pipe skid for 6-12" pipe operation (CH906) for LL300 P/T configured systems (optional for SR320 configurations)

SYSTEM WEIGHTS - LARGE MPLUS+ CONFIGURATION

CH301, COILER WEIGHT MINUS PUSH CABLE = 39 LBS.

CH377, CONTROL UNIT CASE WEIGHT = 14 LBS.

CH346-xx, 100 ft PUSH CABLE WEIGHT = 14.4 LBS. / per 100 ft

SR320 SERIES, SELF-UPRIGHT CAMERA = .55 LBS.

CH342, SPRING END ASSY FOR SR320 = 1.25 LBS.

LL300, P/T CAMERA ASSY = 1.85 LBS.

CH341, SPRING END ASSY FOR LL300 = 1.25 LBS.

CH900, ACCESSORY KIT = 1 LB.

INCLUDED ACCESSORIES



OPTIONAL EQUIPMENT

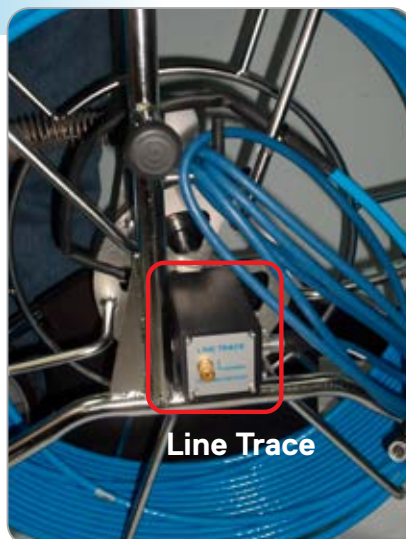

MPLUS XL LARGE CONFIGURATION - OPTIONAL EQUIPMENT

| DESCRIPTION | PART NUMBER |
|---|-------------|
| Accessory bag for storage, attaches to coiler frame | CH061 |
| Large pipe skid for 6-12" pipe operation for SR320 and LL300 configurations | CH906 |
| Prototek Digital Receiver, 512 Hz / 16 Hz / 8 kHz / 16 kHz / 33 kHz / 65 kHz | MS610 |
| Prototek Analog Receiver, 512 Hz | MS319 |
| Line-Trace Post Terminal for Line Locating | CH901 |
| 100 ft. push cable | CH346-10PE |
| 150 ft. push cable | CH346-20PE |
| 250 ft. push cable | CH346-25PE |
| 300 ft. push cable | CH346-30PE |
| 350 ft. push cable | CH346-35PE |
| 400 ft push cable | CH346-40PE |
| 500 ft push cable | CH346-50PE |
| MPlus+ Control Unit with digital wireless video transmission kit | CH377-1 |
| Truck Digital 2.4 GHz Wireless Video Receiver kit to work with wireless MPlus+ (CH377-1) option | TR1955 |
| Cable to operate MP+PLUS with Multi Conductor Truck system | CH352 |
| Cable with RCA Video Output – 12ft | CH329 |
| Cable – 12 pin to 5 pin | CH343 |
| Granite-Net Translator with video and footage counter interface | CH309 |
| Granite Net Basic Decision Support Software | GN902 |
| Granite Net Advanced Decision Support Software | GN901 |

3

SET-UP & INSTALLATION

ELECTRICAL & PHYSICAL CONNECTIONS - STANDARD AND “XL” SYSTEMS

To reduce the risk of equipment damage, please read the following instructions prior to operating the system. Ensure that all of the equipment is turned to the OFF (O) position prior to connecting the MPlus+ system. Inspect all of the cables and connectors for cuts or worn areas prior to operating the equipment. Repair or replace worn cables immediately.

PROCEDURE: Connecting the System

Power Source:

The MPlus+ can be powered from the built-in, rechargeable battery, 110 AC mains power, or 12 VDC power. If the internal battery is not going to be utilized, connect the unit to one of the external power sources listed above.

Camera Centering Ball (Standard System Only):

Ensure the centering ball, if needed, is attached to the mini camera as shown in this chapter.

Mini-Camera (Standard or “XL” System):

Ensure the mini-camera is connected and secured to the CX-1 cable end as shown in this chapter.

Adjustable Handle Height (Standard System Only):

The MPlus+ includes a height-adjustable handle for portability with cam locks and button stops. Refer to the handle height adjustment instructions in this chapter.

Debris Bag (Standard System Only):

An optional debris bag is provided to prevent debris from spilling/leaking out during and after the inspection. Ensure the debris bag is attached to the MPlus+ per the instructions in this chapter.

Adjustable Cable Guide: Ensure the push cable is inserted through the cable guide for the most efficient operation.

Accessory Bag (Standard or “XL” System):

An optional accessory bag is available to store additional items, as needed. Ensure the accessory bag is attached to the MPlus+ per the instructions in this chapter.

Monitor (Standard or “XL” System):

Ensure that the Control Unit cable is connected as shown in this chapter.

Power Control Unit (PCU), (Standard or “XL” System):

The MPlus+ system is controlled by the PCU (power control unit). The PCU contains all of the controls for the system including system power, camera, lighting, recording, video titling, and observation coding. Ensure that the PCU is connected as shown.

To adjust the Control Unit position, perform the following (Standard or “XL” System):

Swivel/rotate the PCU vertically and left-to-right to place the unit in differing viewing angles. Once the desired position is determined, secure the unit by turning the hand knobs.

Mini Pan & Tilt Camera (“XL” System Only):

The Mini Pan and Tilt camera provides live video during sewer pipe inspections. It attaches to the push cable by utilizing a flexible leader spring (CH341) with a disconnect termination.

Large Pipe Skids:

The large pipe skid is available for all MPlus+ systems and allows operation in 6” to 12” pipelines. Two (2) wheeled runners are provided for adjustability. The smaller wheeled runner is designed for 6” and 8” pipelines. The larger wheeled runner is designed for 10” and 12” pipelines.

3 SET-UP & INSTALLATION

INSTALLING THE SELF UPRIGHT MINI CAMERA AND CENTERING BALL - STANDARD MPLUS+ ONLY

Centering Ball, (2) Pieces, P/N LM299

Self Upright Camera P/N SR320

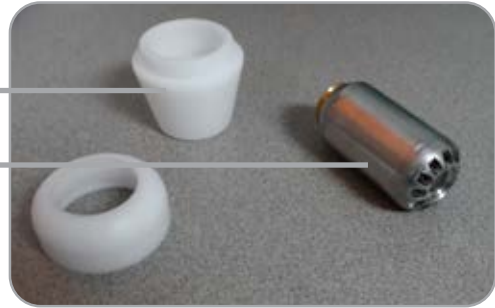

To install the self upright camera and centering ball on the MPlus+, perform the following:

Remove the orange cap that is covering the end of the CX-1 connector as shown.



INSTALLING THE SELF UPRIGHT MINI CAMERA AND CENTERING BALL - STANDARD MPLUS+, CONTINUED

Slide the bottom piece of the centering ball onto the end of the CX-1 connector as shown.



Secure the mini camera to the end of the CX-1 connector as shown.



Place the top piece of the centering ball onto the camera as shown.



Twist the top and bottom pieces of the centering ball together until secure.



3 SET-UP & INSTALLATION

INSTALLING A PAN & TILT CAMERA - MPLUS+ XL SYSTEM ONLY



NOTE: If the electrical contacts on the camera (PAL P/N LL300-2, NTSC P/N LL300-3) or spring assembly (CH341) are dirty, clean them with alcohol, let dry, and apply a small amount of DeoxIT (CS569). If the O-ring on the camera is dry, apply a thin film of O-ring lube (CS390) to the O-ring.

- 1** Align the pin on the camera to the mating hole on the spring assembly and insert the camera into the spring assembly. Using a stubby 3/32" Allen Wrench (HW2908), route the (6) supplied screws (103089) through the (6) holes located at the end of the spring assembly and tighten until securely seated on the camera.

NOTE: If the electrical contacts on the push cable (CH346-__PE) or spring assembly (CH341) are dirty, clean them with alcohol, let dry, and apply a small amount of DeoxIT (CS569). If the O-ring on the push cable connector is dry, apply a thin film of O-ring lube (CS390) to the O-ring.

- 2** Align the pin on the push cable with the mating hole on the spring assembly and insert the push cable into the spring assembly. Turn the knurled locknut on the spring assembly until the spring assembly is securely seated on the push cable.

INSTALLING THE SELF-UPRIGHT CAMERA - MPLUS+ XL SYSTEM ONLY



NOTE: If the electrical contacts on the camera (SR320 SERIES) or spring assembly (CH342) are dirty, clean them with alcohol, let dry, and apply a small amount of DeoxIT (CS569). If the O-ring on the camera is dry, apply a thin film of O-ring lube (CS390) to the O-ring.

1 Screw the camera into the spring assembly until it is securely seated.

NOTE: If the electrical contacts on the push cable (CH346-__PE) or spring assembly (CH342) are dirty, clean them with alcohol, let dry, and apply a small amount of DeoxIT (CS569). If the O-ring on the push cable connector is dry, apply a thin film of O-ring lube (CS390) to the O-ring.

2 Align the pin on the push cable with the mating hole on the spring assembly and insert the push cable into the spring assembly. Turn the knurled locknut on the spring assembly until the spring assembly is securely seated on the push cable.

3 SET-UP & INSTALLATION

ADJUSTING THE HANDLE HEIGHT - STANDARD MPLUS+ ONLY

The MPlus+ includes a height-adjustable handle for portability with cam locks and button stops.

To adjust the height of the handle, open the cam locks on each side of the handle.

Extend/retract the handle to the desired position.

To secure, engage the cam locks on both sides of the handle as shown.



ADJUSTING THE CABLE GUIDE - STANDARD OR XL VERSION

An adjustable cable guide is provided to guide the cable while being released / retrieved from the coiler.

The cable guide is set at the factory, but can be adjusted based on your specific needs.

To adjust the cable guide, loosen the bolt located on the coiler, then adjust the cable guide height up/down. Secure the bolt to hold into place.

Replacement cable guides, P/N CH006, are available, if needed.

Cable Guide, P/N CH006

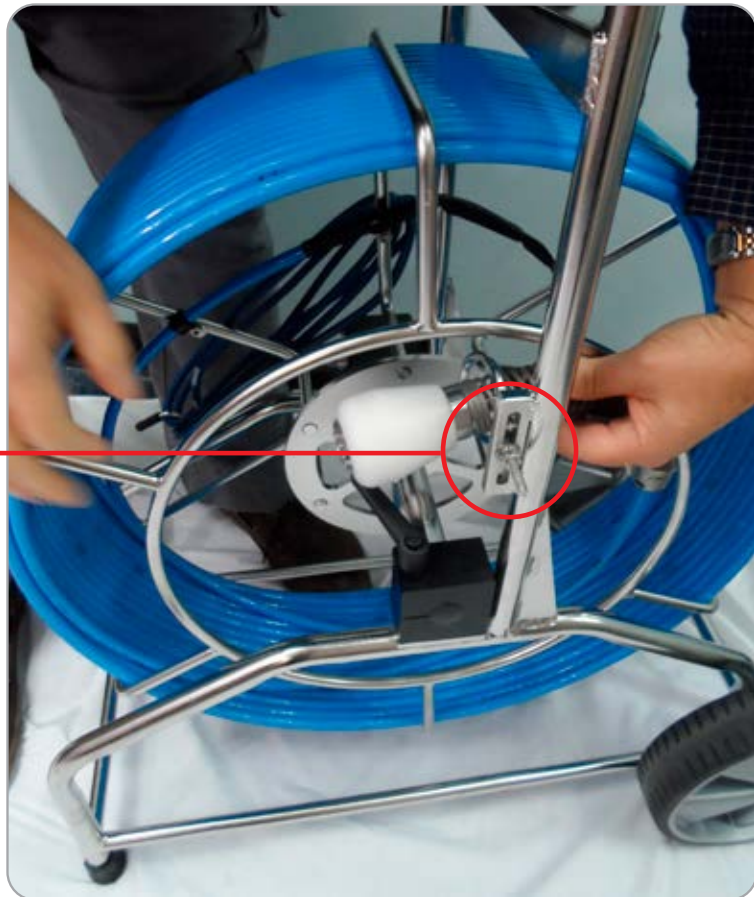

3 SET-UP & INSTALLATION

INSTALLING THE DEBRIS BAG - STANDARD MPLUS+ ONLY

An optional debris bag is provided to prevent debris from spilling/leaking out during and after the inspection.

To attach the debris bag, perform the following:

Wrap the bag around the coiler / cable as shown below.

Continue wrapping around the coiler and then loop it through the bottom of the unit.

Attach the velcro ends together to secure in place.



INSTALLING THE ACCESSORY BAG - STANDARD OR XL VERSION

An accessory bag is provided to store additional items, if needed. It also includes a convenient carry handle for portability.

To attach/remove the bag, secure the (3) velcro flaps onto the cable reel as shown and per below:

Secure the long flap at the bottom of the bag around the bottom of the coiler as shown.

Then wrap the (2) smaller flaps around the coiler.

Press together to ensure good adhesion.

(3) velcro flaps located on the accessory bag

For the XL version only: Route the right velcro strap through the slot in the coiler and secure.

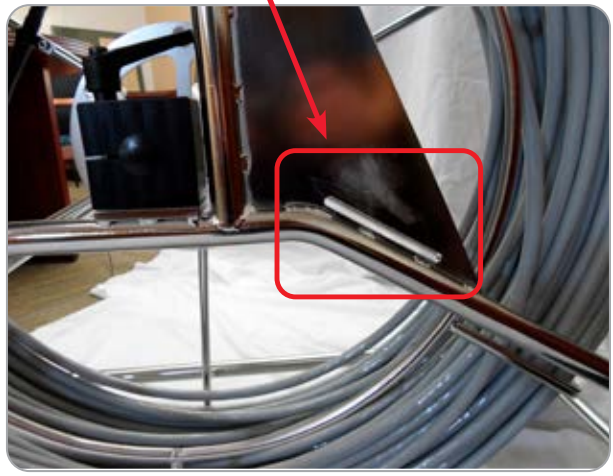

3 SET-UP & INSTALLATION

INSTALLING THE CONTROL UNIT - STANDARD OR XL VERSION

The control unit can be quickly installed/removed for off road/remote jobsites or to accommodate compact storage. The Control Unit features a quick connect mount for attaching to the coiler. The quick-connect “click-lock” feature is a no-hand locking mechanism for simple and secure mounting.

To install the control unit, slide it onto the mounting bracket as shown. Once installed, the bracket will make a clicking sound, which means the unit is locked in place.



To remove/release the control unit, pull the locking pin while simultaneously lifting up on the control unit.



INSTALLING THE CONTROL UNIT - STANDARD OR XL VERSION, CONTINUED

Once installed, the control unit can swivel vertically approximately 90 degrees, and rotate left-to-right approximately 180 degrees for different viewing angles.

To change the angle of the control unit, release the hand knob located on the ball mount. Swivel/rotate the unit vertically and left-to-right to place the unit in differing viewing angles. Once the desired position is determined, secure the unit by turning the hand knobs.

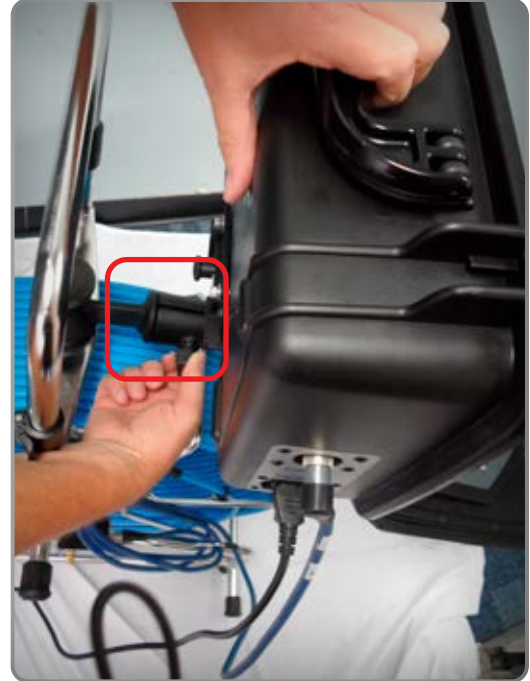

3 SET-UP & INSTALLATION

INSTALLING THE SUNSHADE - STANDARD OR XL VERSION

A removable sunshade is provided for optimum visibility in extreme sunlight conditions.

To install the sunshade, ensure the magnetic flap is attached at the top of the LCD screen and place the sunshade on the control unit as shown.



CONNECTING THE COILER TO THE PCU - STANDARD OR XL VERSION

The coiler and AC connections are located on the side of the control unit.

Attach the interconnect cable, P/N CH070, from the coiler to the control unit as shown.



Connect the AC power cord to the control unit as shown.

Confirm the Battery “Charging” Yellow Light or “Charged” Green Light indication appears on control unit.

3

SET-UP & INSTALLATION

CONFIGURING THE COILER AND PUSH CABLE

Note: The following configuration procedure must be followed after all system related service, push cable service and/or retermination, push cable replacement or if coiler is being interchanged

Enter “Coiler Setup” in the System Menu and confirm or configure PUSH ROD LENGTH, COILER TYPE and COUNT DIRECTION.

COILER SETUP

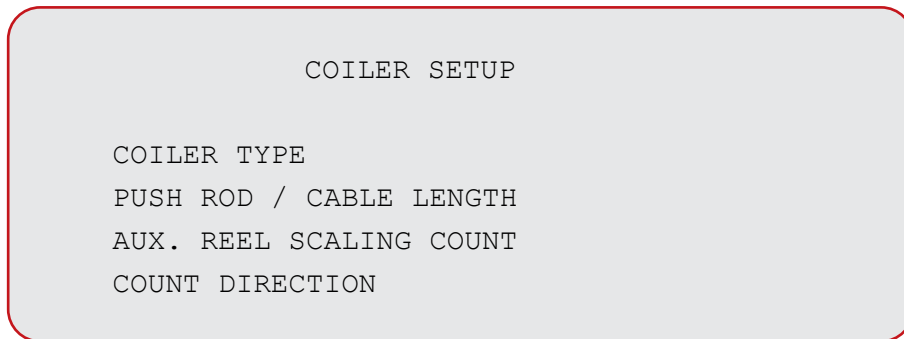

- PUSH ROD / CABLE LENGTH
 - XXX.X - NOTE: enter actual length to one decimal place using the Up Arrow and Down Arrow keys to modify the value in the field displayed. Use the Left Arrow and Right Arrow keys to move within the field. The value is changed upon exiting from the field by pressing <ENTER> or <ESC>.
 - Prior to changing the push rod or cable’s length, all of the cable must be inside the basket/coiler because the firmware assumes this is the case when computing the footage distance.

COILER TYPE

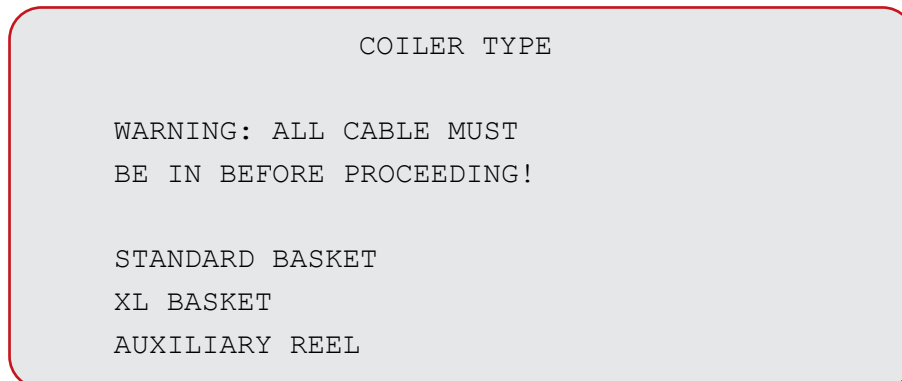

COILER TYPE - continued

- The selection of 'XL' as the Coiler Type automatically selects large cable, internally.
- The combinations of large coiler with standard cable and standard coiler with large cable are invalid and are currently not selectable.
- Changing the coiler type requires an internal reset of the distance calculation firmware, which requires that all of the cable be retracted into the coiler for the distance to count properly.

AUX REEL SCALING COUNT

```
          AUX.  REEL SCALING COUNT
004000 counts per 100 ft

----- DEFAULT VALUES -----
                IGGY : 004000
```

When using an auxiliary reel, the scaling counts must be input in order for the distance to count properly.

- AUX REEL SCALING COUNT
 - XXXXXX – NOTE: enter actual scaling count using the Up Arrow and Down Arrow keys to modify the value in the field displayed. Use the Left Arrow and Right Arrow keys to move within the field. The value is changed upon exiting from the field by pressing <ENTER> or <ESC>.

COUNT DIRECTION

```
          COUNT DIRECTION

UP
DOWN
```

Count direction refers to whether the footage counts up or down when the cable is pulled out.

4

OPERATING THE SYSTEM

OPERATION & MAINTENANCE INSTRUCTIONS

To reduce the risk of equipment damage, please read the following instructions prior to operating the system. ***Ensure that all of the equipment is connected per the instructions included in the previous SETUP & INSTALLATION CHAPTER.***

PROCEDURE: Operating the System

The MPlus+ system is controlled by the PCU (power control unit). The PCU contains all of the controls for the system including system power, camera, lighting, recording, video titling, and observation coding. Ensure that the AC power cord or optional DC power cord is connected to the Control Unit. An internal Li-Ion rechargeable battery can also be used.

If a power cord is used, verify that the battery “Charging” Yellow Light or “Charged” Green Light indication illuminates on the PCU.

1. Ensure that all of the equipment is connected as described in the SET-UP & INSTALLATION chapter.
2. Prior to turning on the system, ensure that all of the cable is inside of the basket/coiler because the firmware assumes this is the case when displaying the footage distance.
3. On the Power Control Unit (PCU), press the ON/OFF power button to cycle the system ON.
 - Ensure that the system power LED is illuminated blue.
 - Verify that the LCD display powers up and displays a video image.
 - 20 seconds after powering on the system, verify that the DVR is operational by pressing the [MENU/OK] button in the center of the oval. Once the menu appears, press the [STOP/BACK] button to remove the menu from the screen.
4. Ensure that a clear picture is evident on the screen prior to placing the camera in the pipeline.
5. Place the mini camera into the pipe to be inspected.
6. Refer to the additional SYSTEM OPERATION – SYSTEM INTERFACE section for additional functionality including Video/Audio Recording, Text Writing, Observation Coding, etc.
7. It is recommended to start with a standard inspection in LIVE MODE.
8. Perform push inspection operations.

STANDARD OR XL VERSION, AUXILLIARY CONNECTIONS



The PCU has been updated to reflect significant improvements, including the addition of Pan & Tilt Camera Head functionality. The operator interface includes Pan, Tilt, Focus, Home, and automatic picture-

Monitor:

A high-resolution, high-visibility LCD Monitor is provided to view the inspection / observations.

Power Control Unit (PCU):

The MPlus+ XL system is controlled by the PCU (power control unit). The PCU contains all of the controls for the system including system power, camera, lighting, recording, video titling, and observation coding.

4 OPERATING THE SYSTEM

STANDARD OR XL VERSION, AUXILIARY CONNECTIONS - CONTINUED



MPLUS+ auxiliary connections include auxiliary microphone jack and a multipurpose I/O port that features Video out, Video in, Audio Out, distance counter quadrature out and auxiliary 12vdc out. The following are interconnecting options available for your MPlus+ system. Please contact CUES for a recommended or full list of available options.

Auxilliary Microphone Jack

Multipurpose I/O Port

- CH352 – Cable to operate MPlus+ with Multi Conductor Truck System – Connects Video from MPlus+ to 12 pin Mainline Cable
- CH343 – 12pin to 5 pin Cable – Converts 12 pin CH352 Cable to 5 pin output.
- CH329 - Cable with RCA Video Output – 12ft
- CH309 - Granite-Net Translator with video and footage counter interface

STANDARD OR XL VERSION, AUXILLIARY CONNECTIONS - CONTINUED



LINE TRACE (STANDARD OR XL VERSION)

An optional line trace is available to provide a connection point for a line transmitter. It is compatible with multiple frequencies, including 128 Hz, 1 kHz, 8 Hz, and 33 kHz. Maximum 10 watts. Please contact CUES for recommended transmitter options.



BRAKE TENSION (STANDARD OR XL VERSION)

A brake tension adjustment handle is provided to freely rotate the basket. Adjust the handle to apply more/less tension while the cable is being released /retrieved, based on your preferences. Complete clockwise rotation will lock the basket in place.

SYSTEM INTERFACE

MPLUS+ FUNCTIONS:

ON/OFF SWITCH - ILLUMINATED

- BLUE LED indicator operates when system is ON.

BATTERY CHARGE STATUS LED INDICATORS

- YELLOW indicates the battery is charging.
- GREEN indicates the battery is fully charged.
- RED indicates battery charging fault. If this occurs, reset the power and verify. If RED is still displayed after resetting, contact CUES for service.
- RED/YELLOW/GREEN LED indicators will be displayed while the system is being charged, even if the system is OFF.

LOW BATTERY INDICATORS

- The display of the battery gauge is selectable from the system menu.
- A low battery indicator will be displayed on the monitor at 10% remaining power, even if battery gauge OFF is selected in the system menu.
- A low battery indicator will flash on the monitor at 5% remaining power.
- The LCD display will power down at 0% remaining power.

Note that the battery gauge is always displayed at startup for a few seconds, regardless of the state of the battery gauge ON/OFF setting.

SYSTEM FAULTS

If the system encounters a problem, or the operator makes a selection which changes one of the settings, a message is displayed for a short amount of time (usually only a few seconds) on the 3rd line from the bottom of the display. The system is completely active during display of these messages.

A list of the messages currently available is provided in Appendix A.

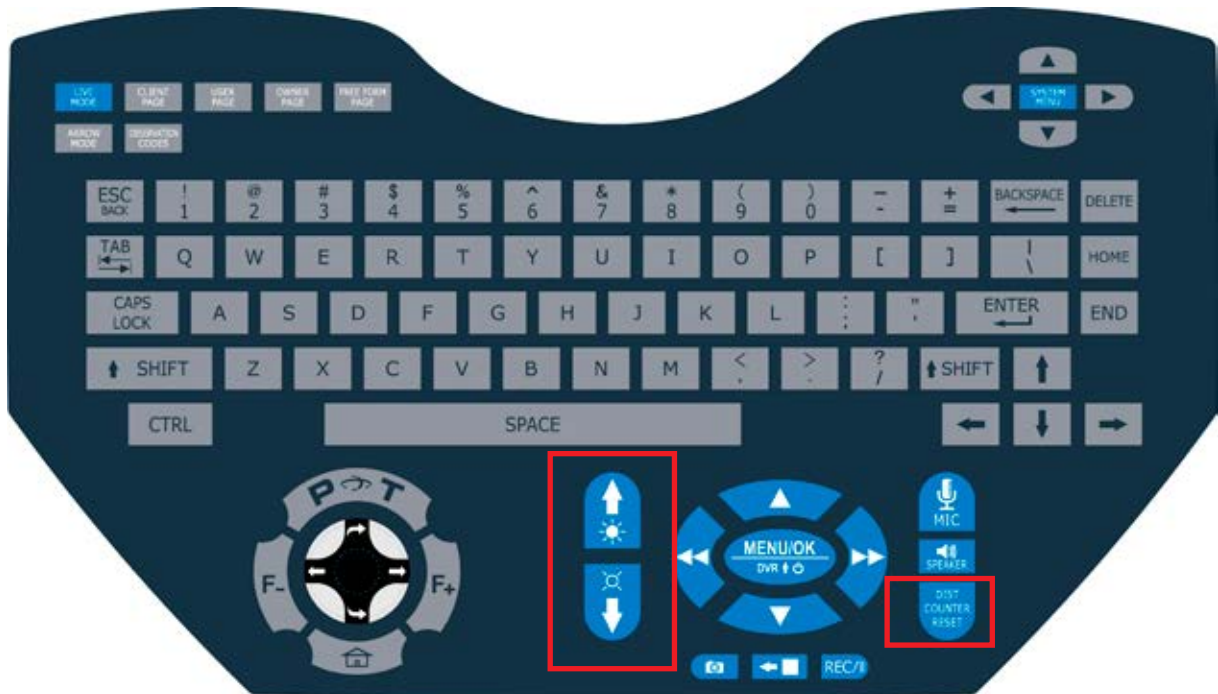

MPLUS+ BASIC SYSTEM FUNCTIONS

CAMERA HEAD LED CONTROL

- LED UP Brightness BUTTON
 - Press to increase the LED brightness from low to high in 19 steps.
- LED DOWN Brightness BUTTON
 - Press to decrease the LED brightness from high to low in 19 steps.

DISTANCE COUNTER RESET

- Press twice quickly to reset the distance counter to zero. After pressing once, a message is displayed indicating that a second press is required for the reset to take place

4 OPERATING THE SYSTEM

DIGITAL VIDEO RECORDER (DVR) CONTROLS DIAGRAM



UP ARROW - DVR NAVIGATION

LEFT ARROW - DVR NAVIGATION ; FAST REWIND

SHIFT - MENU - TOGGLE DVR ON AND BYPASS

DVR MENU SELECT

PHOTO RECORD

STOP RECORDING; BACK OUT OF DVR MENU

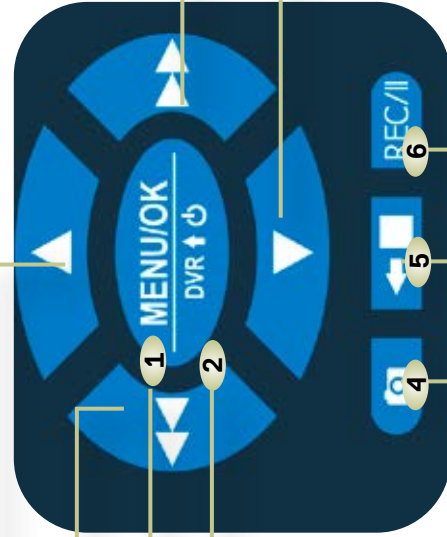

RIGHT ARROW - DVR NAVIGATION
FAST FORWARD

DOWN ARROW - DVR NAVIGATION

START/PAUSE RECORDING

KEYPAD FUNCTIONS (RECORDER)

The DVR Recorder enables recording of live video and individual snapshots from live video. DVR Menu accesses DVR set-up screens and pre-recorded videos.

1. SHIFT - MENU

SHIFT - MENU switches the source of video output to the monitor between the raw video coming into the recorder and the video being output by the DVR module. It can be used to bypass the DVR so its status icons don't appear on the viewing screen or if the input/output processing of the video causes undesirable effects during camera motion. Using these controls to select the source of the video currently being displayed does not affect what is being recorded.

2. MENU / OK

The MENU / OK button is used to enter the DVR Menu and to select the highlighted command when in the DVR Menu Mode. MENU / OK also begins a playback of a pre-recorded video file from the Play Video : External or Play Video : Internal. The STOP button is used to back out of the menu structure, in one step increments.

3. DVR Menu Arrow Keys

- Up Arrow – used to navigate DVR menu screens when in DVR Menu Mode.
- Left Arrow – fast rewinds pre-recorded file.
- Left Arrow - used to navigate DVR menu screens when in DVR menu mode.
- Right Arrow – used to navigate DVR menu screens when in DVR Menu Mode.
- Right Arrow – fast forwards pre-recorded file.
- Down Arrow – used to navigate DVR menu screens when in DVR Menu Mode.

4. SNAPSHOT

- Records snapshot (JPG) of video image

5. STOP/BACK

- Stops recording.
- Backs out of menu structure, in one step increments, when in DVR Menu Mode.

6. RECORD/PAUSE

- Records live video (MP4)
- Pause pre-recorded video or recording of live video

7. MICROPHONE ON/OFF BUTTON – “MIC”

- Microphone On indicator will be displayed on-screen
- Audio will be recorded to the video when the mic is ON
- Microphone will only work when the DVR is recording video

8. SPEAKER ON/OFF/LOUDNESS BUTTON

- Press to toggle from OFF to LOUD in 6 total steps
- The SPEAKER LOUDNESS indicator is displayed on-screen
- Speaker will only work when playing back a video

4 OPERATING THE SYSTEM

KEYPAD FUNCTIONS (RECORDER) - continued

Recorded videos will be named by their year, month, day and then sequence during the day. For example, the first video made on October 17, 2017 will be named 20171017-00 (00 is the first number in the sequence). All videos will have the file extension .mp4 when shown in lists. Snapshots will be named by their year, month, day and then sequence during the day. For example, the first snapshot made on October 17, 2017 will be named 20171017-00 (00 is the first number in the sequence). All snapshots will have the file extension .jpg when shown in lists.

This page intentionally left blank.

4 OPERATING THE SYSTEM

DPad CONTROLS DIAGRAM



P&T - POPS UP A MENU CONTAIN THE CHOICES TOGGLE SONDE ON/OFF, JOINT INSPECTION AND TOGGLE FREQUENCY HIGH/LOW

CURVED RIGHT ARROW AT TOP OF DPAD - ROTATE PAN & TILT CAMERA CLOCKWISE

RIGHT ARROW AT RIGHT - PAN THE PAN & TILT CAMERA TO THE RIGHT

F+ - FOCUS THE PAN & TILT CAMERA FAR

HOME - HOME THE PAN & TILT CAMERA

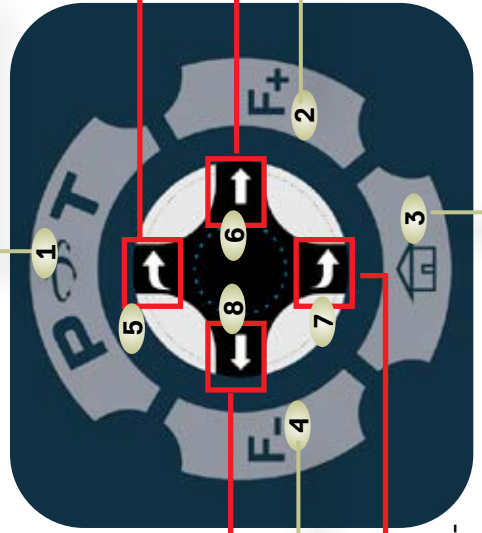

LEFT ARROW AT LEFT - PAN THE PAN & TILT CAMERA TO THE LEFT

F- - FOCUS THE PAN & TILT CAMERA NEAR

CURVED RIGHT ARROW AT BOTTOM OF DPAD - ROTATE PAN & TILT CAMERA COUNTER-CLOCKWISE

DPad FUNCTIONS

The DPad provides the following functionality:

1. **P&T** - P&T - Pops up a menu contain the choices TOGGLE SONDE ON/OFF, JOINT INSPECTION and TOGGLE FREQUENCY HIGH/LOW. These are three selections that might commonly be needed, and are given quick access to.
2. **F+** - Focus the Pan & Tilt camera far
3. **Home** - Home the Pan & Tilt Camera
4. **F-** - Focus the Pan & Tilt camera near
5. **Curved Right Arrow at top of DPad** - Rotate Pan & Tilt Camera clockwise
6. **Right arrow at right** - Pan the Pan & Tilt Camera to the right
7. **Curved Right Arrow at bottom of DPad** - Rotate Pan & Tilt Camera counter-clockwise
8. **Left arrow at left** - Pan the Pan & Tilt Camera to the left

NOTE: Pressing in the diagonal regions between two labeled keys will cause both to occur. For example, pushing down around 2 O'clock on the DPad will cause the Pan & Tilt camera to both rotate clockwise and pan to the right. However, if the Simultaneous Pan/Tilt option is set to NO, only one will occur at a time.

4 OPERATING THE SYSTEM

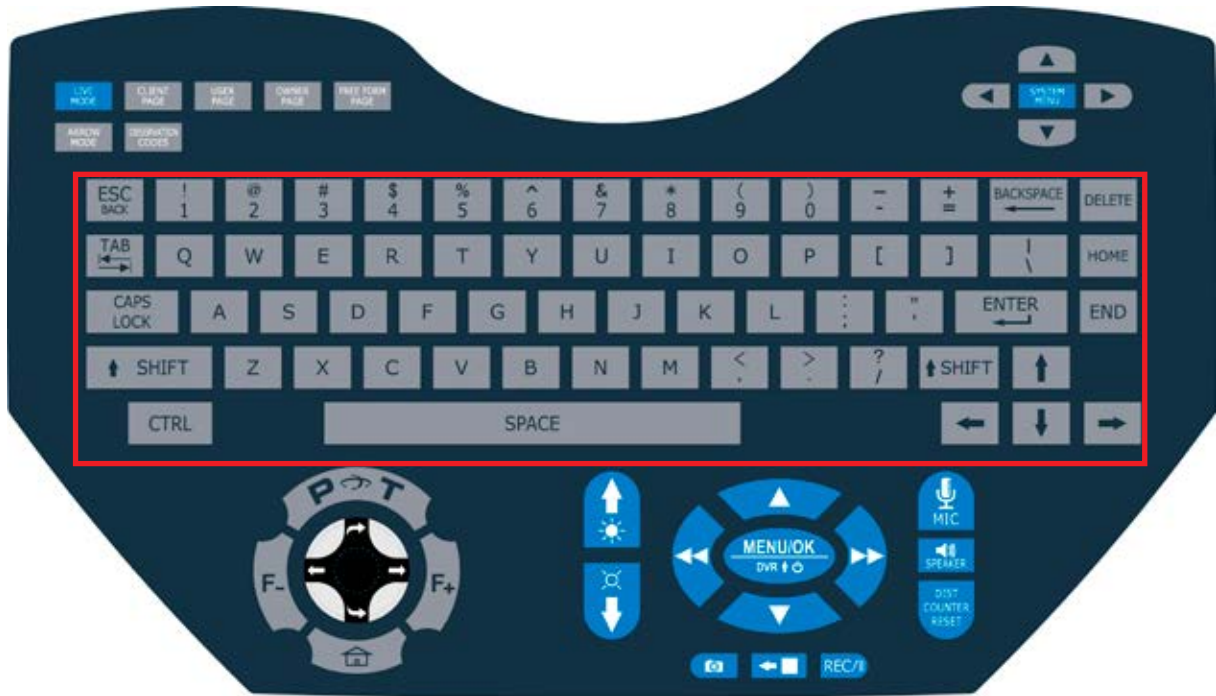

QWERTY KEYBOARD FUNCTIONS

Basic keypad – QWERTY

- 62 characters/keys
- Will function with Titler Pages: “CLIENT PAGE”, “USER PAGE”, “OWNER PAGE”, “FREE FORM”, “ARROW MODE”, “OBSERVATION CODES”
- Will function with the System Menu if required for data entry



MAIN SYSTEM MENU FUNCTIONS

Navigation

- System Menu/OK – Press to display the System Menu and accept the selection
- Up Arrow – Cursor UP to move to the previous selection
- Down Arrow – Cursor DOWN to move to the next selection
- Right Arrow – Press to accept the selection
- Left Arrow – Press to go back up one menu level

Navigation - Additional from QWERTY keypad

- Enter Key– Press to accept the selection
- BackSpace Key – Press to go back up one menu level
- Arrows Up, Down, Right, Left – duplicate function per above arrow descriptions
- ESC - Press to go back up one menu level

4 OPERATING THE SYSTEM

SYSTEM MENU

SYSTEM MENU

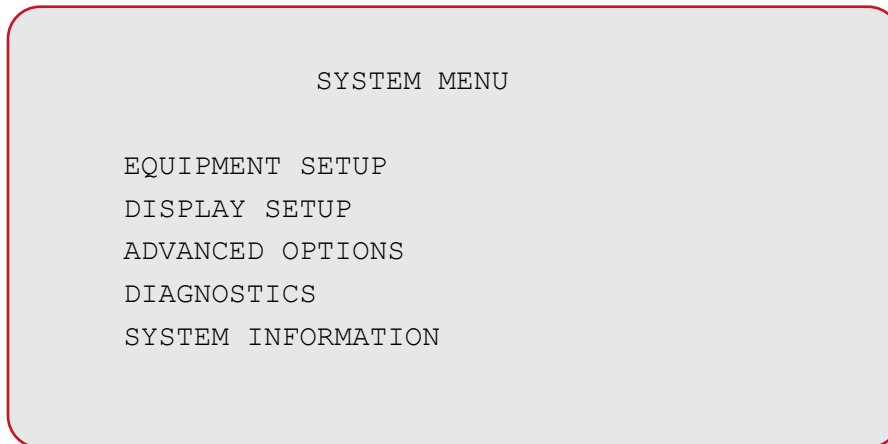

EQUIPMENT SETUP

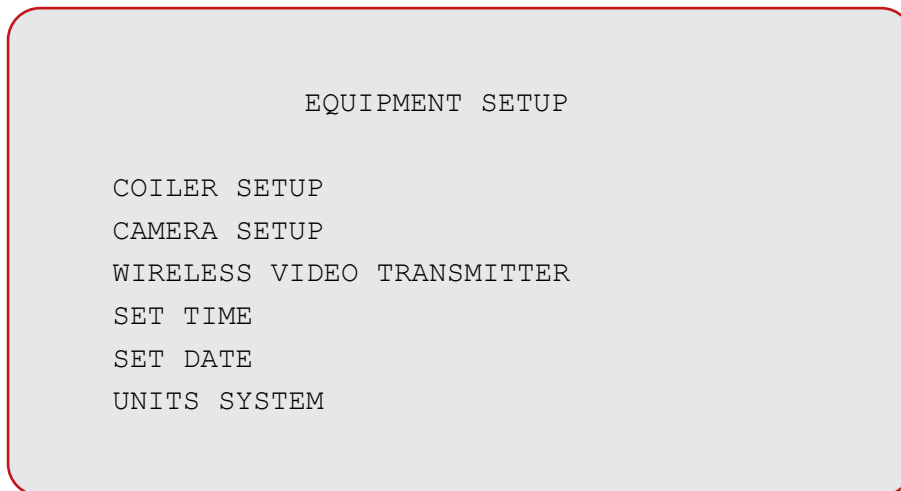

- SET TIME
 - XX:XX AM/PM - NOTE: use the Up Arrow and Down Arrow keys to modify the value in the field displayed. Use the Left Arrow and Right Arrow keys to move within the field. The value is changed upon exiting from the field by pressing <ENTER> or <ESC>.
- SET DATE
 - MM/DD/YY- NOTE: use the Up Arrow and Down Arrow keys to modify the value in the field displayed. Use the Left Arrow and Right Arrow keys to move within the field. The value is changed upon exiting from the field by pressing <ENTER> or <ESC>.

COILER SETUP

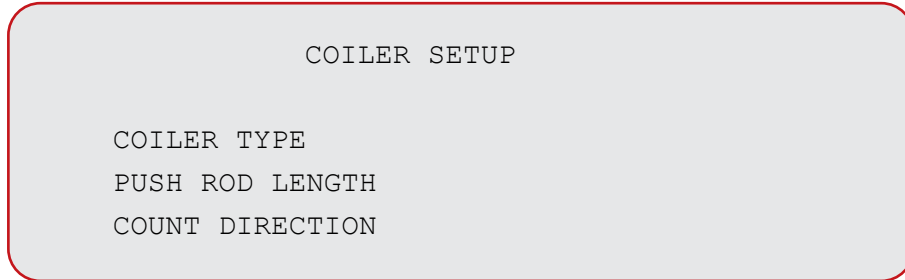

• PUSH ROD LENGTH

- XXX.X - NOTE: enter actual length to one decimal place using the Up Arrow and Down Arrow keys to modify the value in the field displayed. Use the Left Arrow and Right Arrow keys to move within the field. The value is changed upon exiting from the field by pressing <ENTER> or <ESC>.
- Prior to changing the cable's length, all of the cable must be inside the basket/coiler because the firmware assumes this is the case when computing the footage distance.

COILER TYPE

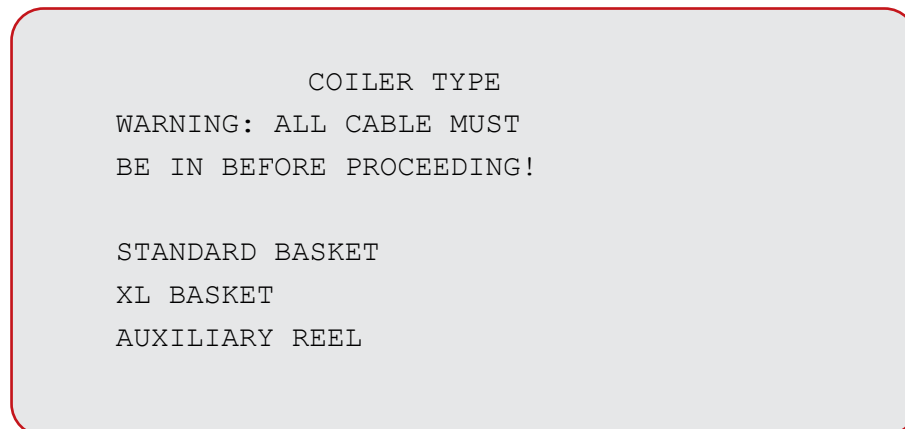

- The selection of 'XL' as the Coiler Type automatically selects large cable, internally.
- The combinations of large coiler with standard cable and standard coiler with large cable are invalid and are currently not selectable.
- Changing the coiler type requires an internal reset of the distance calculation firmware, which requires that all of the cable be retracted into the coiler for the distance to count properly.

COUNT DIRECTION

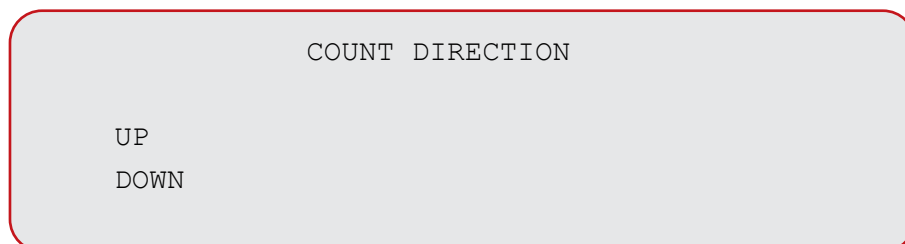

Count direction refers to whether the footage counts up or down when the cable is pulled out.

4 OPERATING THE SYSTEM

SYSTEM MENU

CAMERA SETUP

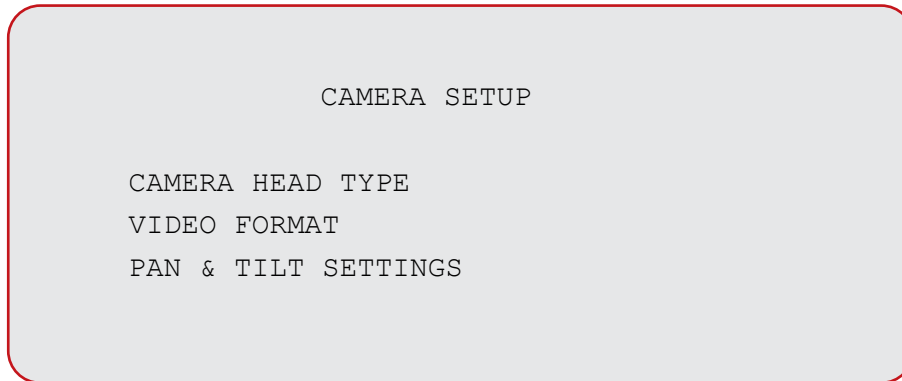

CAMERA HEAD TYPE

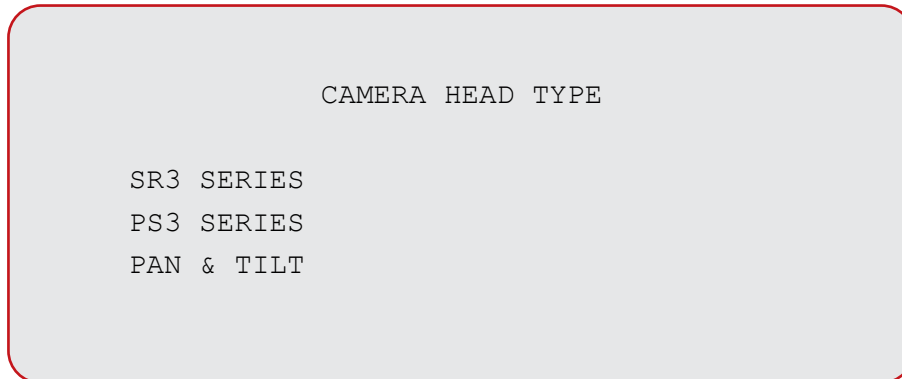

VIDEO FORMAT

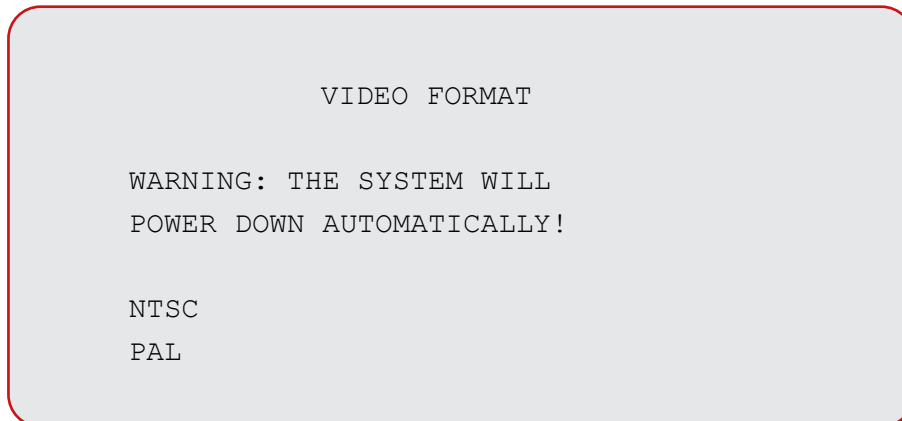

CAMERA SETUP

```
PAN & TILT SETTINGS

SONDE POWER
SONDE FREQUENCY
SIMULTANEOUS PAN/TILT
READ FIRMWARE VERSION XXX
READ PRESSURE XX.X PSI
```

Selecting READ FIRMWARE VERSION will read the camera's firmware version and display it in place of the XXX.

Selecting READ PRESSURE will read the camera's relative pressure and display it in PSI with one decimal point, e.g. 1.3 in place of the XXXXX.

SONDE POWER

```
SONDE POWER

OFF
ON
```

SONDE FREQUENCY

```
SONDE FREQUENCY

512 Hz
8 KHz
```

4 OPERATING THE SYSTEM

SYSTEM MENU

SIMULTANEOUS PAN/TILT

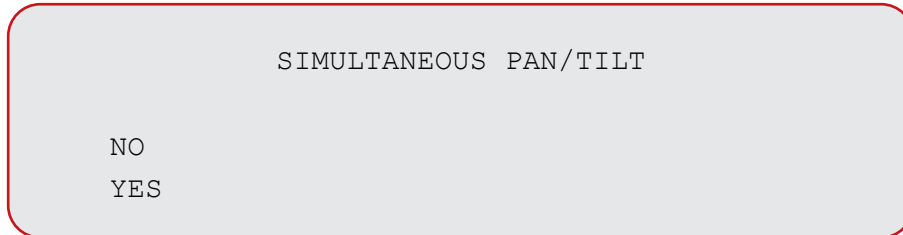

The pan and tilt motors can be run simultaneously (default), or independent of one another.

WIRELESS VIDEO TRANSMITTER

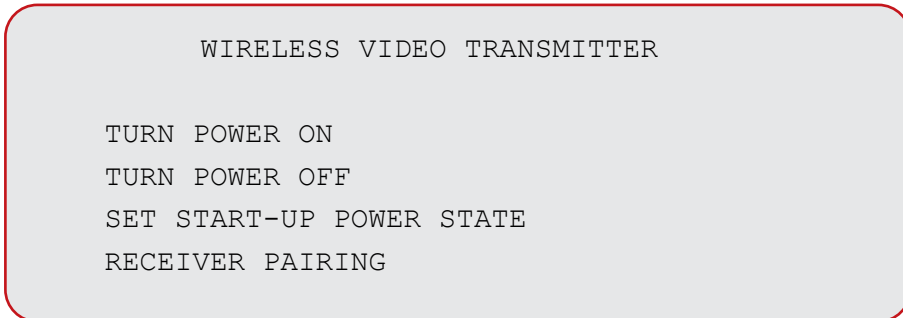

(Note: Turns on/off an optional accessory)

WVT START-UP POWER STATE

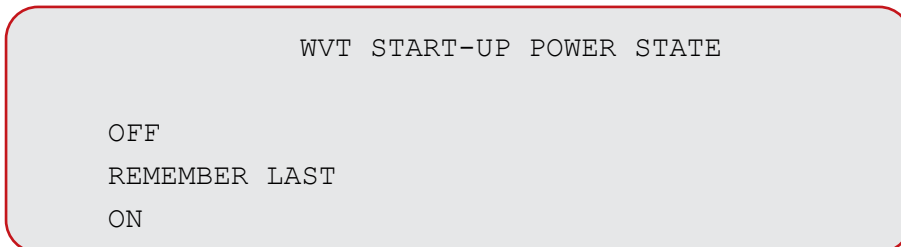

Selecting OFF will set the POWER STATE at start-up to OFF. This means that the operator will have to move to the WIRELESS VIDEO TRANSMITTER MENU and TURN POWER ON whenever he wishes to use the wireless video transmitter.

Selecting ON will set the POWER STATE at start-up to ON. The operator will never have to move to the WIRELESS VIDEO TRANSMITTER MENU again to turn power on. Note that this can impact the battery life if the wireless video transmitter is not needed regularly.

Selecting REMEMBER LAST will cause the system to remember the setting when it is turned off and then use that setting the next time that the system is powered up. This is useful if the operator wants to have the wireless transmitter on until he specifically wants it off or alternately, wants to have the wireless transmitter off until he specifically wants it on.

ADVANCED CONFIGURATION

WVT PAIRING

WVT PAIRING

** PAIRING NOT REQUIRED **

| | ID | | | | |
|-----|----|---|---|---|---|
| ON | ● | | ● | | |
| OFF | | ● | ● | | ● |
| | 1 | 2 | 3 | 4 | 5 |

UNITS SYSTEM

UNITS SYSTEM

U.S./IMPERIAL

METRIC

4 OPERATING THE SYSTEM

ADVANCED CONFIGURATION

DISPLAY SETUP

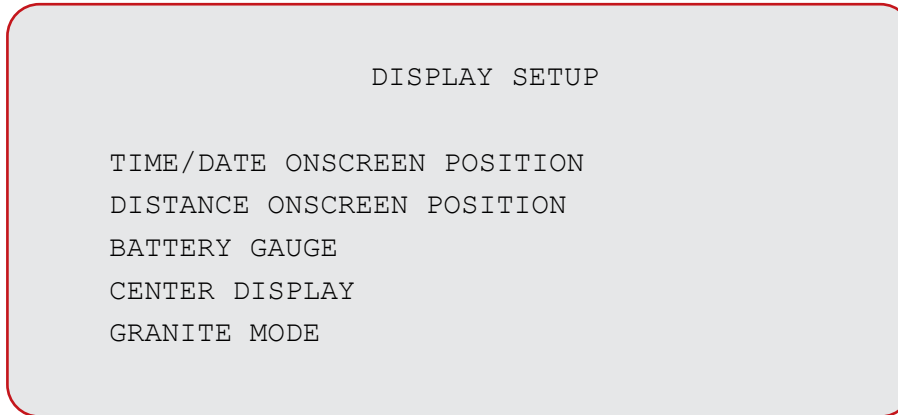

GRANITE MODE

When the Granite Mode screen is entered, both the Camera screen and the DVR are bypassed, which means that 'clean' video straight from the camera is being passed out of the "AV Video Out" to Granite.

The screen title 'GRANITE MODE' is displayed on the ONSCREEN display, for the benefit of the operator, and will not show up on the video being passed to Granite. Also, the DVR is disabled while on this screen, because it is being bypassed and thus, its control buttons won't work.

While the MPlus+ may be connected to either a Granite XP or GraniteNet system, we recommend GraniteNet because it has the ability to not only use the video from the MPlus+, but also the footage information – See Cues Part # CH309 for connecting the two. If using Granite XP, only the video from the MPlus+ will be transferred.

TIME/DATE ONSCREEN POSITION

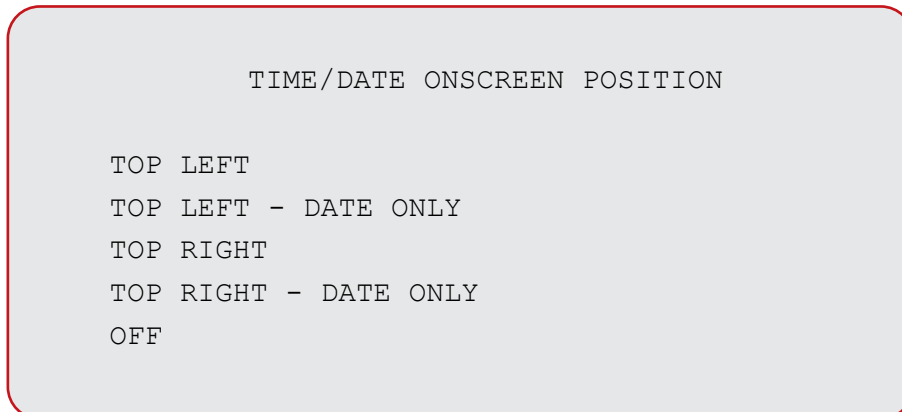

For items that have 'DATE ONLY', only the date will be displayed, not the time.

DISTANCE ONSCREEN POSITIONS

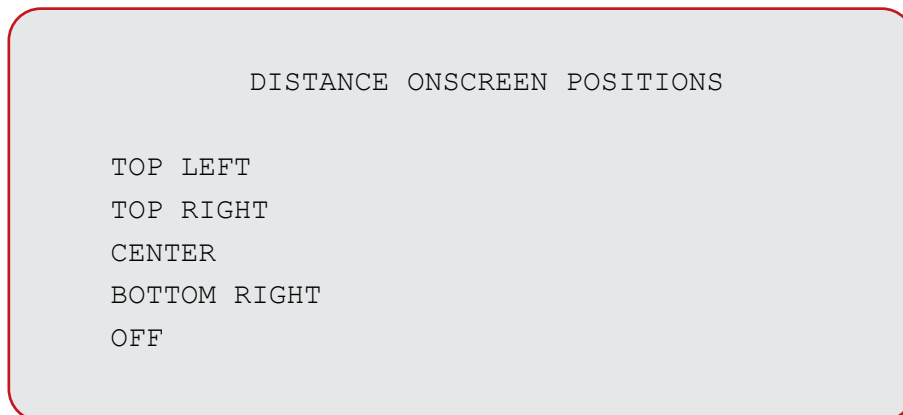

If there is a conflict between the Time/Date onscreen position and the Distance onscreen position whereby they are both chosen to be TOP RIGHT (or TOP LEFT), the Time/Date will be displayed on the top row of the screen and the DISTANCE COUNTER will be displayed on the second row. This applies only to the LIVE MODE screen which has the second row available. All other menu screens and the CLIENT, USER, OWNER AND FREE FORM PAGE screens which use the second row of the screen cause the DISTANCE COUNTER to be displayed on the BOTTOM RIGHT. The same situation occurs whenever the DISTANCE COUNTER is set to be displayed on the CENTER of the screen. It gets moved to the bottom right on anything other than the LIVE MODE screen so that it doesn't obscure information displayed in that area of the display.

BATTERY GAUGE

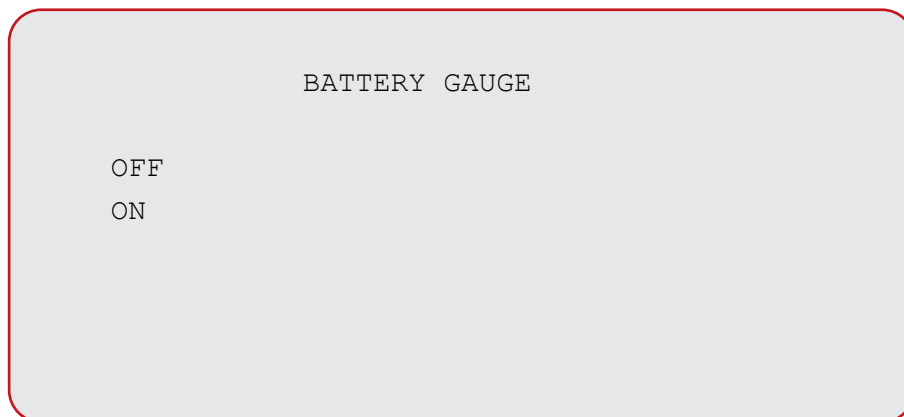

4 OPERATING THE SYSTEM

ADVANCED CONFIGURATION

CENTER DISPLAY

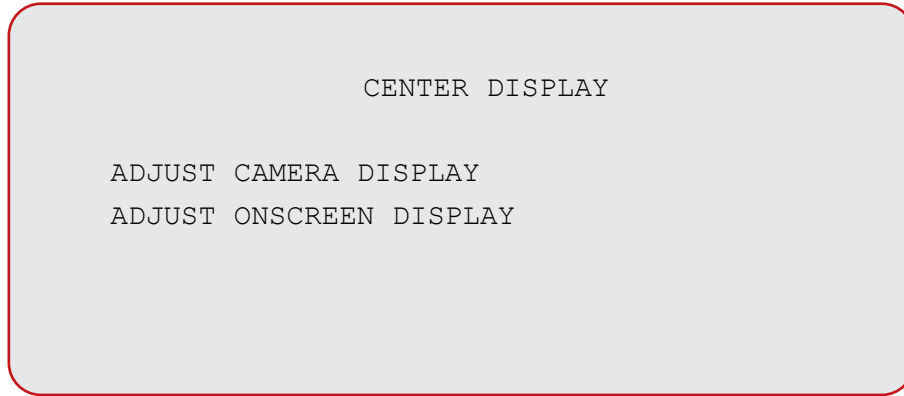

The Up Arrow, Down Arrow, Left Arrow and Right Arrow are used to properly align the CAMERA and ONSCREEN displays such that all their characters fit nicely on the display.

ADVANCED OPTIONS

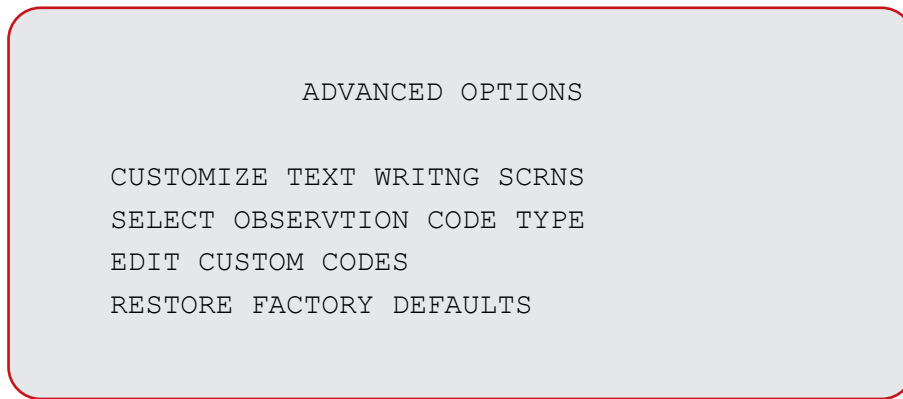

CUSTOMIZE TEXT WRITNG SCRNS

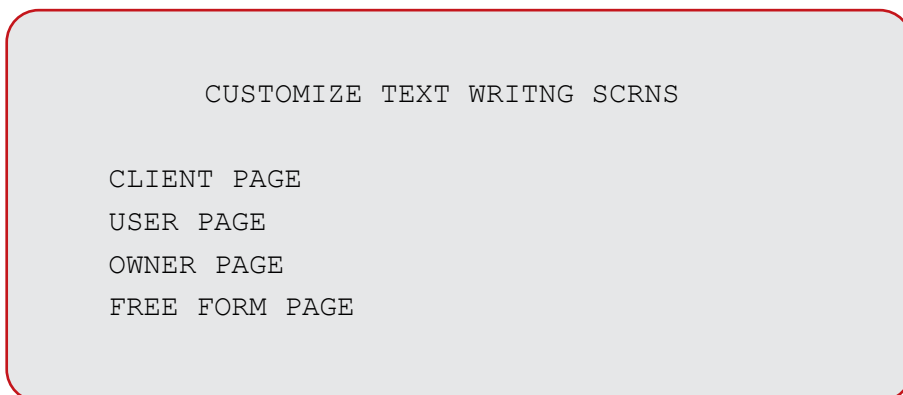

CUSTOMIZE CLIENT PAGE

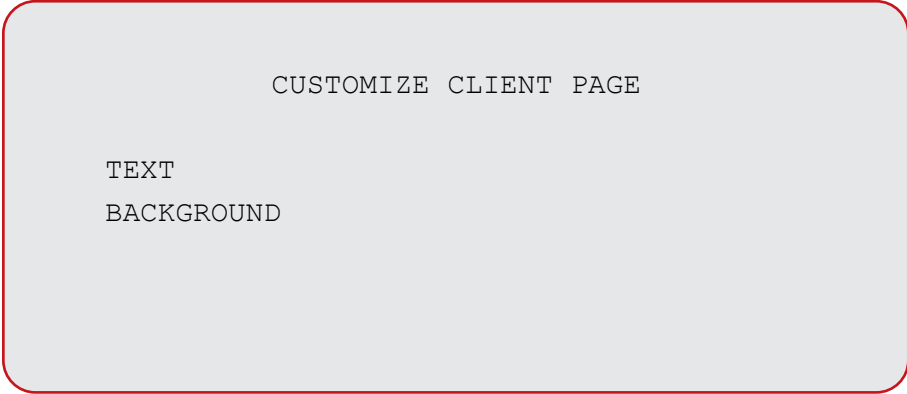

CLIENT PAGE BACKGROUND

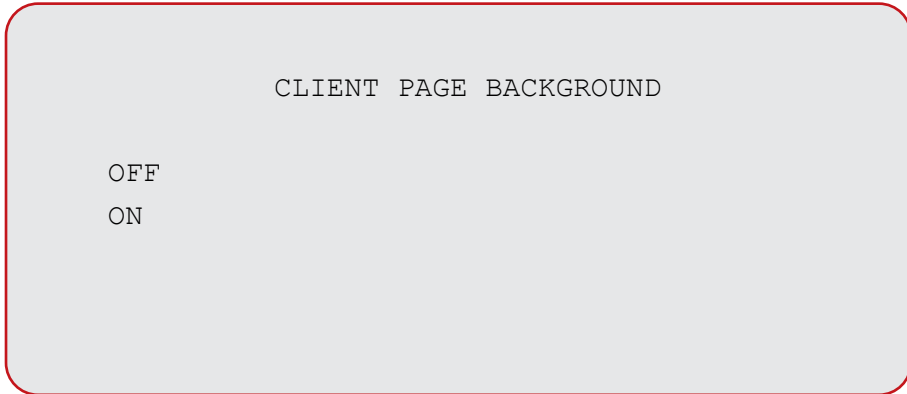

This controls whether the CLIENT PAGE has a video background (OFF, default) or a black background (ON). Setting the background to ON may be useful for recording purposes in order to get all the information to be displayed without having the video image obscure anything.

CUSTOMIZE USER PAGE

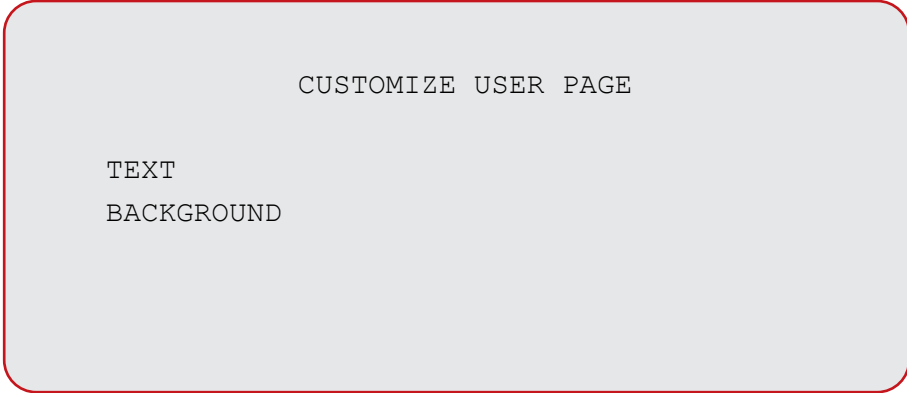

4 OPERATING THE SYSTEM

ADVANCED CONFIGURATION

USER PAGE BACKGROUND

USER PAGE BACKGROUND

OFF
ON

This controls whether the USER PAGE has a video background (OFF, default) or a black background (ON). Setting the background to ON may be useful for recording purposes in order to get all the information to be displayed without having the video image obscure anything.

CUSTOMIZE OWNER PAGE

CUSTOMIZE OWNER PAGE

TEXT
BACKGROUND

OWNER PAGE BACKGROUND

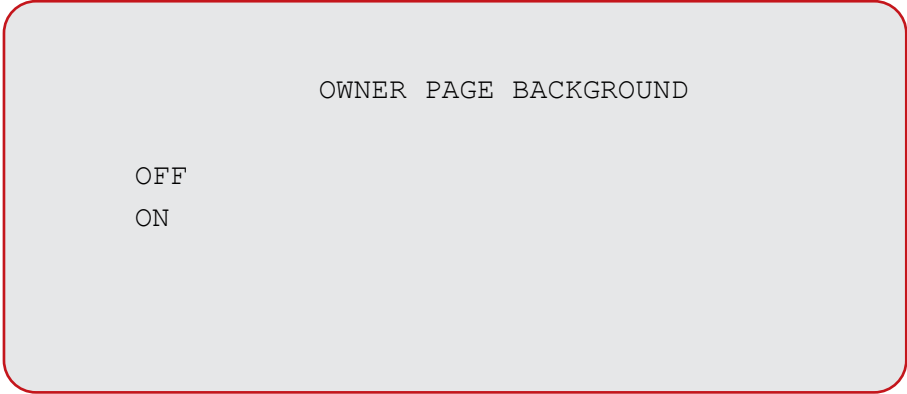

This controls whether the OWNER PAGE has a video background (OFF, default) or a black background (ON). Setting the background to ON may be useful for recording purposes in order to get all the information to be displayed without having the video image obscure anything.

CUSTOMIZE FREE FORM PAGE

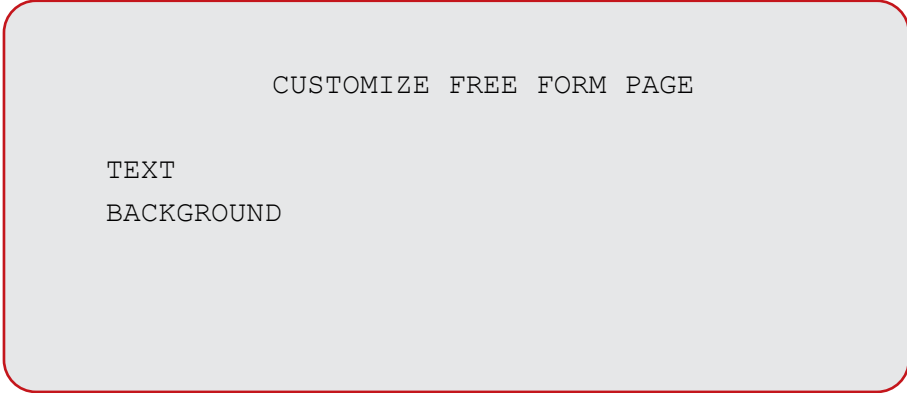

4 OPERATING THE SYSTEM

ADVANCED CONFIGURATION

FREE FORM PAGE BACKGROUND

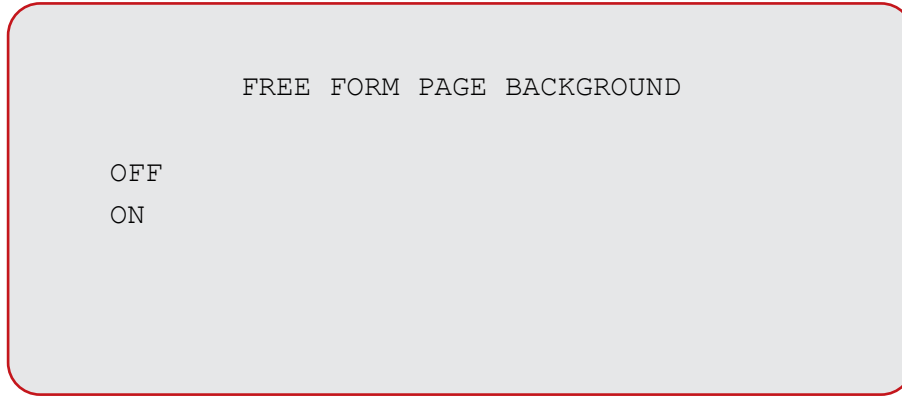

FREE FORM PAGE BACKGROUND

OFF

ON

This controls whether the FREE FORM PAGE has a video background (OFF, default) or a black background (ON). Setting the background to ON may be useful for recording purposes in order to get all the information to be displayed without having the video image obscure anything.

CUSTOMIZE TEXT WRITING SCREENS

There are four customizable text writing screens. The CLIENT, USER and OWNER page are initially set up with field names such as 'NAME', 'ADDR1', etc., that should be relevant to that particular screen. (The FREE FORM page is entirely clear so that it can be set up in any way desired.) Other than the field names are characters displayed as unlocked padlocks. The unlocked padlocks represent the characters that later, an operator can edit (through pressing the CLIENT PAGE, USER PAGE, OWNER PAGE or FREE FORM PAGE buttons). Any character position that doesn't contain an unlocked padlock is not editable by pressing the CLIENT PAGE, USER PAGE, OWNER PAGE or FREE FORM PAGE buttons. Unlocked padlocks characters appear as empty space characters when on the screens displayed by these buttons.

If desired, the customizable text writing screens can be changed by typing over the field names

provided, typing over the unlocked padlock characters, or inputting unlocked padlock characters in positions where they don't currently reside. To type over one of the field names provided, simply move the cursor using the arrow keys to that field and begin typing.

To type over one of the unlocked padlocked characters, simply move the cursor using the arrowkeys to that character and begin typing.

To input an unlocked padlocked character, simply move the cursor using the arrow keys to anyposition and press <CTRL>+<SPACE> simultaneously..

It is advisable that the customizable text writing screens be designed/set up once back in the office, and then the operator in the field will only use the CLIENT PAGE, USER PAGE, OWNER PAGE or FREE FORM PAGE buttons to input relevant data.

Editing of the customizable text writing screens is done on the onscreen display and thus is not recorded to the DVR.

The CLIENT PAGE, USER PAGE, OWNER PAGE and FREE FORM PAGE buttons display screens that are written to the camera display, and thus recorded (assuming the DVR is turned on). When typing characters on any of these pages, it will not wrap around from the bottom line to the top line. Similarly, while pressing <BACKSPACE> on the top line it will not wrap around to the bottom line. However, using the arrow keys will wrap around between the bottom/top and top/bottom of the screen.

4 OPERATING THE SYSTEM

SELECT OBSERVATION CODE TYPE

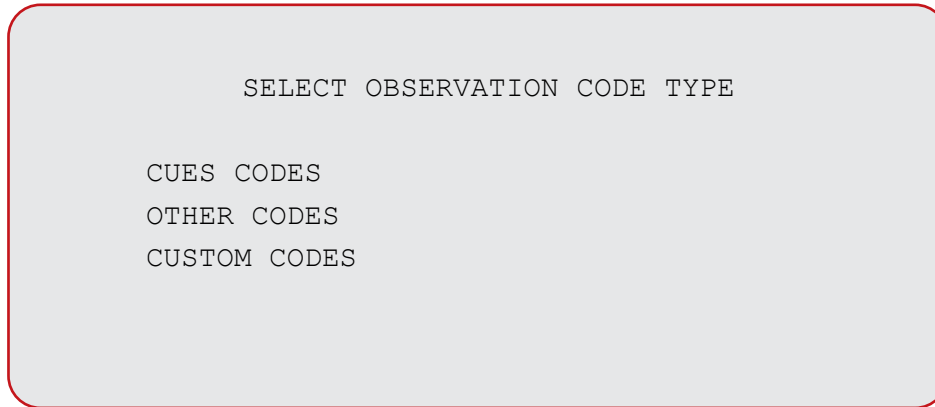

The observation code type selected through this menu affects which set of codes is displayed when the operator presses the OBSERVATION CODES button.

EDIT CUSTOM CODES



Selecting CREATE CUSTOM CODES allows the operator to add up to 50 custom codes of up to 27 characters, each of which will be added to a sorted list that is displayed when the OBSERVATION CODES button is pressed and the observation code type has been set to CUSTOM CODES.

The first character of each custom code input will be converted to upper case, which is needed for display and sorting purposes when showing the observation code list (see section on OBSERVATION CODES later in this manual).

After pressing <ENTER>, the operator may continue adding additional custom codes until the maximum limit (50) is reached.

There is no checking to prevent duplicate codes, although codes will be sorted alphabetically and are case-sensitive (aside from the first character).

Selecting DELETE CUSTOM CODES displays a list of the custom codes and allows the operator to delete a custom code by first pressing <ENTER> to select it, which causes the message to be displayed:

ARE YOU SURE YOU WANT TO PROCEED? PRESS <ENTER> TO DELETE

At which point, pressing <ENTER> will remove that entry from the custom code list.

RESTORE FACTORY DEFAULTS

```
RESTORE FACTORY DEFAULTS

ARE YOU SURE YOU WANT TO
PROCEED?
WARNING: THE SYSTEM WILL
POWER DOWN AUTOMATICALLY!

NO
YES
```

DIAGNOSTICS

```
DIAGNOSTICS

SYSTEM STATUS
PAN & TILT STATUS
MICRO PAN & TILT STATUS
```

4

OPERATING THE SYSTEM

SYSTEM STATUS

```
SYSTEM STATUS

CAMERA: XX.X V  Y.YY A
LIGHTS: XX.X V  Y.YY A
+12V:   XX.X V  Y.YY A
BATT:   XX.X V  Y.YY A
KYBD:   POWER OK
TEMP.:  ZZZ C
```

The SYSTEM STATUS screen displays the voltage and amperage readings of the camera, lights, +12V, battery, and keyboard for diagnostics purposes. Voltage is given with one decimal place whereas amperage is given with two decimal places. It also displays the temperature of the battery in whatever units system is chosen (shown here in Celsius).

PT STATUS

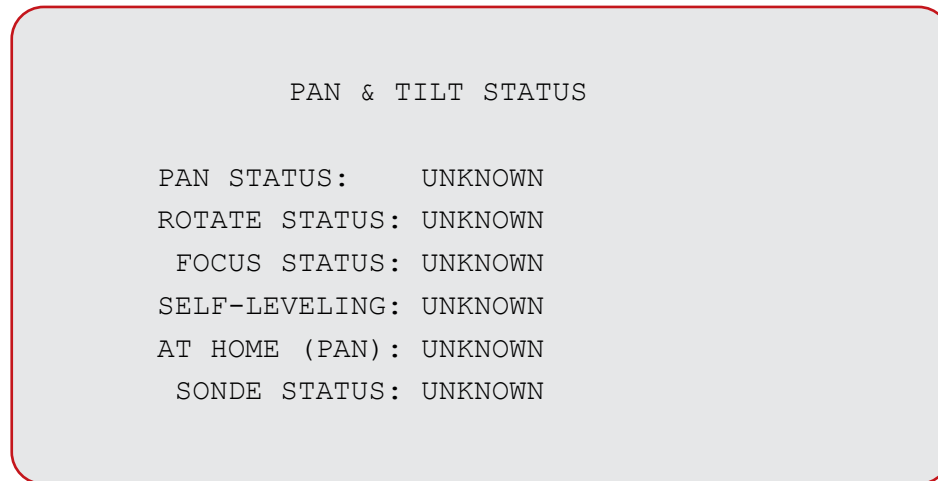

The PT Status screen displays the panning, rotating, focus, self-leveling, at home and sonde status of the PT camera.

Pan status can be LEFT, RIGHT, OFF.

Rotate status can be CCW, CW, OFF.

Focus status can be NEAR, FAR, OFF.

Self-Leveling can be ON or OFF.

At home (Pan) can be YES or NO.

Sonde status can be ON or OFF, 512Hz or 8KHz.

Pressing the Home button on the MPlus+ keyboard both homes the camera and turns on self leveling. Self leveling is turned off whenever rotating, either clockwise or counter-clockwise is selected on the MPlus+ keyboard. At Home is set to NO whenever the operator pans a certain distance left or right from the home position.

If the system is unable to read the PT camera, the values for these fields will be set to their initial values 'UNKNOWN'.

4 OPERATING THE SYSTEM

MICRO PAN & TILT STATUS

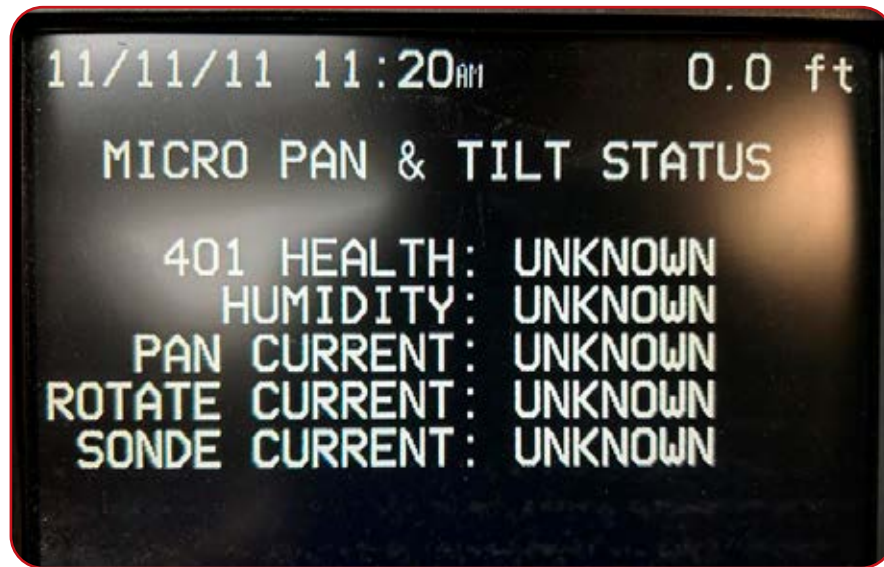

The UPT status screen displays 401 Health, Relative Humidity, Pan Current, Rotate Current, and Sonde Current. Current is displayed in milli-Amps. 401 health determines if the 401 board is working. These values are updated periodically and automatically. If the system cannot read from the camera, then the values for the fields will be set to their initial values 'UNKNOWN'.

This page intentionally left blank.



OPERATING THE SYSTEM

SYSTEM INFORMATION

```
SYSTEM INFORMATION

FIRMWARE VERSION
USAGE TIME
COPYRIGHT
```

FIRMWARE VERSION

```
FIRMWARE VERSION

R11
```

SYSTEM TOTAL USAGE TIME

```
SYSTEM TOTAL USAGE TIME

Hours: 3
Minutes: 51
```

NOTE: The System Total Usage Time is maintained through firmware updates.

COPYRIGHT

```
COPYRIGHT

CUES, INC.
3600 RIO VISTA AVENUE
ORLANDO, FLORIDA 32805
PHONE 800-327-7791
FAX 407-425-1569
WWW.CUESINC.COM
```

The copyright screen contains contact information for the vendor.



PRECONFIGURED TEXT WRITING SCREENS/ARROW MODE/OBSERVATION CODES

- LIVE MODE - video is displayed on the screen without any text
- CLIENT PAGE - Select to edit or view Client information
- USER PAGE - Select to edit or view User information
- OWNER PAGE - Select to edit or view Owner information
- FREE FORM PAGE - Select to edit or view Free Form information

On each of these four screens, pressing <CTRL><DELETE> will clear all of the operator entered data so that it may quickly set up with new information.

- ARROW MODE - an arrow is displayed on the screen. The arrow can be positioned anywhere on the screen to help identify voids, defects, or other observations in the pipeline.

Pressing any of these four buttons brings up the named screen in a read-only mode. This means that there is no cursor flashing and characters may not be inserted/deleted. Read-only mode is available so that these screens may be overlaid on the video screen for recording purposes. A message will be displayed for two seconds indicating that pressing the same button again will toggle into an editable mode, where text may be inserted and deleted. On the editable screen a blinking cursor indicates where the next character will be inserted.

4 OPERATING THE SYSTEM

When the ARROW MODE button is pressed, a blinking arrow is displayed in the middle of the display, pointing right. This blinking arrow may be moved around using the arrow keys. When an arrow key is pressed, it will either change the direction of the blinking arrow displayed on the screen, or move the blinking arrow on the screen one position vertically or horizontally. If the arrow key pressed is different from the current direction of the blinking arrow displayed, it will change the blinking arrow's direction. If the arrow key pressed is the same as the current direction of the blinking arrow displayed it will move the blinking arrow on the screen one position in that direction.

The blinking arrow on the screen should be positioned to point at the observation desired. Once it is properly positioned, pressing <ENTER> will cause the blinking arrow to stop blinking and be moved from the ONSCREEN to the CAMERA display, where it will be recorded (assuming the DVR is on).

- OBSERVATION CODES - press to select and enter observation codes while recording the inspection.

Selecting a CUES CODE or CUSTOM CODE observation code:

When the operator has made CUES CODES or CUSTOM CODES his observation code type and then presses the OBSERVATION CODES button, a list of codes is displayed alphabetically with an arrow pointing at the middle line of the display. The operator may move up and down through the list using the Up Arrow or Down Arrow keys. However, he may more easily move about the list by pressing the first character of the desired code and the list will jump to that section of the list (or the nearest letter prior to that letter).

In the CUES CODES list items that are followed by '...' have a secondary list from which to select.

Moving around the lists is all displayed in the ONSCREEN display, which will not be recorded.

In both the CUES CODES and CUSTOM CODES pressing <ENTER> will select the code (or take one to the secondary list, at which time pressing <ENTER> again will select the code). When a code is selected, it is written to the top one or two lines of the CAMERA display which will be recorded (assuming the DVR is on).

Selecting an OTHER CODES observation code:

When the operator has made OTHER CODES his observation code type and then presses the OBSERVATION CODES button, a list of codes is displayed alphabetically with an arrow pointing at the middle line of the display. The operator may move up and down through the list using the Up Arrow or Down Arrow keys. However, he may more easily move about the list by pressing the first character of the desired code and the list will jump to that section of the list (or the nearest letter prior to that letter). If a match is found, that first letter will start blinking. He may continue pressing letters (second, third, fourth, etc., and the list will further be sorted and the additional matching letters will start blinking. Pressing <BACKSPACE> will move back a letter and again, re-sort the list based on what has been selected thus far.

Moving around the lists is all displayed in the ONSCREEN display, which will not be recorded.

Pressing <ENTER> at any time will move to the secondary (code expanded) definition of the code, at which time <ENTER> again will select the code). When a code is selected, it is written to the top one or two lines of the CAMERA display which will be recorded (assuming the DVR is on).

The operator may choose to position an arrow either prior to, or after displaying an observation code, and vice-versa. In the former case, the arrow will stay displayed on the camera display while the operator selects and displays an observation code. In the latter case, the observation code will stay displayed while the operator positions and displays an arrow. This can be quite useful if the same observation appears in more than place in the image displayed, such that the operator wants to record two separate arrows with the same observation code. Or alternately, if the operator wants to record two different observation codes with the same arrow, he may choose to do that.

In other words, neither the arrow or observation code are removed from the camera display unless the operator repeats the operation (selecting an observation code with one already displayed removes the former observation code and selecting ARROW MODE with an arrow already displayed removes the former arrow), or exits entirely to the SYSTEM MENU, LIVE MODE, or one of the CLIENT, USER, OWNER or FREE FORM PAGES.

| OTHER CODES | | | |
|-------------|--------------------------------|--------|---------------------------------|
| CODE | DESCRIPTION | | |
| ACB | Catch Basin | DAGS | Deposits Attached Grease |
| ACOH | Cleanout House | DAR | Deposits Attached Ragging |
| ACOM | Cleanout Mainline | DAZ | Deposits Attached Other |
| ACOP | Cleanout Propertyline | DI | Dropped Invert |
| ACOS | Cleanout Saddle | DNF | Deposits Ingressed Fine |
| ADP | Discharge Point | DNGV | Deposits Ingressed Gravel |
| AEP | End of Pipe | DNZ | Deposits Ingressed Other |
| AJB | Junction Box | DSC | Deposits Settled Compacted |
| AM | Meter | DSF | Deposits Settled Fine |
| AMH | Manhole | DSGV | Deposits Settled Gravel |
| AML | Mainline | DSZ | Deposits Settled Other |
| AOC | Special Chamber | FBEMD | Fitting Mitered Bend Down |
| ATC | Tee Connection | FBEML | Fitting Mitered Bend Left |
| AW | Wye | FBEMLD | Fitting Mitered Bend Left Down |
| AWA | Wastewater Access Device | FBEMLU | Fitting Mitered Bend Left Up |
| AWD | Double Wye | FBEMR | Fitting Mitered Bend Right |
| AWW | Wet Well | FBEMRD | Fitting Mitered Bend Right Down |
| B | Broken | FBEMRU | Fitting Mitered Bend Right Up |
| BSV | Broken Soil Visible | FBEMU | Fitting Mitered Up |
| BVV | Broken Void Visible | FBESD | Fitting Sweep Bend Down |
| CC | Crack Circumferential | FBESL | Fitting Sweep Bend Left |
| CH2 | Crack Longitudinal Hinge, 2 | FBESLD | Fitting Sweep Bend Left Down |
| CH3 | Crack Longitudinal Hinge, 3 | FBESLU | Fitting Sweep Bend Left Up |
| CH4 | Crack Longitudinal Hinge, 4 | FBESR | Fitting Sweep Bend Right |
| CL | Crack Longitudinal | FBESRD | Fitting Sweep Bend Right Down |
| CM | Crack Multiple | FBESRU | Fitting Sweep Bend Right Up |
| CS | Crack Spiral | FBESU | Fitting Sweep Bend Up |
| D | Deformed | FC | Fracture Circumferential |
| DAE | Deposits Attached Encrustation | | |

| OTHER CODES | | | |
|-------------|--------------------------------|-------|---|
| CODE | DESCRIPTION | | |
| FCA | Fitting Cap | ISSRH | Intruding Sealing Ring Hanging |
| FCAF | Fitting Cap Fitting | ISSRL | Intruding Sealing Ring Loose/ Poorly Fitting |
| FCAS | Fitting Cap Seal | ISZ | Intruding Sealing Other |
| FH2 | Fracture Longitudinal Hinge, 2 | IW | Infil Weeper |
| FH3 | Fracture Longitudinal Hinge, 3 | JAL | Joint Angular Large |
| FH4 | Fracture Longitudinal Hinge, 4 | JAM | Joint Angular Medium |
| FL | Fracture Longitudinal | JOL | Joint Offset Large |
| FM | Fracture Multiple | JOM | Joint Offset Medium |
| FRV | Fitting Vertical Riser | JSL | Joint Separated Large |
| FS | Fracture Spiral | JSM | Joint Separated Medium |
| FTDS | Fitting Double Sweep Tee | KD | Buckling Dimpling |
| FTS | Fitting Sweep Tee | KI | Inverse Curvature |
| GRT | Grout done at Location | KW | Buckling Wall |
| GTFJ | Grout Air Test Fail Joint | LD | Alignment Down |
| GTFL | Grout Air Test Fail Lateral | LFAC | Lining Failure Abandoned Connection |
| GTPJ | Grout Air Test Pass Joint | LFAS | Lining Failure Annular Space |
| GTPL | Grout Air Test Pass Lateral | LFB | Lining Failure Blistered |
| GTUJ | Grout Air Test Unable Joint | LFBK | Lining Failure Buckled |
| GTUL | Grout Air Test Unable Lateral | LFBU | Lining Failure Bulges |
| H | Hole | LFCS | Lining Failure Connection Cut Shifted |
| HSV | Hole Soil Visible | LFD | Lining Failure Detached |
| HVV | Hole Void Visible | LFDC | Lining Failure Discoloration |
| ID | Infil Dropper | LFDE | Lining Failure Defective End |
| IG | Infil Gusher | LFDL | Lining Failure Delaminating |
| IR | Infil Runner | LFOC | Lining Failure Overcut Connection |
| IS | Infil Stain | LFPH | Lining Failure Pinhole |
| ISGT | Intruding Sealing Grout | | |
| ISSR | Intruding Sealing Ring | | |
| ISSRB | Intruding Sealing Ring Broken | | |

| OTHER CODES | | | |
|-------------|------------------------------------|------|----------------------------------|
| CODE | DESCRIPTION | | |
| LFRS | Lining Failure Resin Slug | OBM | Obstacle Pipe Material |
| LFUC | Lining Failure Undercut Connection | OBN | Obstacle Construction Debris |
| LFW | Lining Failure Wrinkled | OBP | Obstacle External Pipe or Cable |
| LFZ | Lining Failure Other | OBR | Obstacle Rocks |
| LL | Alignment Left | OBS | Obstacle Built Into Structure |
| LLD | Alignment Left Down | OBZ | Obstacle Other |
| LLU | Alignment Left Up | RBB | Roots Ball Barrel |
| LR | Alignment Right | RBC | Roots Ball Connection |
| LRD | Alignment Right Down | RBJ | Roots Ball Joint |
| LRU | Alignment Right Up | RBL | Roots Ball Lateral |
| LU | Alignment Up | RFB | Roots Fine Barrel |
| MCU | Camera Underwater | RFC | Roots Fine Connection |
| MGO | General Observation | RFJ | Roots Fine Joint |
| MGP | General Photo | RFL | Roots Fine Lateral |
| MJL | Joint Length Change | RMB | Roots Medium Barrel |
| MLC | Lining Change | RMC | Roots Medium Connection |
| MMC | Material Change | RMJ | Roots Medium Joint |
| MSA | Abandoned Survey | RML | Roots Medium Lateral |
| MSC | Shape or Size Change | RPL | Repair Localized Liner |
| MWL | Water Level | RPLD | Repair Localized Liner Defective |
| MWLS | Water Level Sag | RPP | Repair Patch |
| MWM | Water Mark | RPPD | Repair Patch Defective |
| MYN | Dye Test Not Visible | RPR | Repair Point Pipe Replaced |
| MYV | Dye Test Visible | RPRD | Repair Point Defective |
| OBB | Obstacle Brick | RPZ | Repair Other |
| OBC | Obstacle Thru Connection | RPZD | Repair Other Defective |
| OBI | Obstacle Intruding Thru Wall | RTB | Roots Tap Barrel |
| OBJ | Obstacle In Joint | RTC | Roots Tap Connection |
| | | RTJ | Roots Tap Joint |

| OTHER CODES | | | |
|-------------|---|------|---|
| CODE | DESCRIPTION | | |
| RTL | Roots Tap Lateral | SRCC | Surface Reinforcement Corroded Chemical |
| SAM | Surface Aggregate Missing | | |
| SAMC | Surface Aggregate Missing Chemical | SRCM | Surface Reinforcement Corroded Mechanical |
| SAMM | Surface Aggregate Missing Mechanical | SRCZ | Surface Reinforcement Corroded Unknown |
| SAMZ | Surface Aggregate Missing Unknown | SRI | Surface Roughness Increased |
| SAP | Surface Aggregate Projecting | SRIC | Surface Roughness Increased Chemical |
| SAPC | Surface Aggregate Projecting Chemical | SRIM | Surface Roughness Increased Mechanical |
| SAPM | Surface Aggregate Projecting Mechanical | SRIZ | Surface Roughness Increased Unknown |
| SAPZ | Surface Aggregate Projecting Unknown | SRP | Surface Reinforcement Projecting |
| SAV | Surface Aggregate Visible | SRPC | Surface Reinforcement Projecting Chemical |
| SAVC | Surface Aggregate Visible Chemical | SRPM | Surface Reinforcement Projecting Mechanical |
| SAVM | Surface Aggregate Visible Mechanical | SRPZ | Surface Reinforcement Projecting Unknown |
| SAVZ | Surface Aggregate Visible Unknown | SRV | Surface Reinforcement Visible |
| SCP | Surface Corrosion Metal Pipe | SRVC | Surface Reinforcement Visible Chemical |
| SMW | Surface Missing Wall | SRVM | Surface Reinforcement Visible Mechanical |
| SMWC | Surface Missing Wall Chemical | SRVZ | Surface Reinforcement Visible Unknown |
| SMWM | Surface Missing Wall Mechanical | SSS | Surface Spalling |
| SMWZ | Surface Missing Wall Unknown | SSSC | Surface Spalling Chemical |
| SRC | Surface Reinforcement Corroded | SSSM | Surface Spalling Mechanical |

| CUES BASE CODES | |
|------------------------------|-----------------------|
| Abandoned Survey | |
| | |
| Bricks Missing | Severe |
| | Medium |
| | Light |
| | |
| Broken | Hole |
| | Void Visible - Large |
| | Void Visible - Medium |
| | Void Visible - Small |
| | Soil Visible - Large |
| | Soil Visible - Medium |
| | Soil Visible - Small |
| | |
| Camera Under Water | |
| | |
| Catch Basin | |
| | |
| Cavity | Small |
| | Medium |
| | Large |
| | |
| Cleaned | |
| | |
| Cleanout | |
| | |
| Collapsed | Large |
| | Medium |
| | Small |
| | |
| Continue Against Flow | |
| | |
| Continue With Flow | |
| | |

4

OPERATING THE SYSTEM

| CUES BASE CODES | |
|-------------------------------|-----------------------|
| Crack | Multiple - Narrow |
| | Longitudinal - Narrow |
| | Circular - Narrow |
| | Spiral - Wider |
| | Multiple - Wider |
| | Longitudinal - Wider |
| | Circular - Wider |
| | Spiral - Narrow |
| Dead End | |
| | |
| Debris | >30% |
| | <=30% |
| | <=20% |
| | <=10% |
| | |
| Deformed | >10% |
| | <=10% |
| | |
| Deposits | Severe |
| | Medium |
| | Light |
| | |
| Discharge Point | |
| | |
| Dye Test | Visible |
| | Not Visible |
| | |
| End of Pipe | |
| | |
| Factory Defective Pipe | |
| | |
| Flattened | Severe |
| | Medium |
| | Light |

| CUES BASE CODES | |
|--------------------------------|----------------------|
| Grease | Severe |
| | Medium |
| | Light |
| Grouted | |
| | |
| | |
| Infiltration | Severe |
| | Medium |
| | Light |
| Intruding Sealing Grout | Hanging Gasket >30% |
| | Hanging Gasket <=30% |
| | Hanging Gasket <=20% |
| Intruding Sealing Ring | Hanging Gasket <=10% |
| | |
| | |
| Intruding Sealing Ring | Hanging Gasket >30% |
| | Hanging Gasket <=30% |
| | Hanging Gasket <=20% |
| | Hanging Gasket <=10% |
| Joint - Angular | |
| | Large |
| | Medium |
| Joint - Gasket | Small |
| | |
| | |
| Joint - Gasket | Severe |
| | Medium |
| | Light |
| Joint - Infiltration | |
| | Severe |
| | Medium |
| Joint - Infiltration | Light |
| | |
| | |
| Joint Offset | |
| | Large |
| | Medium |
| Joint Offset | Small |
| | |

4

OPERATING THE SYSTEM

| CUES BASE CODES | |
|-----------------------------|------------------------|
| Joint - Separated | Large |
| | Medium |
| | Small |
| | |
| Junction Box | |
| | |
| Lateral | Capped |
| | Live Connection |
| | |
| Lateral Abandoned -Unsealed | |
| | |
| Lateral Blocked | |
| | |
| Lateral Connection Prblm | Blocked |
| | Protruding |
| | Pipe Damaged |
| | Factory Defective Pipe |
| | |
| Lining Failure | Other |
| | Undercut connection |
| | Overcut connection |
| | Defective end |
| | Detached |
| | Connection cut shifted |
| | Buckled |
| | Blistered lining |
| | Abandon connection |
| | |
| Meter | |
| | |
| Not accessible | |
| | |
| Pipe Continue | |
| | |
| Pipe Size | |

| CUES BASE CODES | |
|---------------------------------|-----------------------------|
| Pipe Type | |
| | |
| Root | Heavy |
| | Medium |
| | Light |
| | |
| Root-in-Joint | Light |
| | Medium |
| | Heavy |
| | |
| Root-in-Lateral | Light |
| | Medium |
| | Heavy |
| | |
| Sag | Severe |
| | Medium |
| | Light |
| Satisfactory | |
| | |
| Start Against Flow | |
| | |
| Start Lateral Inspection | |
| | |
| Start With Flow | |
| | |
| Status - | |
| | |
| Stop | |
| | |
| Surface Damage | Sev Mat Damg- Mechan Problm |
| | Med Mat Damg- Mechan Problm |
| | Lit Mat Damg- Mechan Problm |
| | Sev Mat Damg- Chemcl Problm |
| | Med Mat Damg- Chemcl Problm |
| | Lit Mat Damg- Chemcl Problm |

4

OPERATING THE SYSTEM

| CUES BASE CODES | |
|-----------------------|-----------|
| | |
| Tee Connection | |
| | |
| Vermin | Other |
| | Mice |
| | Rat |
| | Cockroach |
| | |
| Water Level | 100% |
| | >=75% |
| | >=50% |
| | >=25% |
| | < 25% |
| | |
| Water Mark | >=75% |
| | >=50% |
| | |
| Wet Well | |
| | |

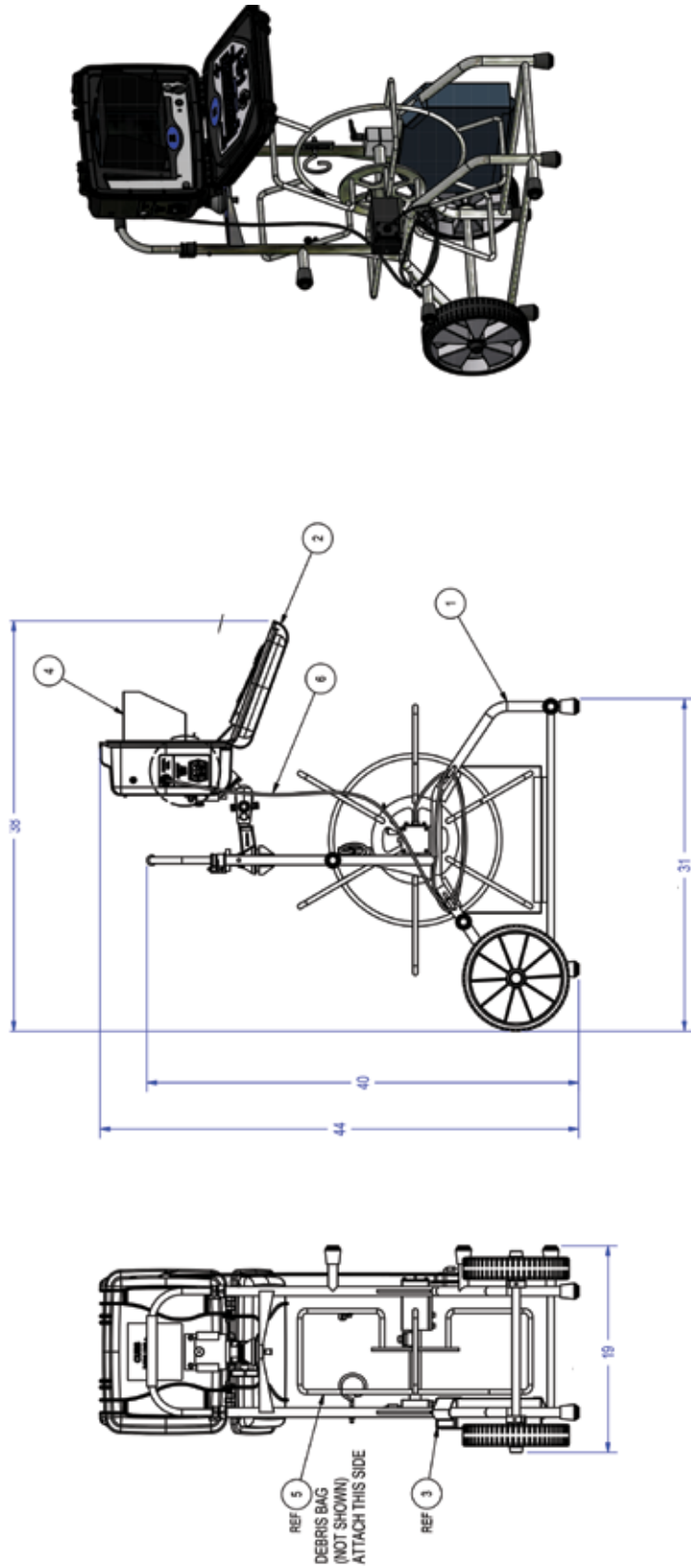

| ITEM | QTY | DESCRIPTION | PART NO. | MTL |
|------|-----|--------------------------------------|--------------------|-------------------------------------|
| 8 | 1 | CAP VINYL .625 DIA. W/ 8 DIA TETHER | EG2409 | REF ONLY P/O CH900 |
| 8 | 1 | CAMERA ASSY SELF UPRIGHTING/NTSC | SR330 | REF ONLY NOT SHOWN |
| 7 | 1 | PUSH CABLE ASSY MPLUS | CH333-10H THRU 40H | REF ONLY NOT SHOWN |
| 6 | 1 | CABLE ASSY CONTR R/C-COILER W/ MPLUS | CH070 | REF ONLY P/O CH900 |
| 5 | 1 | DEBRIS BAG COILER BASKET/LAT MPLUS | CH082 | OPTIONAL |
| 4 | 1 | SUN SHIELD, LCD, M-PLUS SYSTEM | CH083 | REF ONLY P/O CH900 |
| 3 | 1 | ACCESSORY BAG, LATERAL PUSH SYSTEM | CH061 | REF ONLY P/O CH900 |
| 2 | 1 | ASSY V2 CONTROL UNIT, MPLUS* | CH375 | REF ONLY WIRELESS UNITS USE CH305-1 |
| 1 | 1 | COILER ASSEMBLY, LATERAL PUSH SYSTEM | CH330 | REF ONLY |

CH060, COILER WEIGHT MINUS PUSH CABLE = 31.0 LBS.
 CH0645, CONTROL UNIT CASE WEIGHT = 14 LBS.
 CH00X, PUSH CABLE WEIGHT PER 100 FEET = 8.5 LBS.
 SR320, SELF UPRIGHT CAMERA = .55 LBS.

Figure 1a. MPlus+ System Interface, CH950-INST, Rev. D

5

EXPLODED VIEW DRAWINGS & BOM'S



FIGURE 2.1 - EC2409
PROTECTIVE CAP (REF ONLY)
PART OF CH900

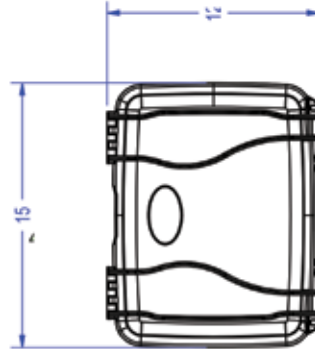
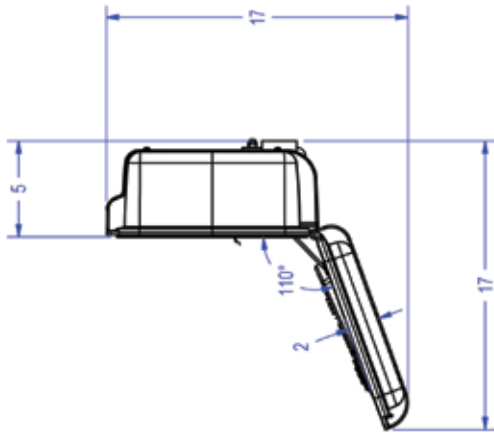

CH304/5, CONTRL UNIT ASSY., MPLUS+
WEIGHT: 14 LBS.

Figure 1b. MPlus+ System Interface, CH950-INST, Rev. D

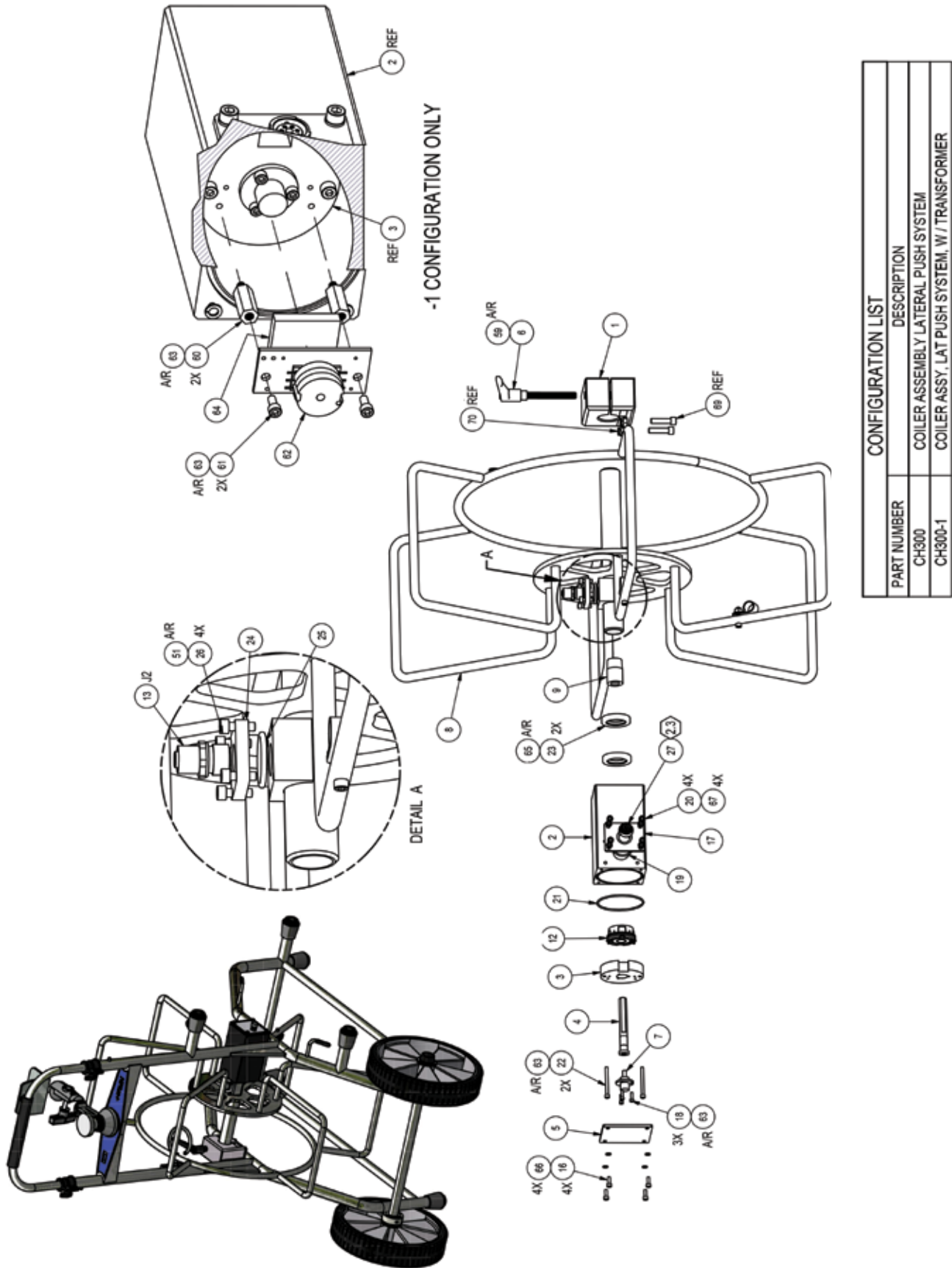

Figure 2a. Lateral Push System Coiler Assembly, CH300, Rev. H

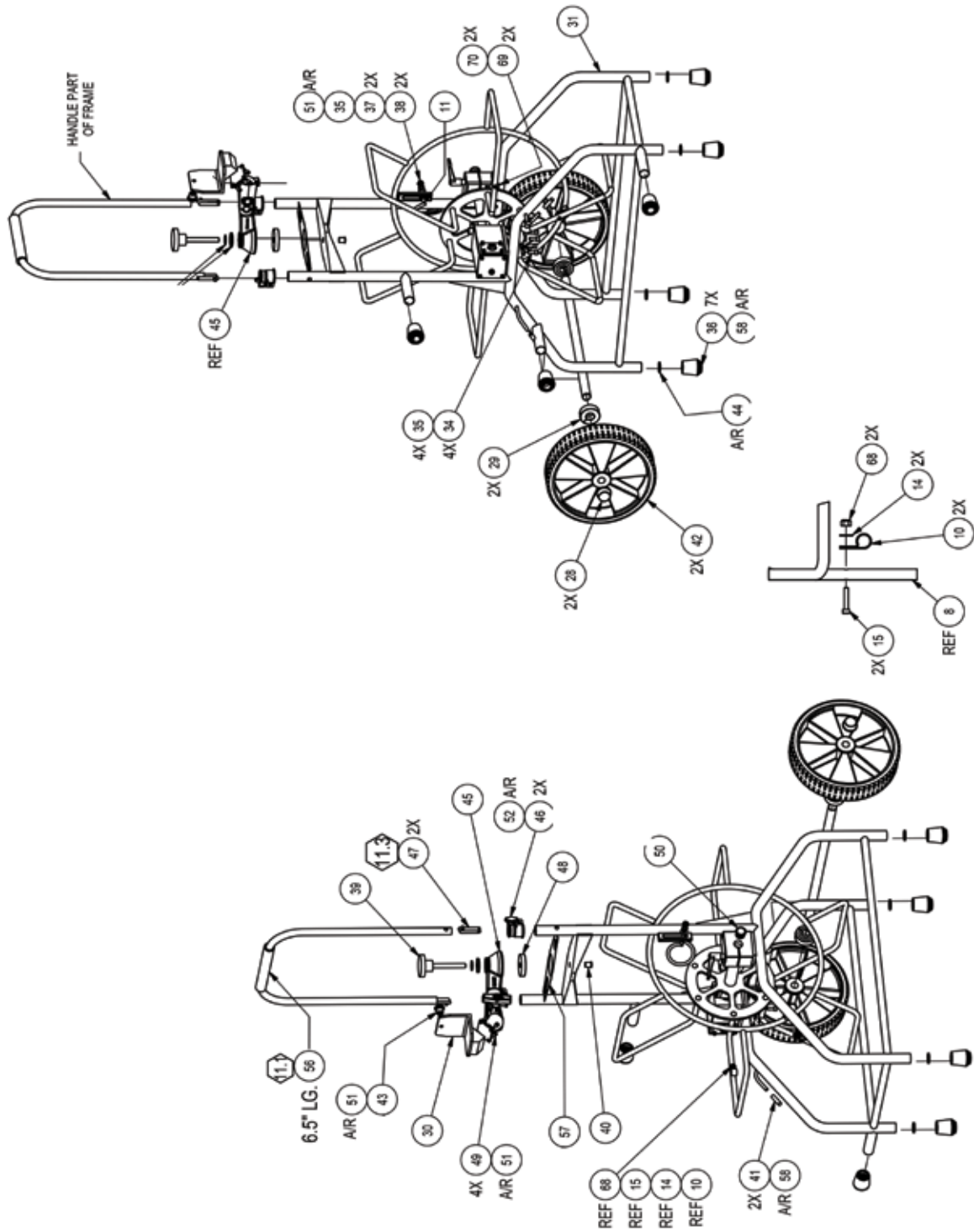

Figure 2b. Lateral Push System Coiler Assembly, CH300, Rev. H

| LATERAL PUSH SYSTEM COILER ASSEMBLY, MPLUS+, Rev. H, CH300 | | | |
|--|-------------------------------------|--------|-----|
| Item # | Description | P/N | Qty |
| 0001 | BEARING,BRAKE,BASKET ASSY | CH174 | 1 |
| 0002 | BEARING,SR&ENCODER,MPLUS+ | CH002 | 1 |
| 0003 | FLANGE,BEARING SR&ENCODER MPLUS+ | CH003 | 1 |
| 0004 | JACK SHFT,BEARING SR&ENCODER MPLUS+ | CH004 | 1 |
| 0005 | COVER,BEARING SR&ENCODER,MPLUS+ | CH005 | 1 |
| 0006 | HANDLE,ADJUSTBLE,BLK,NYL 5/16-18,SS | HW2907 | 1 |
| 0007 | SLIPRING,MOOG SRA-73540,2A,120V | EC1976 | 1 |
| 0008 | ASSY,BASKET WELDMENT,LAT MPLUS | CH011 | 1 |
| 0009 | SHAFT BUSHING,BASKET ASSY, MPLUS+ | CH014 | 1 |
| 0010 | CLAMP,TUBING INSULATED,1/2" | 121104 | 2 |
| 0011 | GUIDE,CABLE,RING, F/CH300 COILER | CH006 | 1 |
| 0012 | ENCODER,OPTICAL KIT,OEM | EC2054 | 1 |
| 0013 | CONNECTOR,BULKHD,FM,8PIN,LUMBERG | EC274 | 1 |
| 0014 | WASHER,FLAT,#8 SST | 100139 | 2 |
| 0015 | SCREW,CAP,SKT HD,8-32X7/8,SST | 103067 | 2 |
| 0016 | SCREW,CAP,SKT HD,6-32X3/8,SST | 105071 | 4 |
| 0017 | PLATE,MNTG,CONN EC2080 | CH037 | 1 |
| 0018 | SCREW,CAP,SKT HD,4-40X3/8,SST | 100054 | 3 |
| 0019 | O-RING,2-023,BUNA-N | HW731 | 1 |
| 0020 | SCREW,SHCS,8-32X3/8 SST | 100448 | 4 |
| 0021 | O-RING,2-035,BUNA | 7124 | 1 |
| 0022 | SCREW,CAP,SKT HD,6-32X1 1/2 SST | 100114 | 2 |
| 0023 | SEAL,OIL,1.00ID X 1.43 OD,VITON,SST | HW4039 | 2 |
| 0024 | PLATE,CONNECTOR MOUNT,MPLUS+ | CH063 | 1 |
| 0025 | O-RING,2-118 EP | 132208 | 1 |
| 0026 | SCREW,CAP,SKT HD,8-32X1/2,SST | 101025 | 4 |
| 0027 | CABLE ASSY,BASKET>SLPRING/ENCDR,MP+ | CH331 | 1 |
| 0028 | BLACK PUSHNUT FASTENER,3/4" SHAFT | HW2646 | 2 |
| 0029 | SHAFT COLLAR,ACETAL,.75 BORE X.50W | HW2882 | 2 |
| 0030 | MOUNTING BRACKET,COILER ASSY,MPLUS+ | CH019 | 1 |
| 0031 | FRAME ASSY,LATERAL PUSH SYS, MPLUS | CH302 | 1 |
| 0032 | TERMINAL,SOLDER LUG,LOCKWASHER #6 | HW2641 | 2 |
| 0033 | TUBE,SHRINK,BLACK 1/8" | 712789 | 1 |
| 0034 | SCREW,CAP,SKT HD,1/4-20X5/8,SST | 101024 | 4 |
| 0035 | WASHER,SPLIT LOCK,1/4" SST | 101740 | 5 |
| 0036 | WALKER TIP, .875 DIA, RUBBER, BLK | HW2971 | 7 |
| 0037 | WASHER,FLAT,1/4" SST | 101736 | 2 |

5

EXPLODED VIEW DRAWINGS & BOM'S

| LATERAL PUSH SYSTEM COILER ASSEMBLY, MPLUS+, Rev. H, CH300 | | | |
|--|-------------------------------------|--------|------|
| Item # | Description | P/N | Qty |
| 0038 | NUT,HEX,SST,1/4-20 | 101040 | 2 |
| 0039 | KNURLED KNOB,.375-16X3.0LG,303SST | HW2883 | 1 |
| 0040 | CAP,RIGID,PLASTIC, .375 THREAD | HW2506 | 1 |
| 0041 | CAP,ROUND,PUSH-ON,.25 OD,EDPM | HW2503 | 2 |
| 0042 | WHEEL,COILER ASSY,LATERAL PUSH SYS | CH010 | 2 |
| 0043 | PLUNGER,NYLON KNOB,.2 DIA X .2 LG | HW2434 | 1 |
| 0044 | WASHER,FLAT,5/16 USS PLD | 101132 | 7 |
| 0045 | SWIVEL MOUNT,1.5 BALL,RAM,SPECIAL | HW2501 | 1 |
| 0046 | LOCK,SPLIT COLLAR,7/8 TO 5/8-BSTYLE | CH097 | 2 |
| 0047 | SNAP BUTTON,SINGLE END, 0.25OD | HW4022 | 2 |
| 0048 | WASHER,2"ODX0.37 IDX.37 THK,BLK | HW2914 | 1 |
| 0049 | SCREW,CAP,SKT HD,10-32X3/8,SST | 103030 | 4 |
| 0050 | PLUG,HOLE F/3/4" HOLE | HW899 | 1 |
| 0051 | MRO-REMOVABLE LCK,ND 121200-2,BLUE | CS036 | 1 |
| 0052 | MRO-LOCTITE #411 INSTANT ADHESIVE | CS572 | 1 |
| 0053 | MRO-TIE,CABLE,3/32" X 4",BLACK | CS444 | 1 |
| 0054 | WIRE,#22AWG,BLACK,PVC,STRD | EC407 | 0.25 |
| 0055 | TUBE,SHRINK,BLACK 3/8"RNF | 712586 | 1 |
| 0056 | GRIP,FOAM TUBE,EPDM, .562ID,INCHES | CH098 | 6.5 |
| 0057 | DECAL, TOP SUPPORT PLATE, MPLUS+ | CH112 | 1 |
| 0058 | GLUE,GRIP,SCOTTS,4ML | CS597 | 1 |
| 0059 | MRO-ANTI-SEIZE,LPS NICKEL,P/N 03908 | CS407 | 1 |
| 0065 | MRO-GREASE,SUPERLUBE 21060 - 3 OZ | HW039 | 1 |
| 0066 | WASHER,SPLIT #6 SST | 100150 | 4 |
| 0067 | WASHER,SPLIT LOCK,#8 SST | 101738 | 4 |
| 0068 | NUT,LOCK NYLON INS,SST,8-32 | 112532 | 2 |
| 0069 | SCREW,CAP,SKT HD,1/4-20X1,SST | 101065 | 2 |
| 0070 | NUT,LOCK W/NYL INS 1/4-20 SST | HW030 | 2 |

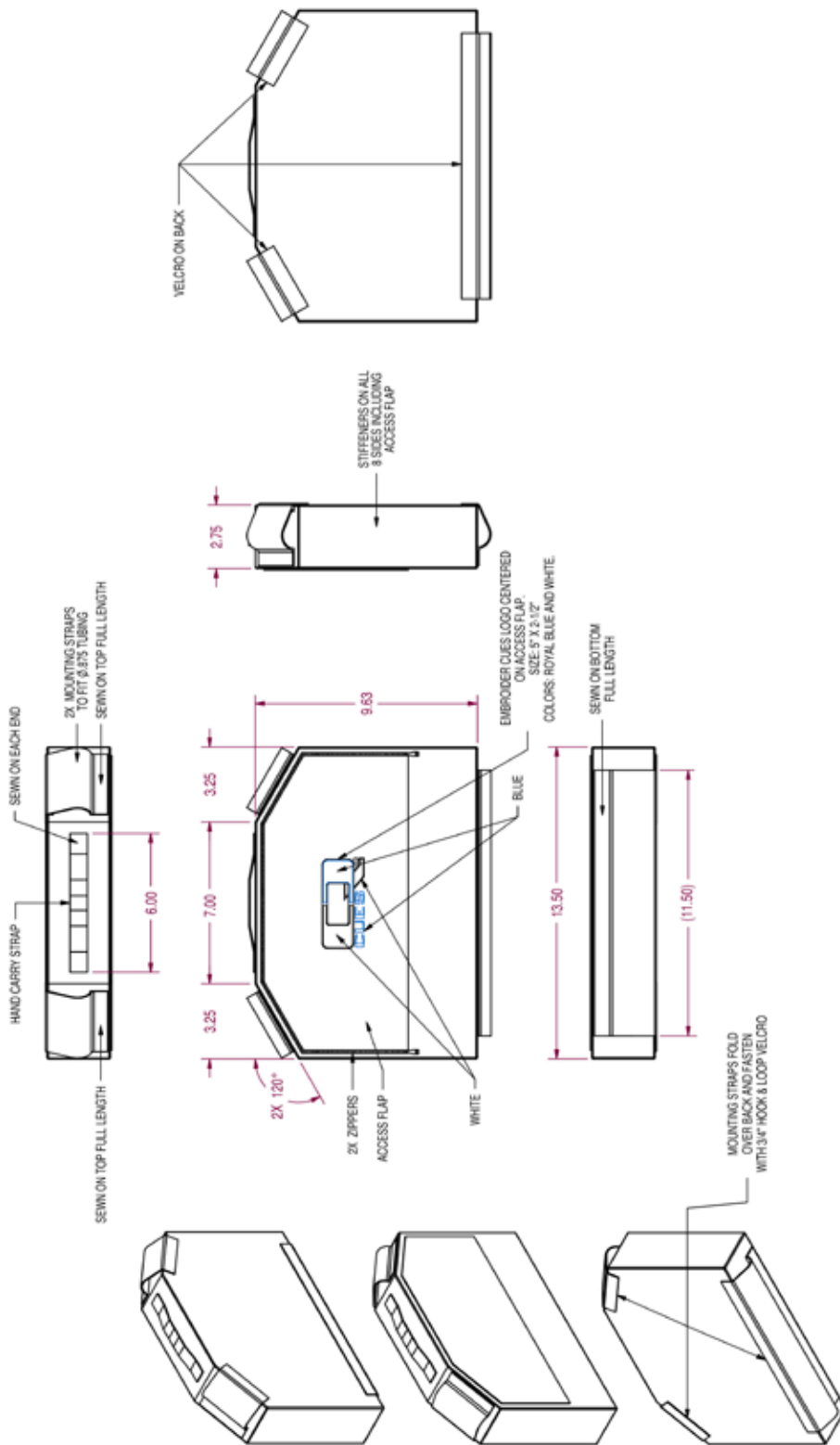

Figure 3. Lateral Push System Accessory Bag, CH061, Rev. -

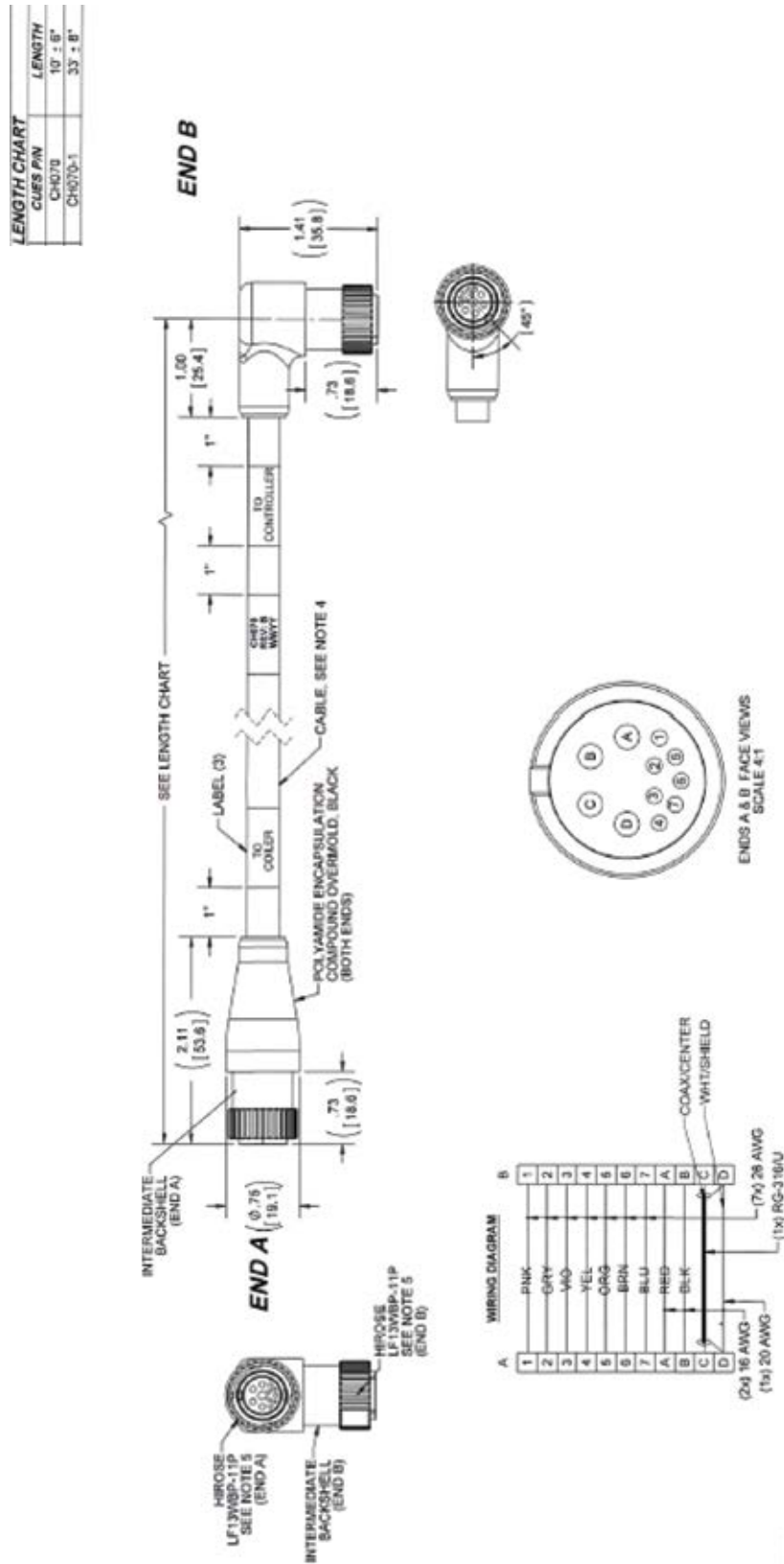

Figure 4. Cable Assembly, Controller>Coiler, 10', MPlus+, CH070, Rev. C

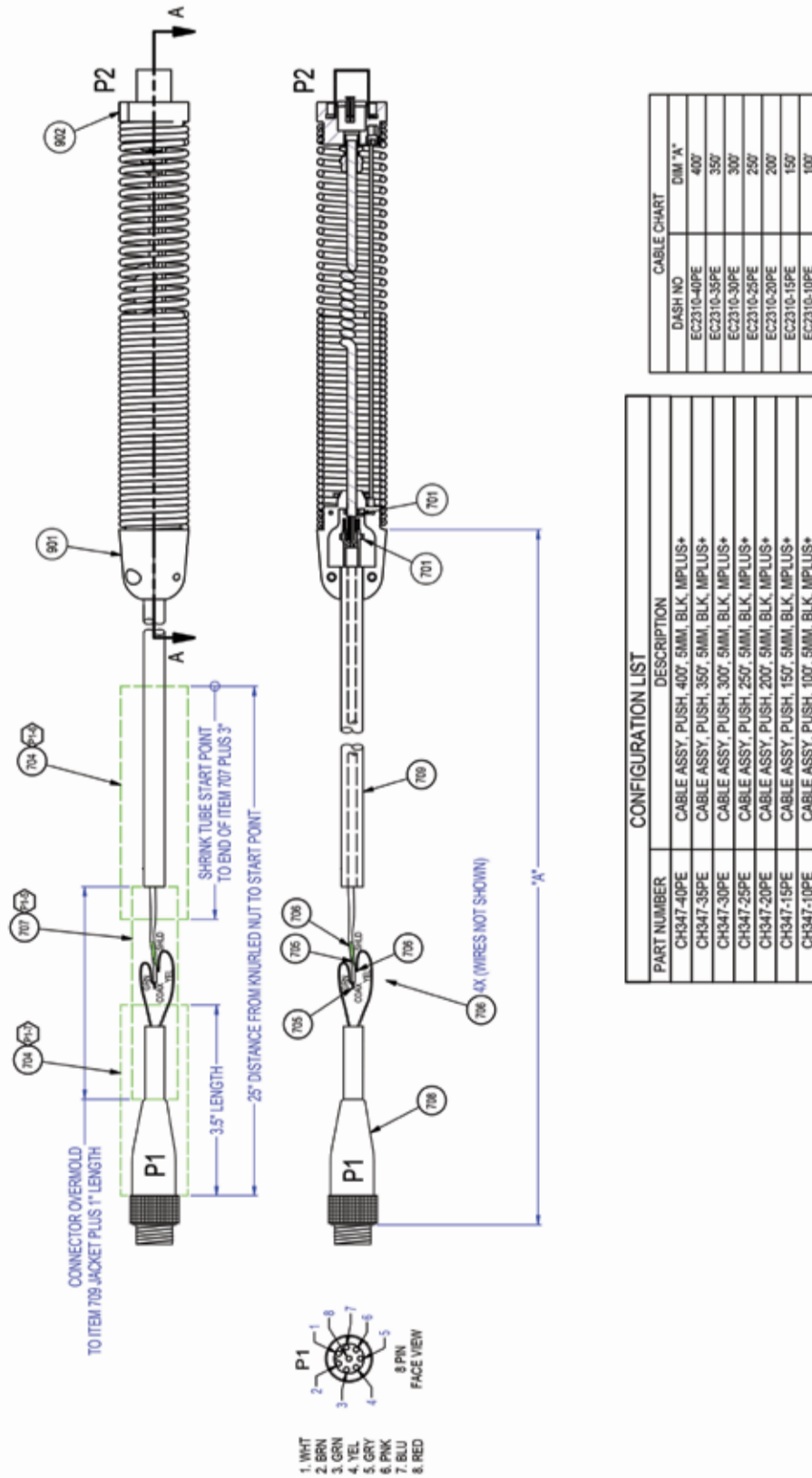

Figure 5. Push Cable Assembly 10PE-40PE, MPlus+, CH347, Rev. -



APPENDIX A

| LIST OF STATUS MESSAGES |
|------------------------------|
| ADDED CUSTOM CODE TO LIST |
| ATTEMPTING P&T RECONNECTION |
| ATTEMPTING uP&T RECONNECTION |
| BATTERY GAUGE OFF |
| BATTERY GAUGE ON |
| CAMERA HEAD SET TO P&T |
| CAMERA HEAD SET TO PS3 |
| CAMERA HEAD SET TO SR3 |
| CAMERA HEAD SET TO uP&T |
| CAMERA POWER FAULT: LOW V |
| CAMERA POWER FAULT: HIGH I |
| CAMERA POWER FAULT: HIGH V |
| CLIENT PAGE BACKGROUND OFF |
| CLIENT PAGE BACKGROUND ON |
| CODE CAN'T BE ALL SPACES |
| COILER SET TO AUX. REEL |
| COILER SET TO XL BASKET |
| COILER SET TO STD. BASKET |
| COUNT DIRECTION SET TO DOWN |
| COUNT DIRECTION SET TO UP |
| CUSTOM LIST IS EMPTY |
| DATE ONLY IN TOP LEFT |
| DATE ONLY IN TOP RIGHT |
| DELETED CUSTOM CODE |
| DISTANCE IN BOTTOM RIGHT |
| DISTANCE IN CENTER |
| DISTANCE IN TOP LEFT |
| DISTANCE IN TOP RIGHT |
| DISTANCE OFF |
| DVR NOT READY |
| FACTORY DEFAULTS NOT RESET |
| FREE FORM PAGE BACKGROND OFF |
| FREE FORM PAGE BACKGROND ON |
| FUNCTION UNAVAILABLE |
| GAUGE ON DUE TO LOW BATTERY |
| KEYBOARD POWER FAULT: HIGH I |
| LIGHTS POWER FAULT: LOW V |
| LIGHTS POWER FAULT: HIGH I |
| MINI PAN & TILT RECONNECTED |

| LIST OF STATUS MESSAGES |
|-------------------------------|
| NO MORE ROOM IN LIST |
| NO TRANSMITTER PRESENT |
| OBSERVATION CODES NOW CUES |
| OBSERVATION CODES NOW OTHER |
| OBSERVATION CODES NOW CUSTOM |
| OWNER PAGE BACKGROUND OFF |
| OWNER PAGE BACKGROUND ON |
| PAIRING UNSUCCESSFUL |
| PAN & TILT CAMERA REQUIRED |
| PRESS AGAIN TO ZERO DISTANCE |
| PRESS BUTTON AGAIN TO EDIT |
| PRESS <ENTER> TO SELECT CODE |
| SIMULTANEOUS P/T ENABLED |
| SIMULTANEOUS P/T DISABLED |
| SONDE FREQUENCY NOW 512 HZ |
| SONDE FREQUENCY NOW 8 KHZ |
| SONDE NOW OFF |
| SONDE NOW ON |
| TIME/DATE OFF |
| TIME/DATE IN TOP LEFT |
| TIME/DATE IN TOP RIGHT |
| UNHANDLED EXCEPTION PWR DOWN |
| UNITS SET TO U.S./IMPERIAL |
| UNITS SET TO METRIC |
| UNSUPPORTED USB DEVICE |
| uP&T CAMERA REQUIRED |
| uP&T RECONNECTED |
| USAGE TIME RESET (PWR CYCLE) |
| USB COMMUNICATION ERROR |
| USER PAGE BACKGROUND OFF |
| USER PAGE BACKGROUND ON |
| VIDEO FORMAT REMAINS NTSC |
| VIDEO FORMAT REMAINS PAL |
| WARNING: BATTERY OVERCURRENT |
| WARNING: INTERNAL +5VB ERROR |
| WVT START-UP : LAST PWR STATE |
| WVT START-UP : POWER OFF |
| WVT START-UP : POWER ON |
| WVT TYPE CHANGED |



APPENDIX A

STATUS MESSAGE DESCRIPTIONS:

Many of the messages displayed are self-explanatory. Here are some that may benefit from additional information:

ATTEMPTING P&T RECONNECTION:

Communication with the P&T camera has not been established. The firmware will continue to display this message every 5 seconds while it is not able to connect.

CODE CAN'T BE ALL SPACES:

When creating a custom code, there must be at least one non-space character in it.

CUSTOM LIST IS EMPTY:

This message is displayed when the operator attempts to view or delete a custom code list that is empty and after deleting the last entry from a custom list.

DVR NOT READY:

The internal DVR module requires 25 seconds to initialize after power-up. Attempting to adjust the microphone or speaker, or to display the DVR menu during this period will cause this message to be displayed.

FUNCTION NOT AVAILABLE:

Any time the operator tries to do something for which he doesn't have the proper equipment, e.g. move the Mini Pan & Tilt camera when he isn't using one, he will receive this message. It is also displayed when trying to toggle the DVR when on the GXP screen.

GAUGE ON DUE TO LOW BATTERY:

The battery gauge can only be turned off if the battery has more than 10% charge remaining.

NO MORE ROOM IN LIST:

Only 50 custom codes may be created. Attempting to add a custom code once there are already 50 codes will cause this message to be displayed.

CAMERA POWER FAULT: HIGH I:

If the current being drawn from camera power was measured at more than 0.45 amps, the camera power is shut down and this message will be displayed.

CAMERA POWER FAULT: HIGH V:

If the camera power voltage was measured at more than 31.02 Volts, the camera power supply is shut down and this message will be displayed.

LIGHTS POWER FAULT: HIGH I:

If the lights power being drawn was measured at more than 1.125 amps, the lights power supply is shut down and this message will be displayed.

LIGHTS POWER FAULT: HIGH V:

If the lights power voltage was measured at more than 31.02 Volts, the lights power supply is shut down and this message will be displayed.

UNHANDLED EXCEPTION PWR DOWN:

This message will only be displayed if the firmware has an unresolved error.

UNSUPPORTED USB DEVICE:

This message will be displayed if the firmware detects something other than the keyboard during normal operation, or a suitable thumb drive when performing a firmware update.

USB COMMUNICATION ERROR:

This message will be displayed if the firmware has difficulty communicating with a USB device.

WARNING: BATTERY OVERCURRENT:

If the battery current is measured at more than 8.0 A, this message will be displayed.

WARNING: INTERNAL +5VB ERROR:

If the internal CH412 board's '+5VB' supply is measured at more than 3% away from 5.0 Volts, this message will be displayed.

MPLUS+ FIELD FIRMWARE UPDATE

EQUIPMENT NEEDED:

1. Phillips screwdriver, size #1
2. USB Flash “thumb” drive (Specs: 2TB maximum capacity FAT(16) or FAT32 file system)

PROCEDURE:

1. Load the firmware update file, MPupdate.cfw, onto the USB Flash drive in the “root”, meaning not inside of any folder. For example, if the thumb drive shows up as drive E:, the update file should have the following path (address): E:\MPupdate.cfw. For USB Flash drives containing multiple partitions, the firmware update file must be loaded into the drive’s first primary partition, typically assigned the lowest letter alphabetically, i.e., closest to ‘A’, of the partitions on the drive.

To obtain the MPlus+ firmware update file, please contact CUES Customer Service at 1-800-327-7791.

2. Power-down the MPlus+, if necessary, by pressing the power button.
3. Using the Phillips screwdriver, unscrew the 14 screws that secure the keyboard panel to the fold-down portion of the MPlus+ Control Unit.



4. Locate the circuit board attached to the underside of the keyboard panel. Insert the USB Flash drive into the USB port, J4, on top of this circuit board.

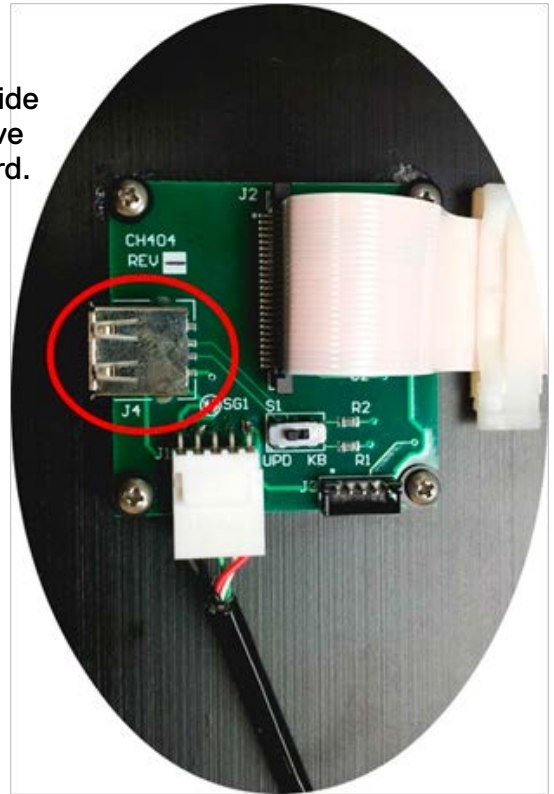

5. Move the sliding switch, S1, on the circuit board to the 'UPD' position.



MPLUS+ FIELD FIRMWARE UPDATE

6. Activate the firmware update mode:
 - Press and hold the MPlus+ power button. The system powers-up initially, as indicated by the blue LED turning on.
 - Continue holding down the MPlus+ power button until the system powers back down, as indicated by the blue LED turning off. This occurs after anywhere between three and six seconds.
 - Release the MPlus+ power button. The system immediately powers-up, but this time into the firmware update mode.
7. Wait while the MPlus+ firmware is updated. Onscreen messages indicate the update progress and will identify if any issues occur during programming.

Please refer to the Troubleshooting section if the system displays an error message.

8. Wait until the MPlus+ system automatically powers-down; this occurs approximately 8 – 10 seconds after the firmware update completes.
9. Remove the USB Flash drive from the circuit board.
10. Move the sliding switch, S1, on the circuit board back to the 'KB' position.



11. Set the keyboard panel back in place into the fold-down portion of the MPlus+ Control Unit, and, using the Phillips screwdriver, reinstall the 14 screws to secure it. Be careful to not over-tighten the screws.

TROUBLESHOOTING:

The following is a list of the error messages provided by the MPlus+ firmware update program, along with a description of what each indicates and some potential causes.

NOTES:

1. All of the below error messages can, additionally, be caused by communication problems with the attached USB Flash drive, which can be caused by poor connection between the contacts in the drive and those in the USB connector.
 2. If the error message description does not provide a solution, try pulling the USB Flash drive out and plugging it back in, and then retry the procedure from step 6.
 3. If failures persist, retry the procedure from the beginning with a different USB Flash drive.
- **NO USB DEVICE FOUND**
 - o A USB device is not plugged into the USB port, J4, on the circuit board attached to the underside of the keyboard panel.
 - **USB COMMUNICATION ERROR**
 - o The system is having unspecified problems communicating with the attached USB device.
 - **UNSUPPORTED CONFIG DSCRPTR**
 - o The 'Configuration Descriptor' data received from the USB device was too large to fit into the internal buffer.
 - o This is an uncommon error that should only occur when using a non-standard USB Flash drive or when the attached USB device is something else entirely.
 - **UNSUPPORTED USB DEVICE**
 - o The attached USB device has not been identified as a 'Mass Storage Device', which is the standard classification for USB Flash drives.
 - o Check the state of the slide switch, S1, on the circuit board attached to the underside of the keyboard panel. Make sure it is set to the 'UPD' position for performing the firmware update.
 - **UNSUPPORTED LOG BLOCK LEN**
 - o The 'Logical Block Length' reported by the USB Flash drive is not equal to the value, 512 bytes, supported by the MPlus+ firmware update program.
 - o This is an uncommon error that should only occur when using a non-standard USB Flash drive.
 - **UNSUPPORTED NUM LOG BLOCKS**
 - o The number of 'Logical Blocks' reported by the USB Flash drive exceeds the maximum number supported by the MPlus+ firmware update program.
 - o If the drive's 'Logical Block Length' is the standard 512 bytes, this equates to approximately 2TB of memory capacity.



MPLUS+ FIELD FIRMWARE UPDATE

TROUBLESHOOTING CONTINUED

- **UNSUPPORTED FILE SYSTEM**
 - The MPlus+ firmware update program was unable to locate a volume on the USB Flash drive formatted with either of the two supported file systems, FAT(16) or FAT32.
 - On USB Flash drives containing multiple partitions, only the first primary partition is examined.

- **UNSUPPORTED VOL SECTR SIZE**
 - The 'Bytes Per Sector' parameter of the detected FAT volume is not equal to the value, 512 bytes, supported by the MPlus+ firmware update program.
 - This is an uncommon error that should only occur when using a non-standard USB Flash drive.

- **VOLUME MAY BE CORRUPTED**
 - Information gathered from the FAT volume indicates that it may be corrupted.
 - This can result from either: (A) not dismounting the volume properly, e.g., pulling the USB Flash drive out of a USB port without first using the "Safely Remove..." feature, or (B) the occurrence of a disk read/write error, indicating that some of the USB Flash drive's memory sectors may have gone bad.

- **UPDATE FILE NOT FOUND**
 - The MPlus+ firmware update program was unable to locate a filename that matches the firmware update file, MPupdate.cfw, in the volume's "root" directory.
 - Check the filename of the firmware update file on the USB Flash drive to make sure it is named properly, including its three-letter extension. The filename is not case-sensitive.
 - Check the location of the firmware update file on the USB Flash drive to make sure it is located in the "root", i.e., not inside of any folder.

- **UPDATE FILE IS CORRUPTED**
 - The firmware update file that was found has failed one of the MPlus+ firmware update program's integrity checks, meaning it contains invalid data that cannot be used.
 - Try re-loading the firmware update file onto the USB Flash drive.
 - Try obtaining a fresh copy of the firmware update file, either by re-downloading the original file you received or by requesting a new copy from CUES Customer Service.

- **ERROR DURING PROGRAMMING**
 - Some of the raw firmware data being programmed into memory failed the verification step, i.e., the data read back differed from the data that was written.
 - This can result from a problem with the microcontroller on the main circuit board inside the MPlus+ Control Unit.

This page intentionally left blank.

CUES STANDARD 12 MONTH WARRANTY

CUES (“CUES”) warrants that all parts, components, and equipment manufactured by CUES shall be free from defects in material and workmanship under normal use and service for which it was intended for a period of twelve (12) months from the date of shipment of materials by CUES to the purchaser. CUES’ obligation under this warranty is limited, at CUES’ option, to replacing or repairing, free of charge, any defective materials returned, freight prepaid, to the CUES designated service facility. For all warranty claims, the materials must be returned in accordance with CUES Material Return Policy.

Major items of equipment, such as vehicles, generators, etc., furnished, but not manufactured by CUES, will be covered only under the warranty of the third party manufacturer of such equipment. Expendable parts, such as light bulbs, fuses, connectors, etc., are excluded from this warranty.

Purchaser must notify CUES of a breach of warranty not later than the last day of the warranty period; otherwise, such claims shall be deemed waived.

CUES does not warrant the materials to meet the requirements of the safety codes of any federal, state, municipal or other governmental or administrative jurisdiction. Purchaser assumes all risk and liability whatsoever resulting from the use of its products, whether used singly or in combination with other products, machines or equipment.

This Warranty shall not apply to any materials, or parts thereof, which have; (a) been repaired or altered by anyone other than CUES without CUES’ written consent; (b) been subject to misuse, abuse, negligence, accident, or damage; (c) not been installed or operated in accordance with CUES’ printed instructions, or; (d) been operated under conditions exceeding or more severe than those set forth in the specifications of design tolerance of the equipment.

THIS WARRANTY AND THE OBLIGATION AND LIABILITIES OF CUES HEREUNDER ARE EXCLUSIVE AND IN LIEU OF (AND PURCHASER HEREBY WAIVES) ALL OTHER WARRANTIES, GUARANTEES, REPRESENTATIONS, OBLIGATIONS, OR LIABILITIES, EXPRESSED OR IMPLIED, ARISING BY LAW OR OTHERWISE, INCLUDING ANY IMPLIED WARRANTY OF MERCHANTABILITY OR FITNESS FOR A PARTICULAR PURPOSE, REGARDLESS WHETHER OR NOT OCCASIONED BY CUES’ NEGLIGENCE.

CUES SHALL NOT BE LIABLE FOR ANY LOSS OR DAMAGE RESULTING, DIRECTLY OR INDIRECTLY, FROM THE USE OR LOSS OF USE OF THE MATERIALS, OR FOR SPECIAL, INDIRECT, OR CONSEQUENTIAL DAMAGES, ECONOMIC LOSSES, LOSS OF PROFITS, LOSS OF BUSINESS, OR LOSS OF BUSINESS OPPORTUNITY. Without limiting the generality of the foregoing, this exclusion from liability embraces Purchaser’s expenses for downtime or for making up downtime, damages to property, and injury to or death of any persons.

CUES neither assumes nor authorizes any person (including employees, agents, or representatives of CUES) to assume for it any other liability, guarantee, or warranty in connection with the sale or use of the materials, and no oral agreements, warranties, or understandings exist collateral to or affecting this warranty.

This warranty shall not be extended, altered, modified, or waived except by a written instrument signed by CUES.

SAFETY PRECAUTIONS

Precautions must always be taken when operating electronic equipment. Exposed wires, damaged equipment, or improper operation can lead to a dangerous situation.

Please take a few minutes and read this entire manual prior to operating the equipment. Follow all safety procedures and thoroughly inspect equipment prior to use each day. This will help the equipment retain its full value and will reduce the risk of injury, property, and/or equipment damage.



- Read the entire manual before attempting to connect or operate any equipment.
- Connect and disconnect cables only when the electric power is turned OFF.
- Never remove protection covers from the equipment or power generator. Internal repairs should only be done by an authorized CUES technician.
- If using a portable generator, always place it in an open area away from other equipment, manholes or obstructions prior to start-up; do not use a portable generator in an enclosed area.
- Upon receipt of the equipment, check for visible damage. If there is any evidence of rough handling, if damage is found, or if any equipment is missing, please contact the CUES Customer Service at 1-800-327-7791.

PERSONAL SAFETY EQUIPMENT & TRAINING

CUES stresses the use of appropriate safety equipment while working in and around manholes and during system operation. Safety should constantly remain the utmost priority. NOTE: The user of CUES products is responsible for all training and operation under federal, state and local guidelines and regulations for both confined space entry and traffic control. Recommended safety equipment includes but is not limited to the following:

- Safety goggles
- Work gloves
- Steel-toed boots
- Reflective vests
- Hard hats
- Filter masks (full respirators may be necessary)
- Flashlights
- Safety lines
- Traffic warning signs
- Traffic cones
- Gas detectors
- Ventilation fans

CUES @ makes no warranty for the use of its products and assumes no responsibility for any errors or omissions in this document or for incidental or consequential damages resulting from misuse of the products.

CUES MATERIAL RETURN POLICY

To ensure the orderly return of CUES products from our customers and to assure proper credit and warranty replacements handled in a timely manner, CUES has implemented a MATERIAL RETURN AUTHORIZATION (MRA) SYSTEM. Please read and follow the instructions below to ensure your MRA is handled properly and efficiently:

1. Once it is determined that a CUES product needs to be returned, call the CUES Parts Department in Orlando at 1-800-327-7791.
2. CUES will provide an MRA number by phone and ask a few questions.
3. CUES will then mail or fax the MATERIAL RETURN AUTHORIZATION (MRA) FORM with the MRA number, or include it with the replacement parts, if applicable.
4. Follow all instructions on the MRA Form. Make 2 copies - one for your records and the other will be used as a packing list.
5. Place an MRA sheet in with the parts that are shipped back to CUES along with a copy of the original packing slip or invoice, if possible. Send only the parts originally agreed upon with your Parts Representative. Any deviations/changes will require an additional MRA.
6. Make sure to include a copy of the MRA form for a packing slip.
7. Write the MRA number on the outside of the box.
8. Please take care in packing the parts that are to be shipped back to CUES. Parts must be individually protected from each other and appropriate packing material must be used to prevent damage during shipping.
9. Freight on the material returned is to be prepaid by the customer. Depending on the warranty determination, CUES, at its' option, may credit freight charges both ways.
10. The parts must be returned to CUES within 5 days of receipt of the MRA for credit to be granted.

Under normal circumstances, a warranty determination can be made within 30 days, and if under warranty, the part will be replaced at no charge. A credit will be issued if you have already received a replacement part. No credits will be issued until CUES receives the defective part.

*****NOTE*****

CUES will not warrant look-alike parts sold by competitors and reserves the right to charge a restocking fee. CUES shall not be liable for any loss or damage resulting, directly or indirectly, from the use of the materials, or for special, indirect, or consequential damages, economic losses, loss of profits, loss of business, or loss of business opportunity.

Without limiting the generality of the foregoing, this exclusion from liability embraces purchaser's expenses for downtime or for making up downtime, damages to property, and injury to or death of any persons.

CUES neither assumes nor authorizes any person (including employees, agents, or representatives of CUES) to assume for it any other liability, guarantee, or warranty in connection with the sale or use of the materials, and no oral agreements, warranties, or understandings exist collateral to or affecting this warranty. This warranty shall not be extended, altered, modified, or waived except by a written instrument signed by an authorized CUES representative.

CUES MATERIAL RETURN AUTHORIZATION

| | | | |
|--------------------|----------|----------------------|----------------------|
| Cust #: | Name: | Contact: | Date: 4/21/2004 |
| Original SO #: N/A | SO Orig: | Dated: | New SO #: |
| Return For: | Reason: | Territory | S.O. To Be Credited: |
| | | Prod. Ref. Cd: 51200 | Orig: |
| Explanation: | | | |
| | | | |

| Items Returned | |
|----------------|--|
| 1 | |
| 2 | |
| 3 | |
| 4 | |
| 5 | |
| 6 | |

To ensure your MRA is handled properly and efficiently, please follow the instructions below.

1. Ship parts back within five (5) business days of receiving your MRA number. Parts ordered in error are subject to a restocking fee.
2. Send only the parts originally agreed upon with your customer service representative. Any deviations will require an additional MRA.
3. Make a copy of this sheet and keep the original for your records. Use the copy as a packing slip.
4. Write the MRA number on the outside of the box.
5. Parts must be individually protected from each other (original packaging would be best) and appropriate packing material must be used to prevent against damage during shipping.

Note: If parts are not well protected and arrive at our facility damaged in any manner, we will automatically reject them and return them to you without credit.

PARTS WILL BE RETURNED TO CUSTOMER AT CUSTOMER EXPENSE WITHOUT AN MRA NUMBER DOCUMENTED ON BOX. CUES IS NOT RESPONSIBLE FOR SHIPMENT FROM CUSTOMER TO CUES.

Use this section as a Packing Slip.

Please remember to write the MRA number on the box.

| |
|-----------------------|
| MRA #: XXXX |
|-----------------------|

Return To:

Cues
 3600 Rio Vista Avenue
 Orlando, Fl. 32805
 (407) 849-0190
 FAX (407) 425-1569
 WATS 800-327-7791

CUES PARTS & SERVICE

At CUES, we realize your return on investment is directly related to daily production in the field. By stocking the largest inventory of OEM equipment in our industry, CUES strives to ship all parts orders on the same day or within 24 hours after receipt of the order.

Whether you need a camera or a fuse, CUES will quickly process and ship your order in accordance with your schedule requirements! Our experienced parts professionals can help you with parts identification, shipping methods, equipment operation questions, and connect you to the correct specialist for troubleshooting!

CUES offers four convenient stocking locations that contain a large assortment of parts, finished products, portable, and truck mounted systems. Texas, Arizona, Oklahoma and Louisiana customers can be serviced by our local dealerships. Contact us at your most convenient stocking location! For authorized dealer locations, log onto our website at www.cuesinc.com.

Parts can be ordered via phone or facsimile! For operating hours, contact information, and locations, log onto our website at www.cuesinc.com. Contact us at your most convenient stocking location! Log onto our website at www.cuesinc.com to view the CUES Parts Department & Dealers hours & locations.

CUES Parts Department: Parts turnaround is normally within 24 hours after receipt of order. Please note that special shipping arrangements can be made at the time of the order. All return shipments received at CUES freight collect will be refused upon delivery unless previously authorized by CUES personnel. Normal operating hours are 8am to 5pm, EST., Phone: 800-327-7791, Fax: 800-831-1184.

CUES Service Depot: Service turnaround is normally 72 hours or less upon receipt at our depot, excluding weekends and holidays. All return shipments received at CUES freight collect will be refused upon delivery unless previously authorized by CUES personnel. Normal operating hours are 8am to 5pm, EST., Phone: 800-327-7791.

CUES ® Corporate Office
3600 Rio Vista Avenue
Orlando, Florida 32805
800-327-7791
407-425-1569 FAX

8am - 6pm EST M-Fri

CUES ® Atlanta
3755 Industrial Ct.
NW, Suite 14
Suwanee, GA 30024
770-945-8674
770-945-9604 FAX

8am - 5pm EST M-Fri

CUES West
1943 S. Augusta Ct.
Ontario, CA 91761
909-923-2001
909-923-2091 FAX

7^{AM} - 6^{PM} PST M-Fri

CUES ® Northern California
640 Eubanks Court, Suite C
Vacaville, CA 95688
Phone: 866-358-CUES
Fax: 707-449-0260

8:00^{AM} - 5^{PM} PST M-Fri

CUES ® MidWest
2325 Parklawn Drive, Suite K
Waukesha, WI 53186
Phone:: 262-717-3165
Fax: 262-717-3167

7AM - 4PM CST M-Fri

CUES ® Canada
1675 Sismet Rd., #2
Mississauga, Ontario
Canada L4W 1P9
905-238-9178
905-238-5018 FAX

8^{AM} - 5^{PM} EST M-Fri

CUES Northwest
1000 NW Commerce Ct., Suite B
Estacada, OR 97023
Phone: 1.800.432.1549 ext: 403
Fax: 909-923-2051

This Record of Revision page is designed to allow the manual user to determine the Engineering/ Manufacturing level to which the manual is written. As engineering changes to the hardware and/or software are made at CUES, necessary information in the manual will be revised to reflect those changes. The latest change level and the rationale for any change(s) will be explained in tabular format on this page to allow the manual user to be better equipped should the need arise to call CUES regarding technical information.

| ORIGINAL MANUAL | REVISION | CHANGE DESCRIPTION |
|-----------------|----------|---|
| MPlus+ | 040414 | Initial preliminary release |
| | 042214 | Added instructions for SDHC MEMORY CARD WITH EMBEDDED WIRELESS LAN FUNCTIONALITY |
| | 053014 | Revised STANDARD and OPTIONAL equipment lists |
| | 081114 | Updated various SYSTEM MENU instructions to current. |
| | 090214 | R02 firmware released, which caused numerous changes throughout the manual. |
| | 030215 | R03 & R04 firmware released, which caused numerous changes throughout the manual. |
| | 121515 | <ul style="list-style-type: none"> • Added Appendix B - Field Firmware Update Instructions • Added MPlus+ XL version information throughout • Added BOM and drawings • Numerous other changes |
| | 011917 | Updated the manual to current Rev. 07 |
| | 111417 | Updated the manual to include the new Sensoray DVR instructions. |
| | 011518 | Removed the new Sensoray DVR instructions and added a note to refer to the DVR-USB Operating Appendix, P/N EC2978-APP, (located at the back of this manual) for operating instructions. |
| | 091020 | Various updates throughout the manual; updated available BOMs and drawings. |
| | 020921 | Updated the Optional Equipment Table on page 5. |
| | 12.2024 | Updated the manual per ECR #123691 |

Innovation for over

5
Years

CUES is the world's leading manufacturer of closed circuit television video (CCTV) inspection, rehabilitation, pipe profiling equipment and asset inspection/decision support software. For over 50 years, **CUES** has provided innovative pipeline inspection technology and solutions to enable accurate condition assessment and proactive maintenance programs for buried infrastructure.

In addition to inspection equipment, **CUES** also designs, manufactures, and sells a broad range of pipeline rehabilitation and profiling equipment. These include chemical grouting systems for sewer line pipe joints capable of using a wide variety of grouting products. **CUES** also manufactures lateral reinstatement cutting systems which enable the reinstating of laterals in mainline sewers after they have been relined with any of a wide variety of liner materials. Pipe profiling is accomplished via Laser for Sonar based systems.

CUES has the most locations and dealers available to serve you! To find a local **CUES** facility, find the operating hours for a particular location, or to contact us at your most convenient stocking location, please log onto our website at www.cuesinc.com or call the **CUES** Corporate Headquarters in Orlando, Florida for more information.