



# flexitrac™ C550c

CUES's advanced, crawler-based digital video inspection system

Operation Manual

[C550c-OPMAN-ENG/05]

Rev 05

March 2020



# Preface

## Before you begin

Please read this operation manual before using the C550c system.

The C550c system is a modular system that can be purchased as a full system package or as individual components. Contact your CUES representative to ensure you are purchasing the appropriate product for your needs.

The contents of this manual are subject to change. CUES products are under continuous development. CUES reserves the right to modify any product, including this manual, without notice and some product changes may have taken place after publication of this manual.

For the latest information about the flexiprobe product family, including all accessories, documentation and software updates, contact your local CUES dealer or visit [www.cuesinc.com](http://www.cuesinc.com).

## **Copyright © 2020 CUES Ltd. All rights reserved.**

CUES is a subsidiary of SPX Corporation.

### **Trademarks**

CUES and Accupoint are considered trademarks of Cues Inc. Radiodetection, flexiprobe, flexitrax, and flexicoiler are considered trademarks of Radiodetection Ltd. Radiodetection Ltd is a subsidiary of SPX Corporation. Due to a policy of continued development, we reserve the right to alter or amend any published specification without notice. This document may not be copied, reproduced, transmitted, modified or used, in whole or in part, without the prior written consent of CUES Inc.

Other trademarks or registered trademarks mentioned in this document belong to their respective owners.

### **Disclaimer**

Any third-party products (including hardware, software and services) mentioned in this manual are for instructional purposes only and are not an endorsement by CUES Inc or SPX Corporation.

CUES Inc does not accept any liability for loss of data or damage to equipment when using any third-party products.

# Compliance

## EU Compliance

This equipment complies with the following EU Directives:

- EMC Directive: 2014/30/EU
- EMF Directive: 2013/35/EU
- Low Voltage Directive: 2014/35/EU
- RoHS Directive: 2011/65/EU
- WEEE Directive: 2012/19/EU

## Industry Canada Compliance

ICES-003 Class A Notice:

This Class A digital apparatus complies with Canadian ICES-003.

Avis NMB-003, Classe A:

Cet appareil numérique de la classe A est conforme à la norme NMB-003 du Canada

## Ingress Protection Marking

This system complies with this rating for IEC standard 60529, solid particle and liquid ingress protection:

- IP55: Controller covers and connection panels open or closed.



## **FCC 15 Compliance**

This equipment complies with Part 15 of the FCC Rules. Operation is subject to the following two conditions:

- The equipment may not cause harmful interference.
- The equipment must accept any interference received, including interference that may cause undesired operation.

This equipment has been tested and found to comply with the limits for a Class A digital device pursuant to Part 15 of the FCC Rules. These limits are designed to provide reasonable protection against harmful interference when the equipment is operated in a commercial environment. This equipment generates, uses, and can radiate radio frequency energy and, if not installed and used in accordance with the manufacturer's instruction manual, may cause harmful interference with radio communications. Operation of this equipment in a residential area is likely to cause harmful interference, in which case you will be required to correct the interference at your own expense.

Any modifications made to this equipment not approved by CUES may void the authority granted to the user by the FCC to operate this equipment.

## Warnings, Cautions and Notes

Please observe all warnings, cautions and notes in this manual before operating any CUES product.

**Warning!** *Warnings alert you to possible personal injury.*

**Caution:** *Cautions alert you to possible equipment damage.*

**Note:** *Notes contain useful information.*

### Warning symbols



**General Warning:** Refer to the manual for specific instruction or advice.



**Electrical Hazard:** Observe safe practices and exercise extreme caution.



**Biohazard:** Disinfect after use. Wear appropriate personal protective equipment (PPE).



**Hot Surface:** Allow to cool or use appropriate protection when handling.



**Heavy object:** Take additional care when lifting.

## Perform a risk assessment



**Warning:** *Always carry out a risk assessment of the site to be inspected. This equipment is NOT approved for use in areas where potentially explosive (or otherwise hazardous) gases, vapors, liquids or solids may be present.*

CUES has taken care to provide the necessary information in this manual for the safe installation, operation, maintenance and disposal of this equipment. However, you must carry out a risk assessment before starting work as it may identify other safety issues.

Always follow standard safety precautions for working in hostile environments, including precautions for manual handling, biological hazards and personal injury.

The C550c PSU has a number of ventilation slots around the casing that are designed to maximize air circulation and reduce heat. There is a potential fire risk if the build-up of heat is prevented from escaping. Under no circumstances are these ventilation slots to be covered or blocked.



**Warning:** *Use the camera distance counter as an estimation only. CUES recommends that you use a sonde and CUES cable locator to accurately locate positions of interest, especially before starting construction works.*

## Safety precautions

### Electrical precautions



**Warning:** *If the system connects to mains operated equipment, the external equipment must be earthed in accordance with the manufacturer's instructions. Failure to comply with this may cause the system to become live and a **lethal hazard**.*



**Warning:** *System components must **not** be connected or disconnected when the power is on. Do not touch any connectors while the system is live*



**Warning! Always remove the fuse when the controller is transported by air!**

Always ensure that cabling is properly connected.

Always switch the system on and off using the controller power button and the on/off switch on the Power Supply Unit (PSU). The PSU is integrated within the Powered Drum (see [page 37](#)) and separate from the Manual Drum (see [page 38](#)).

Make sure that video and power cables are not entangled in the drum or reel. Cable ties are recommended and will not impede system performance.



The C550c system requires a connection to a protective earth; if in doubt, consult a qualified electrician. Electrical equipment is factory-tested for electrical safety. Routine inspection is recommended (and may be required by law) to maintain this level of protection. If you are unsure, contact your local safety authority for advice.

## Electrical precautions (continued)



The external connectors of the C550c Manual PSU unit and Powered Drum are required to be properly sealed by the blanking caps provided or by using the correct leads to prevent water damage to the units. Under no circumstances are these connectors to be left un-blanked.

Take care to ensure that video and power cables do not get entangled in the drum. Cable ties are recommended and will not impede system performance. Always store the flexitrax C550c system in a clean and dry environment.



If using a generator follow the manufacturer's instructions on load connection and sequencing. In the absence of these instructions the following guidelines should be used:

- When starting the generator; ensure that all electrical loads, including the flexitrax C550c are switched off before starting the generator. Allow the generator to stabilize before connecting any electrical loads or switching on the flexitrax C550c.
- When stopping the generator; ensure all electrical loads, including the flexitrax C550c are switched off before stopping the generator.
- Starting or stopping a generator whilst the flexitrax C550c system is connected and the main switch is in the On position could lead to damage to the flexitrax C550c system or the generator.

## Electrical precautions (continued)



If using an inverter to power the system, a good quality full sine-wave model should be selected. Quasi-sine wave inverters are not recommended for use with this product.

Please observe your company, region and country's Standard Code of Practice for surveying underground utilities with CCTV equipment when using this equipment.

## Biological precautions



**Warning:** *Foul systems can be a source of serious biological hazards. Wear appropriate personal protective equipment (PPE) when handling the C550c.*

Always use heavy-duty industrial gloves when withdrawing a rod from a sewer.

## Battery precautions

The controller contains a Li-Ion rechargeable battery. Only use charging equipment provided by CUES. The use of alternative chargers may cause a safety hazard and/or reduce the life of the battery.

The battery is designed to protect itself against over-discharge, overcharge and short circuit between charge terminals. Other batteries may not provide these safety circuits.



**Warning:** *Exposing the controller's Li-Ion battery to high temperatures (over 140°F or 60°C) may activate safety systems and cause a permanent battery failure.*

**Caution:** *Do not tamper with, or attempt to disassemble, the battery.*

**Caution:** *If battery failure is suspected, return the entire system to an authorized repair center for investigation and repair. Local, national or IATA transport regulations may restrict the shipment of faulty batteries. Check with your courier for restrictions and best practice guidelines. Talk to a CUES sales representative for authorized repair centers.*

**Caution:** *Waste Li-Ion batteries must be disposed of properly, use an approved recycling facility for electronic waste.*

### Camera precautions



**Warning:** *The camera will get hot with use. This is normal. To avoid risk of burns, do not touch the camera when it is switched on or immediately after switching it off. Leave time for it to cool before handling. Exercise care when handling the camera; consider using gloves.*



**Warning:** *The camera LEDs are very powerful. Do not look directly at the LEDs or point them at other people.*

### Pushrod reel precautions



**Warning:** *A coiled rod retains a large amount of energy when coiled and can cause injury if not correctly handled. Only competent personnel should handle this product.*

CUES and CUES recommend that a risk assessment is undertaken before the rod is handled, the bindings are cut or when using, loading, unloading, uncoiling or coiling rod.

CUES and CUES accept no liability for injury or damage to equipment incurred whilst using, loading, unloading, uncoiling or coiling the rod.

### Moving or transporting the system



**Warning:** *Some components of the C550c system are heavy. If available, use the wheels to assist transport. Observe heavy-lifting safety practices when lifting any component of this system. For the system weight and dimensions, see the specifications on [page 263](#).*



**Warning!** *Never lower crawlers or other heavy equipment into manholes while personnel work in the manhole.*



**Warning!** Always *remove the fuse when the controller is transported by air!*

### Disposal

Do not dispose of this product in municipal waste facilities. Please check local regulations for disposal of electronic products, batteries and hazardous waste.

C550c complies with the requirements of 2012/19/EU Waste Electrical and Electronic Equipment.



# Contents

flexitrax™ C550c Operation Manual .....	1	1.3 Safety notices.....	22
Preface.....	2	1.4 Training .....	23
Before you begin.....	2	1.5 Updates and latest information .....	23
Copyright © 2019 CUES Ltd. All rights reserved.....	3	1.6 CUES technical support.....	23
Compliance.....	4	2 Quick Start.....	24
Warnings, Cautions and Notes.....	6	3 System overview.....	26
Perform a risk assessment.....	7	3.1 Controller.....	26
Safety precautions .....	8	3.1.1 Controller front view .....	27
Disposal.....	12	3.1.2 Controller rear view .....	29
Contents.....	13	3.1.3 Handle-mounted status indicators ..	30
1 Introduction .....	20	3.1.4 Main connection panel .....	31
1.1 C550c features.....	21	3.1.5 Auxiliary connection panel.....	32
1.2 Definitions.....	22	3.1.6 Panel buttons .....	33
		3.2 Controller home screen .....	34
		3.3 Controller battery .....	36
		3.3.1 Battery care.....	36
		3.3.2 Temperature .....	36
		3.3.3 Battery life .....	37

3.4 Cable drums.....	37	4.4 Controller.....	73
3.4.1 Powered drum .....	38	4.4.1 Mounting on the drum .....	73
3.4.2 Manual drum and PSU.....	40	4.4.2 Power.....	73
3.4.3 Crawlers and Cameras .....	42	4.4.3 Internal storage .....	73
3.5 Pushrod reels.....	44	4.4.4 USB memory stick.....	74
3.5.1 Reels .....	44	4.4.5 Keyboard .....	74
3.5.2 Reel features .....	45	4.4.6 Headset .....	75
3.5.3 Cameras.....	46	4.5 Pushrod reels .....	76
3.5.4 Flexi and sondes.....	47	4.6 Cameras and accessories .....	78
3.5.5 Skids.....	48	4.6.1 Camera .....	78
4 System assembly .....	49	4.6.2 Sondes.....	81
4.1 Crawler, Camera and accessories .....	49	4.6.3 Universal flexi.....	82
4.1.1 Crawler weight (P354 Only).....	51	4.6.4 Skids.....	83
4.1.2 Wheels and tires.....	51	4.6.5 W-Skids .....	87
4.1.3 Cameras.....	58	4.7 Battery.....	87
4.1.4 Elevators .....	60	4.7.1 Charge the battery before using	
4.1.5 Crawler connection.....	67	the controller .....	89
4.1.6 Crawler deployment tools .....	69	4.7.2 If the battery has low charge .....	90
4.2 Drums & External PSU.....	69	4.7.3 Power the controller from a vehicle	91
4.3 Command module.....	70	4.7.4 How long does it take to recharge	
		the battery from my vehicle?.....	91

4.7.5 Replacing the battery .....	92	5.7 Import a company logo .....	128
5 System setup .....	93	5.8 Set up a video title page .....	129
5.1 Insert the fuse .....	93	5.8.1 Can I set a custom title page? .....	130
5.2 Power on the controller .....	94	5.8.2 Design the video title page .....	131
5.3 Setup wizard: Set controller preferences and company details .....	95	5.8.3 Enable the video title page .....	133
5.4 Calibrate the equipment .....	99	6 Operating the system .....	135
5.5 Status icons .....	100	6.1 Before you begin .....	135
5.6 Configure the system settings .....	101	6.2 Confirming the system equipment .....	136
5.6.1 Using the Settings menus .....	102	6.3 Emergency stop .....	137
5.6.2 Controller settings .....	104	6.4 Crawler Deployment .....	137
5.6.3 Screen overlay settings .....	106	6.4.1 Before deployment .....	138
5.6.4 Equipment settings .....	110	6.4.2 Using the crawler deployment tool .....	139
5.6.5 Reporting settings .....	111	6.4.3 Set-Up .....	140
5.6.6 Network settings .....	113	6.4.4 Strap hook setup .....	141
5.6.7 Email settings .....	120	6.4.5 Poles .....	144
5.6.8 Dropbox Settings .....	121	6.4.6 Using the deployment tool .....	144
5.6.9 Maintenance .....	124	6.4.7 Cable deployment rollers .....	146
5.6.10 Company details .....	127	6.4.8 Distance counter and stop point ...	147
		6.4.9 Sonde .....	148

6.5 System stop .....	149	6.11.1 Connecting to a nearby connected device.....	172
6.6 Driving the crawlers.....	150	6.12 Record a video .....	175
6.6.1 AUTO and manual modes .....	151	6.12.1 Video format and size.....	175
6.6.2 Steering (P356 crawler only).....	156	6.12.2 About the panel buttons .....	176
6.6.3 Analog joystick control .....	157	6.12.3 On-screen recording indicators ..	177
6.6.4 Topple warning .....	157	6.12.4 Quickly record a new video .....	178
6.6.5 Powered elevator control .....	158	6.12.5 Set up a new survey and record a new video .....	179
6.7 Camera control (lights, focus, pan, rotate, zoom).....	160	6.12.6 Record a further video for the survey currently open .....	181
6.7.1 Analog joystick control .....	161	6.13 Video tools.....	182
6.7.2 Camera focus control.....	161	6.13.1 Pause, resume and stop recording .....	182
6.7.3 Camera zoom control .....	162	6.13.2 Rotate the video feed .....	183
6.7.4 Camera iris control.....	162	6.13.3 Take a photo .....	183
6.7.5 Lighting control .....	162	6.13.4 Add overlay text and shapes to video segments .....	184
6.7.6 Camera position control modes ....	163	6.13.5 Record an audio commentary ....	187
6.7.7 Joint scan .....	164	6.13.6 Listen to an audio commentary ..	188
6.8 Pushrod reels.....	166	6.13.7 Use a sonde.....	188
6.9 Deploy pushrods .....	169		
6.10 Zero the camera distance.....	170		
6.11 Streaming images to a nearby device .	172		

6.14	Replay a video .....	189	7.4.3	Connect to the internet.....	207
6.14.1	Fast forward and rewind .....	190	7.4.4	Switch to a different WiFi network	208
6.14.2	Adjust the playback volume .....	190	7.4.5	Select surveys for export.....	209
6.15	Take a photo directly .....	191	7.4.6	Export to USB .....	210
6.16	Turn off the camera.....	194	7.4.7	Export as email attachments .....	211
6.17	Retrieve the crawler .....	195	7.4.8	Email send failure.....	212
7	Surveys .....	196	7.4.9	Manage email recipients .....	217
7.1	Create a new survey .....	196	7.4.10	Export to Dropbox .....	219
7.2	Edit survey screen.....	199	7.4.11	Where is my survey in Dropbox?	221
7.3	Manage existing surveys.....	200	7.5	Observations .....	222
7.3.1	Open a survey .....	201	7.5.1	Condition codes .....	223
7.3.2	Search for a survey.....	201	7.5.2	Add an observation .....	224
7.3.3	Sort surveys by title or date .....	202	7.5.3	Jump to observations when playing back a video.....	226
7.3.4	Delete surveys.....	202	7.5.4	View or edit an observation .....	227
7.3.5	Rename a survey.....	203	7.5.5	Delete observations .....	228
7.3.6	Edit the survey header details.....	204	7.5.6	Clock references .....	230
7.4	Export a survey .....	205	7.6	Reports.....	231
7.4.1	What is exported?.....	205	7.6.1	Drain and sewer diagrams .....	232
7.4.2	Export options.....	206	7.6.2	Manhole and inspection chamber diagrams .....	233

7.7 Video streaming .....	234	11 Software updates .....	261
7.8 Menu shortcuts .....	236	12 Specifications.....	263
7.9 Supported survey standards .....	237	12.1 Controller specifications.....	263
7.9.1 WinCan-compliant surveys – option.....	238	12.2 Drums and PSU.....	265
8 WinCan PC connections.....	240	12.3 Crawlers .....	266
8.1 Ethernet connection – no router .....	241	12.4 Elevators .....	267
8.2 Ethernet connection – via router.....	248	12.5 Lighthead .....	268
9 Status icons.....	255	12.6 Crawler cameras .....	268
10 Maintenance and cleaning.....	256	12.7 Crawler wheels and spacers.....	269
10.1 Maintenance .....	256	12.8 Controller to drum/PSU link cables .....	270
10.1.1 Storing the system .....	256	12.9 Crawler-wheel-elevator configurations	271
10.1.2 Connection points, terminals and O-rings .....	257	12.10 Crawler configuration examples.....	273
10.1.3 Rod guide assembly (pushrods only).....	258	12.11 Pushrod reel and rod specifications ..	274
10.2 Cleaning the system.....	259	12.12 Pushrod camera specifications .....	275
10.3 Factory reset .....	260		

13 Open Source Software .....	276
14 Index .....	277
Contact us .....	284

# 1 Introduction

The C550c is an advanced pipeline video inspection system that is ideal for a broad range of applications. It allows operators to precisely identify and document pipeline faults using digital video recording.

Rugged and weatherproofed, the system is designed for use in harsh conditions. It is easy to transport and deploy, enabling quick and successful inspections.

The C550c controller can drive any combination of compatible pushrod reels and cameras. Its 12.1" (307mm) screen displays the camera's video feed, stored videos and photos, and configuration settings. You operate the controller using its built-in buttons and keyboard.

If required, you can connect the controller to external video equipment (input and output), to a headset with microphone, and to an external keyboard.



*Fig. 1.1: flexitrac C550c system with Powered Drum and selected crawler options*



## 1.1 C550c features

The C550c inspection system offers the following features:

- One-touch video recording to MP4 format.
- One-touch still images captured to JPEG format.
- Rotate the video feed while recording live video.
- Survey data stored on high capacity (128GB) built-in solid state storage.
- Rechargeable battery and external power supply options.
- Integrated survey reporting.

Survey reports, videos and observation photos, can be exported to USB memory sticks, sent as email attachments or uploaded to DropBox. MSCC3 through MSCC5 survey standards are supported. Surveys can also be performed using the integrated WinCan option, subject to additional licensing.

- Modular system, fully compatible with any combination of flexitrax™ C550c drums, crawlers and cameras and is also compatible with flexiprobe™ C540c rods, reels, cameras and accessories.

**Note:** *References to P350, P354 and P356 systems and crawlers in this document also refer and apply to P550c, P554 and P556 systems and crawlers and C550c, 554 and 556 systems and crawlers.*

## 1.2 Definitions

- **Zero distance:** Your survey needs to accurately record the distance of the camera from the starting manhole so that pipe defects and features can be accurately located. However, in most cases you will need to unwind the pushrod some distance so you can deploy the camera down into a manhole before starting the pipe survey.

To ensure camera distances are recorded accurately in your survey videos and observations, you need to zero the camera distance ('set a zero distance') when the camera is in position before you start the survey. See [page 170](#) where this is described for pushrod systems and the same principle applies for crawler systems.

Setting a zero distance is also known as *zeroing the cable or rod counter*.

- **Crawler and tractor:** both these terms are used in this document to refer to the motorized, wheeled vehicle that is used to transport a camera.

## 1.3 Safety notices

Caution must be taken when conducting any pipeline or drainage system inspection. Please observe all safety warnings detailed in the Preface (see [page 8](#)) and throughout this operation manual.

Before you operate the C550c system, we recommend that you familiarize yourself with any additional health and safety requirements that may be defined by company policy and any applicable local or

national laws. Contact your company's or local government's health and safety officer for further information.

## 1.4 Training

CUES provides training services for most CUES products. Our qualified instructors will train equipment operators or other personnel at your preferred location or at CUES facilities. Training in best practices can lead to improved efficiency, avoid workplace accidents, how to diagnose and repair simple issues, as well as facilitating longer product lifetimes.

For more information go to [www.cuesinc.com](http://www.cuesinc.com) or contact your local CUES representative.

## 1.5 Updates and latest information

CUES may have released new system software, user documentation or other information after you purchased your system. You can download the latest software, documentation and application notes from [www.cuesinc.com](http://www.cuesinc.com).

For information about checking and upgrading your system's software, see [page 261](#).

## 1.6 CUES technical support

If you need technical assistance, please contact [rd\\_support@spx.com](mailto:rd_support@spx.com). Or visit [www.pearpoint.com](http://www.pearpoint.com).

## 2 Quick Start

**Note:** *This section provides quick start instructions for experienced users only. We recommend that new users read this manual fully before proceeding.*

To get started with the C550c system, follow these steps:

- 1 Make sure the PSU, whether separate or part of the powered drum, and controller are both powered off.

**Note:** *This Quick Start section assumes that the controller battery is charged. For details about charging the battery, see [page 87](#).*

- 2 Set up the controller:
  - a. (Optional) Mount the controller onto the drum using the supplied clamp.
  - b. Connect the drum to the controller using the link cable (item 4 on [page 31](#)).
  - c. Connect the drum to the down-hole equipment relevant to the survey required.
- 3 Turn the power switch on the PSU and press the power button on the controller to turn the system on.

The controller takes around 15 seconds to display the first screen.

*Important!* The controller displays the Equipment settings menu. If the Equipment settings menu is showing the equipment currently attached to the controller, then press Select. Otherwise, change the equipment as necessary, highlight Continue, then press Select.

For full details about these steps, see [page 136](#).

- 4 Deploy the crawler and camera into the pipe as required.
- 5 Zero the camera distance, as required, using the **0.00** button.

For details, see [page 147](#).

- 6 Create a survey and start recording your survey video.

For details, see [page 196](#).

## 3 System overview

The flexitrac C550c pipeline video inspection system comprises of a controller, powered cable drum or manual cable drum plus PSU, crawler, camera and accessories.

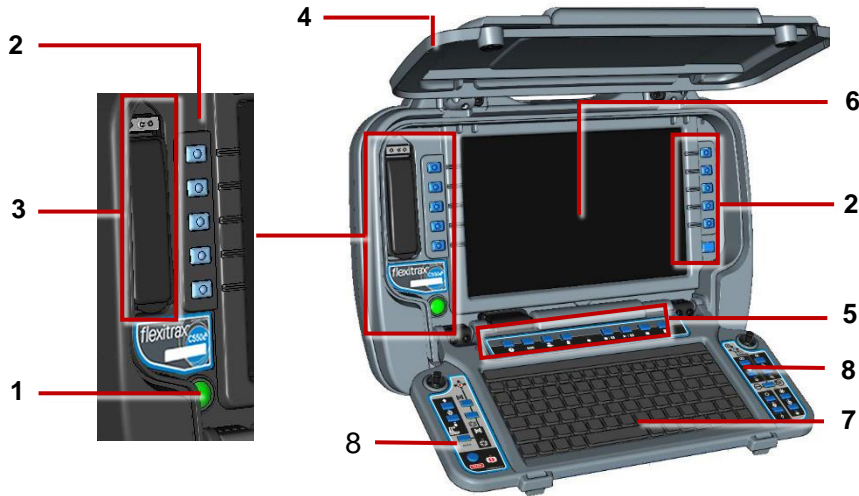
### 3.1 Controller

The C550c controller is the command module, digital video recorder and playback device. Video is displayed on a 12.1" (307 mm) high definition, industrial TFT LCD screen. Video, pictures and inspection reports are stored on a high-speed, high capacity (128GB) internal solid state storage.

The C550c controller is compatible with the full range of C550c drums, crawlers, cameras and accessories as well as the full range of C540c cameras, reels and accessories, providing unmatched modularity and inspection capability from 1¼" (30mm) pipes all the way to 59" (1.5m).

The C550c controller has an internal, rechargeable lithium-ion battery. A fully charged battery will power the controller for around 4 to 6 hours, depending on usage factors such as recording/playing back, display brightness etc.

### 3.1.1 Controller front view



*Fig. 3.1: Controller, front view*

1 **On/Off button:** Switches power ON or OFF.

When the system is powered on, the on power indicator on the handle lights up.

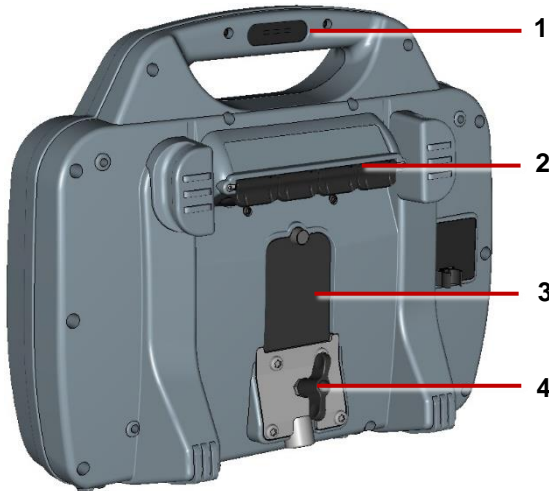
2 **Buttons:** Allow you to navigate screen menus and control the system.

- 3 **Protected USB and audio sockets:** The covered compartment contains a USB socket and audio socket. The cover protects against water and dust.  
  
Use the USB socket to connect a USB memory stick (for example, to install software upgrades).  
Use the 3.5mm audio socket to connect a headset with microphone for adding an audio commentary to survey videos.
- 4 **Handle-mounted status indicators:** On the back and front of the handle, LEDs indicate the controller's WiFi, Power and Battery Charge status; see [page 30](#).
- 5 **Panel buttons:** Allow you to record and play survey videos, make observations and take photos, mute the microphone, turn the camera sonde on and off, and zero the camera distance; see [page 33](#).
- 6 **Display:** LCD screen shows video, still images and system information.
- 7 **Keyboard:** Use for text entry when setting up surveys and configuring the controller. Use shortcuts to control, when enabled, the movement of the crawler, powered drum and camera; see [page 105](#).
- 8 **Buttons and joysticks:** Use to control, where applicable, the movement of the crawler, powered drum and powered elevator; zoom and focus of the camera, and brightness of the lighting.



### 3.1.2 Controller rear view

On the rear of the controller are the main and auxiliary connection panels, and the support clamp.

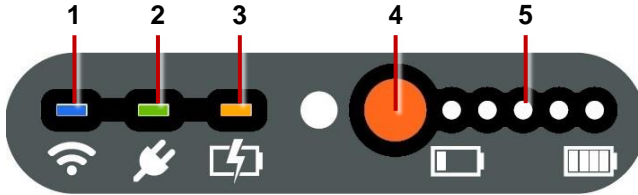


*Fig. 3.2: Controller, rear view*

- 1 **Handle-mounted status indicators:** On the back and front of the handle, LEDs indicate the controller's WiFi, Power and Battery Charge status. See [page 30](#).
- 2 **Main connection panel:** Includes a socket for the link cable to the pushrod reel, an external video input, and Ethernet connection and the power socket. See [page 31](#).
- 3 **Auxiliary connection panel:** Includes an HDMI output, dual USB ports, and a battery fuse. See [page 32](#).
- 4 **Controller support clamp:** For mounting the controller onto the drum.

### 3.1.3 Handle-mounted status indicators

On the back and front of the handle, LEDs show the WiFi, Power and Battery Charge status.



*Fig. 3.3: Status indicators on controller handle (front view)*

1 **WiFi:** Lights up when WiFi is enabled on the controller.

**Note:** *This LED indicates only that WiFi is enabled and the controller can detect available WiFi networks. It does not indicate that the controller is connected to the internet!*

2 **Power:** Lights up when the controller is powered on (green).

3 **Battery charge:** Lights up while battery charging is underway (amber). When the battery is fully charged, the LED changes to green.

**Note:** *Also indicates the controller is connected to an external power supply (mains or vehicle).*

4 **Battery check button:** Press to check the battery level.

5 **Charge status lights:** When the battery check button is pressed, these lights show the battery level.

### 3.1.4 Main connection panel

The main connection panel includes the power socket, a socket for the link cable to the reel, and an external video input. Each socket has an individual cover.

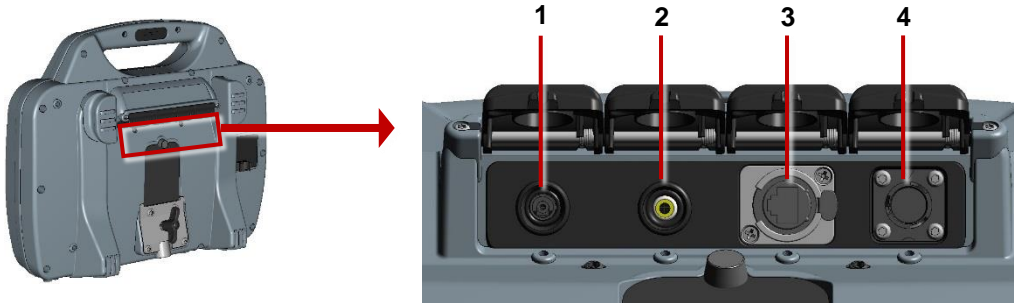


Fig. 3.4: Main connection panel

1 **Power socket:** DC power input from mains supply or vehicle supply.



**Warning!** Use only the supplied battery chargers (mains or optional vehicle).

2 **Video input:** An RCA video jack provides an input from external video equipment (optional).

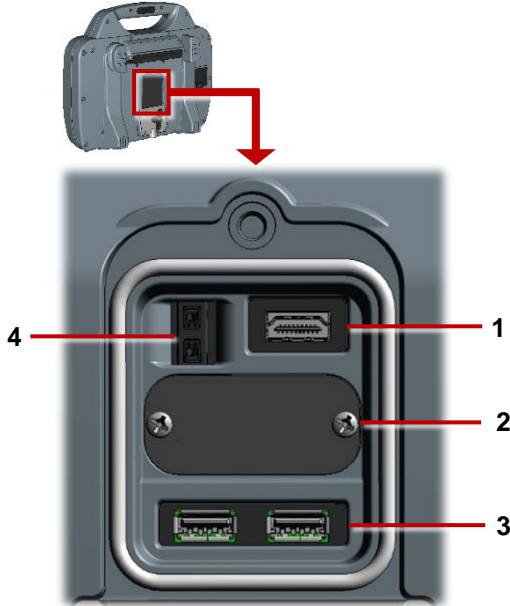
3 **Ethernet port:** Used for remote control operations, connections to an external WiFi access point etc.

4 **Socket for link to cable drum:** Connects the controller to the crawler-mounted camera. Tighten the connector finger-tight, but do not use a wrench, spanner or pliers.

### 3.1.5 Auxiliary connection panel

**Caution:** Only open the auxiliary connection panel in a dry, clean environment.

The auxiliary connection panel includes a video output and two USB ports:



- 1 **HDMI output:** Allows you to display live video on an external monitor. (Video replay on an external monitor is not currently supported.)
- 2 *For manufacturer use only.*
- 3 **USB sockets:** Allows you to connect a USB memory stick or external keyboard.
- 4 **Fuse holder:** For a 5A MINI Blade fuse. The fuse is supplied separately with the controller; you must insert the fuse before operating the controller.


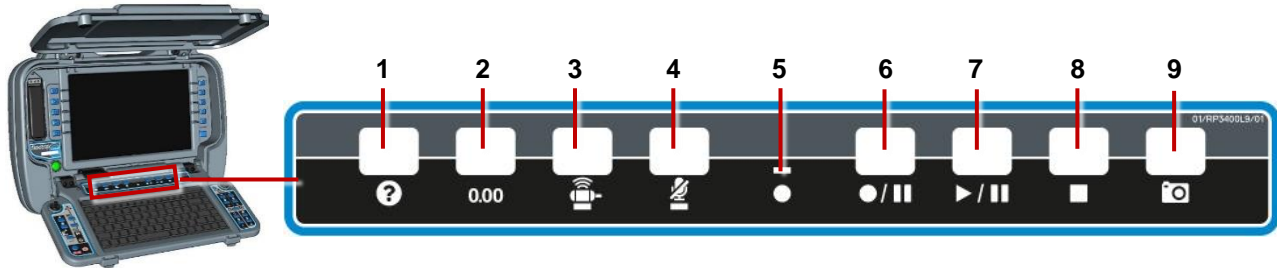
 **Warning!** You must remove the fuse to isolate the battery when the controller is transported by air!

Fig. 3.5: Auxiliary connection panel

### 3.1.6 Panel buttons


Use these buttons to record and play videos, take photos, set a zero distance and mute the mic.



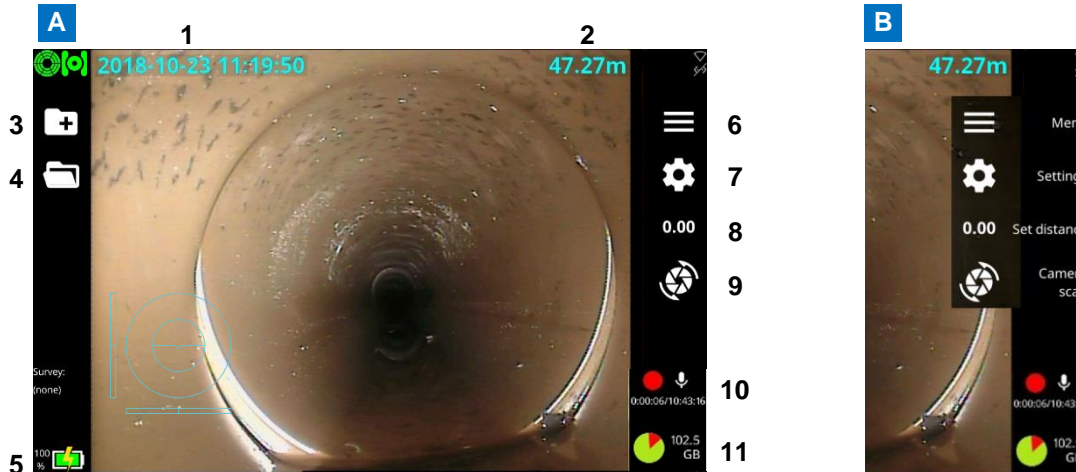
*Fig. 3.6. Panel buttons*

- 1 **Help:** Displays the C550c operation manual.
- 2 **Zero the camera distance:** See [page 147](#) for details.
- 3 **Sonde LED:** Green when active.
- 4 **Mute microphone:** LED is red when microphone or headset is muted.
- 5 **Recording LED:** Red when video recording in progress.
- 6 **Record / pause:** Press to start or pause video recording.
- 7 **Play / pause:** Press to play or pause video playback.
- 8 **Stop:** Press to stop video playback or recording.
- 9 **Camera:** Press to take photo and make an observation; see [page 224](#).

## 3.2 Controller home screen

**Note:** Press the  **Back** button one or more times to return to the home screen.

The home screen lets you create and manage surveys, configure system settings, and rotate the video feed. It also shows real-time system information, crawler distance since being zeroed (see [page 170](#)) and the Mimic™ (see [page 164](#) for information provided by this graphic). If required, you can overlay these details in your survey videos and observation photos.



*Fig. 3.7: Controller home screen. A Button labels hidden. B Button labels shown. See next page for descriptions.*

*Controller home screen, continued*

- 1 **System date and time**
- 2 **Crawler distance.** Also called the distance counter.
- 3 **Create survey button.** Press to set up a new survey.
- 4 **Existing surveys button.** Press to manage surveys stored on the controller.
- 5 **Battery charge & Survey title**
- 6 **Menu button.** Shows or hides button labels.
- 7 **Settings button.** Opens the system menus.
- 8 **Set distance button.** Press to zero the camera distance for a new survey.
- 9 **Joint scan button.** Press for Cameras with Tilt function to perform a joint scan. For other cameras, press to rotate the video feed on the screen clockwise (9a) or anticlockwise (9b).
- 10 **Recording and mic status**
- 11 **Free disk space (GB).** Shows free space on the controller's internal solid state storage. A pie graphic shows free (green) and used (red) space.

## 3.3 Controller battery

The C550c controller has a lithium-ion (Li-ion) rechargeable battery.

Li-ion batteries have excellent power to weight ratios and can offer very long lifetimes. Some simple steps to prolong the life of your Li-ion battery are outlined below.

### 3.3.1 Battery care

- Do not **discharge** the battery too much; do not **charge** the battery too much.  
Try not to discharge below 10%, or charge above 90%. This will dramatically increase the number of charge and discharge cycles that the battery can achieve.
- Only charge your battery at temperatures of 10-40°C (50-104°F). See below for more details.
- Keep the power socket clean and dry at all times. Keep the main connection panel closed when the controller is not in use. See the image on [page 29](#).

### 3.3.2 Temperature

Battery life is affected by the temperature while charging the battery. At lower temperatures (below 50°F or 10°C), chargers will lower the charging rate to reduce battery degradation. CUES therefore recommends that you only charge the battery at temperatures of 50-104°F (10-40°C).



### 3.3.3 Battery life

With typical constant usage, the C550c controller battery will last around two years. For advice on replacing the battery, see [page 92](#).



*Do not attempt to replace the battery yourself!*

## 3.4 Cable drums

The system supports either a powered or manual drum that can accommodate cable lengths of 330' (100m), 495' (150m), 660' (200m), 820' (250m) and 1000' (305m). The powered drum contains an integral power supply whilst the manual drum requires an external power supply unit (PSU).

The cable drum cassette in the powered drum is user-replaceable. Refer to the Appendix for instructions on how to remove and install the cable drum cassette.

Please contact your local representative or visit [www.cuesinc.com](http://www.cuesinc.com) for a complete list of spares and accessories.

### 3.4.1 Powered drum



*Fig. 3.8: Powered drum, including integrated PSU, showing how the command module is mounted.*

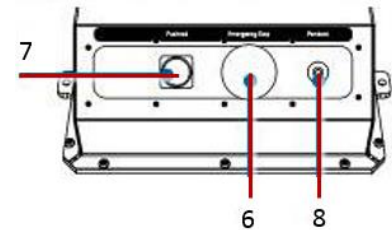
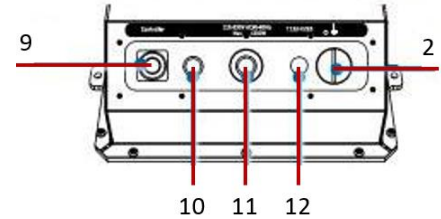
1. Command module support stand.
2. System on/off switch

**Note:** the C550c controller has a separate on/off switch

3. Command module.

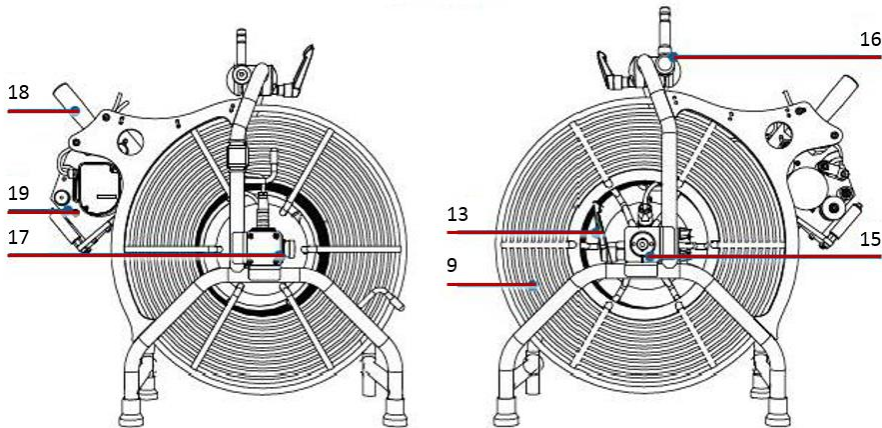
4. Reel compartment: Houses up to 305m (1000') of cable wound onto the drum cassette.
5. Handle bars, wheels and removable handles: Allow you to maneuver the system easily into position.
6. Emergency stop: Instantly shuts off system power. When initiated, the system must be reset.
7. Pushrod connector: Connect and power compatible 540 pushrod systems to your C550c controller.
8. Pendant Controller connector, for joystick/button control of system.
9. Command module connector: To connect the command module link cable.
10. Power on/off indicator. A White LED lights up when the PSU is switched on and powered up.
11. Power supply socket: To connect mains power.
12. Cable rollers.

### 3.4.2 Manual drum and PSU



- 13. Cable drum: Houses up to 305m (1000') of cable.
- 14. Cable brake.

15. Crank handle socket.
16. Command module support clamp.
17. PSU link cable socket.
18. Manual layering handle: To assist with laying cable evenly on the drum.
19. Cable rollers.
20. Link cable connection for manual drum.



### 3.4.3 Crawlers and Cameras

The system offers two crawlers: the P354 (100mm/4" diameter) and the P356 (150mm/6" diameter).



*Fig. 3.9: P354 crawler with Forward View camera installed and P356 crawler with pan, tilt and zoom camera, large elevator and lighthouse installed.*

Both crawlers are compatible with a choice of three color cameras. The P550-CAM-FW is a fixed, forward view camera. The P550-CAM-PT offers pan and tilt and the P550-CAM-PTZ offers pan, tilt and 10x optical zoom.



*Fig. 3.10: The three camera options available for the C550c system.*

C550c systems offer automatic TILT protection. By default, this will halt the crawler in hazardous tilting situations, when its roll first exceeds 35°. The user will be shown a tilt hazard warning, and can restart the crawler movement if necessary. The user can change this behavior to warn only, without stopping the crawler, or can disable the warning altogether.

## 3.5 Pushrod reels

### 3.5.1 Reels

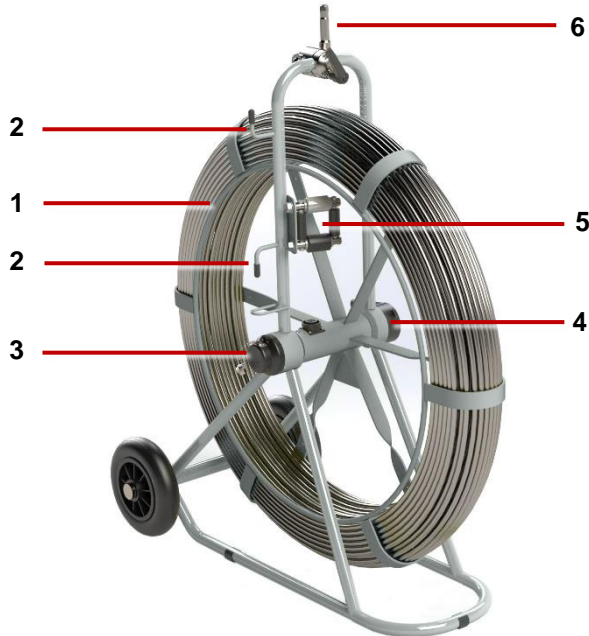
The reel (or coiler) holds the pushrod-and-camera on a revolving drum. The C550c system supports the reels below. See [page 275](#) for reel specifications.



*Fig. 3.11: C550c pushrod reels. 1 543c reel. 2 542c reels, available in two lengths. 3 541c reels: standard reel and extra-flexible Plumbers reel.*



### 3.5.2 Reel features



- 1 **Pushrod reel:** The pushrod can be up to 500ft (150m) in length, depending on reel type.
- 2 **Stowage hooks:** Use for storing the link cable on the pushrod reel.
- 3 **Link cable socket:** Connects the link cable to the reel.
- 4 **Brake:** *Not shown.* Located on reverse side of reel. Adjustable to control the movement of the reel, or to lock it.
- 5 **Pushrod guide:** Guides the rod on and off the reel. Must be kept clean.
- 6 **Adaptor clamp:** Allows the controller to be mounted onto the pushrod reel.

*Fig. 3.12: Reel features  
This example shows a 543 reel.*

### 3.5.3 Cameras

Three color camera options are available:



*Fig. 3.13: P540c pushrod cameras*

- 1 **1" (25mm) diameter camera** for up to 4" (100mm) diameter pipes
- 2 **1¼" (32mm) diameter self-leveling camera** for up to 6" (150mm) diameter pipes
- 3 **2" (50mm) diameter self-leveling camera** for up to 9" (230mm) diameter pipes

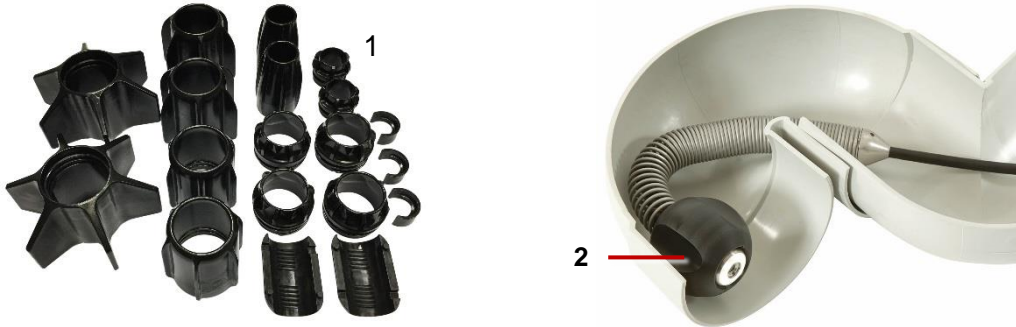
### 3.5.4 Flexi and sondes



Fig. 3.14: Universal flexi and sondes

- 1 **Universal Flexi:** *(Optional purchase)* Attaches to the end of the pushrod helping the camera to negotiate small radius bends.
- 2 **Sonde:** *(Optional purchase)* Attaches to the end of the pushrod and transmits a signal, allowing the sonde's position to be pinpointed using a CUES locator such as an Accupoint MS610 or a Radiodetection RD5100S or RD7100DL.
  - 2a Flexisonde
  - 2b Solid Sonde
  - 2c *(Plumbers reels only)* Non-detachable Plumbers sonde

### 3.5.5 Skids



*Fig. 3.15: Skids and skidball*

- 1 **Universal skids:** Protect the camera during use and center the camera in the pipe. For instructions on how to prepare the skids and cameras for use, see [page 83](#).
- 2 **Plumbers skidball:** For 1" (25mm) cameras, this skidball allows movement around most 2" (50mm) traps and 1.25" (32mm) bends. Available in 1.4" (36mm) and 1.6" (42mm).

## 4 System assembly

The system can be setup in a large number of ways, depending on your survey requirements. This section provides details on system assembly. You will as a minimum require an Allen key set and a range of general purpose screwdrivers.



**Warning!** *Before you assemble the system, switch off the controller.*

**Caution!** If using a generator, ensure that this is compatible with the C550c system. Refer to the Generator Selection paragraph in the preface of this document for further information.

**Caution!** Before attempting to assemble the system, ensure that the power is switched off.

**Caution!** Check that all the link cables are connected as per instructions.

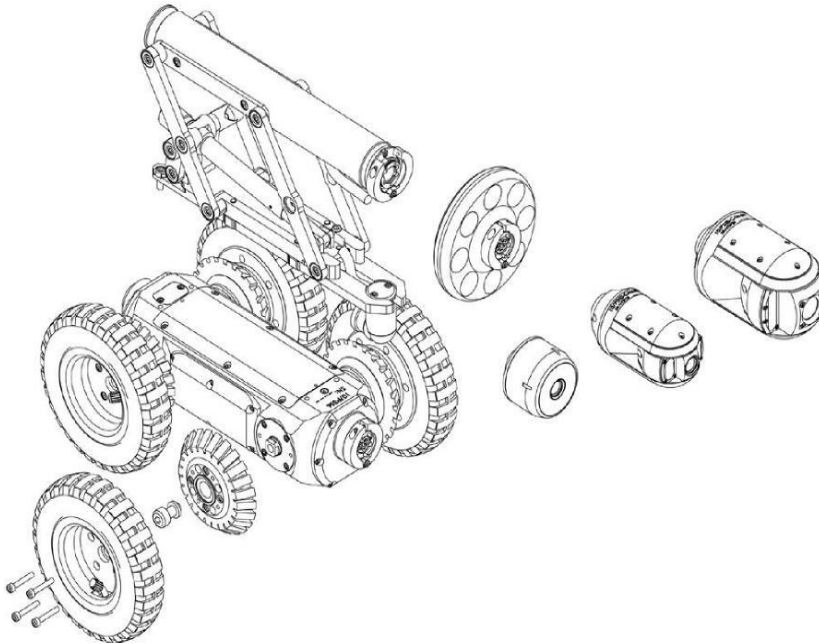
**Caution!** Do not replace the C-Clamp modified screws (at rear of tractors and cameras) with standard 'off the shelf' screws, as these have not been designed to secure connection.

### 4.1 Crawler, Camera and accessories

The P354 and P356 crawlers have a variety of wheels, tires, cameras and accessories to suit your survey. The figure below demonstrates some of the options available.

**Caution!** You must configure the appropriate wheel-set connected in the Settings > Controller > Equipment > Tractor wheel size

menu, incorrect wheel settings will cause motor strain, incorrect behaviors and early life failure on the crawlers.



*Fig. 4.1: P356 crawler assembly, showing some of the options available*

### 4.1.1 Crawler weight (P354 Only)

The crawler weight is a metal plate designed to increase traction by adding more weight to the crawler. Attach the weight on the crawler body before attaching other wheels and accessories, then secure with the provided screws.

### 4.1.2 Wheels and tires

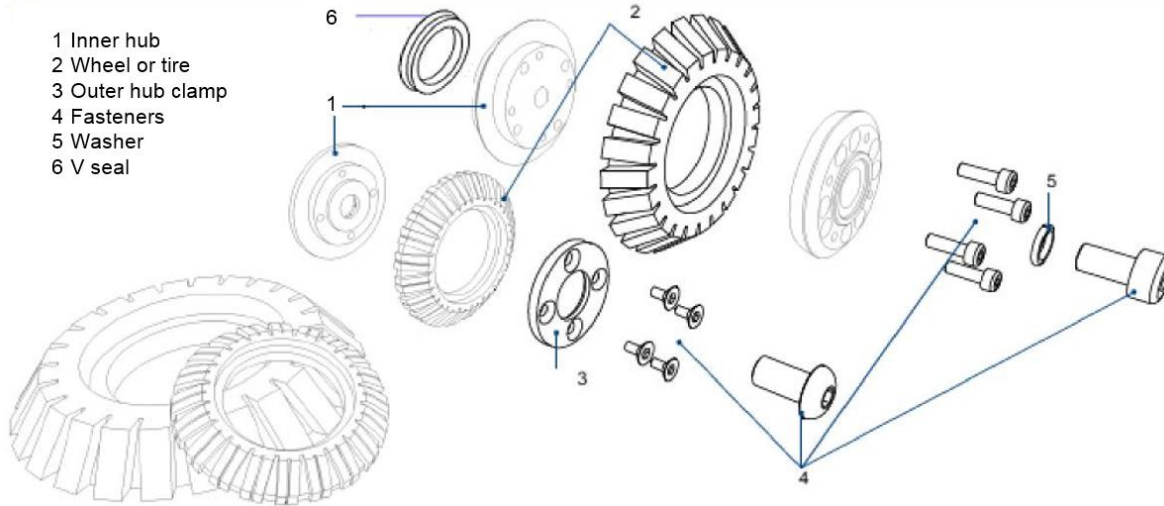
The P354 uses the small and medium wheel sets. These can also be 'doubled-up' to improve traction in larger pipes. Its recommended range is between 4½" and 15" (60mm to 305mm). The small wheels are 62mm / 2.5" diameter and the medium wheels are 110mm / 4.3" diameter.

The P356 uses small, medium and large wheels, which can also be 'doubled-up' to improve traction. This allows its use for centralized survey of pipe diameters between 6½" and 36" (165mm and 900mm). The P356 Compact Cradle and Cradle, with an elevator, allow centered inspection of pipes to a maximum of 60" / 1500mm.

The small and medium wheels come with hard or soft tire material options to suit different grip requirements. The large wheels are 170mm / 6.7" in diameter.

**Note:** *although it will work electrically and mechanically, we do not recommend use of a PTZ camera on a P354 Crawler due to the weight and size of the camera.*

### Connecting wheels and tires



*Fig. 4.2: Connecting various tires (top) and the abrasive wheels (below)*

**Note:** Item 6 “V-seals” prevent debris ingress into the crawler seals on the medium and large wheel sets. It is beneficial to check and replace these at regular intervals or ask our service teams to do so. 4x part 04/B1525510

## Specialist Wheels

### Abrasive (rasp) wheels



The abrasive wheel kits have been designed to enhance grip, boosting the distance and capability of your flexitrac C550c system in a wide-range of applications. Particularly recommended for **brand new plastic, greasy, or 'relined' pipes** where grip with standard rubber wheels can be challenging.

These are available in 5 kits with suitable adaptors for pipe size (6", 8" and 9" pipes). The small abrasive rasp wheels should use the 62mm wheel size setting, while the large abrasive rasp wheels should use the 110mm wheel size setting.

### 84mm 'Slim Profile' Wheels

84mm wheels improve performance in areas where the pipe diameter decreases, typically joint offsets and areas with reasonable debris buildup. The slimmer profile of the unit allows a greater chance of passing through these tight areas. Adaptors are required to attach these wheels to the C550c.



*Fig. 4.3: Abrasive wheels fitted to a P556*



*Fig. 4.4: Kit of 84mm wheels*

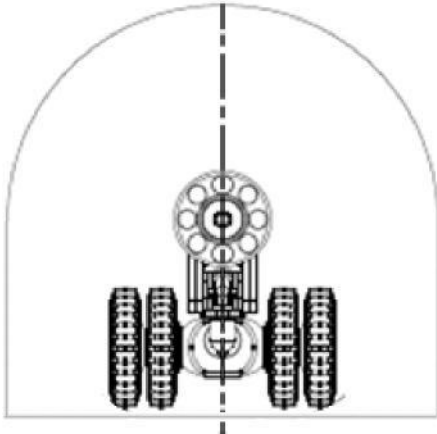
**Caution!** When using the 84mm wheels with the 84mm wheel adaptor, select 84mm size wheels in the

Settings > Equipment > Tractor wheel size

menu. Failure to do so may cause stress to the tractor motors and cause early life failure.

### Double-large wheel adaptors & configuration

Comprised of 2 full sets of P356 Large wheels (8x) and (4x) adaptors, allowing the large wheels to be mounted in a tandem configuration. Designed to increase surface area and grip helping to navigate silted culverts and pipes.



*Fig. 4.5: An illustration of the P356 with the 'double-large-wheel' configuration for added surface area and grip*

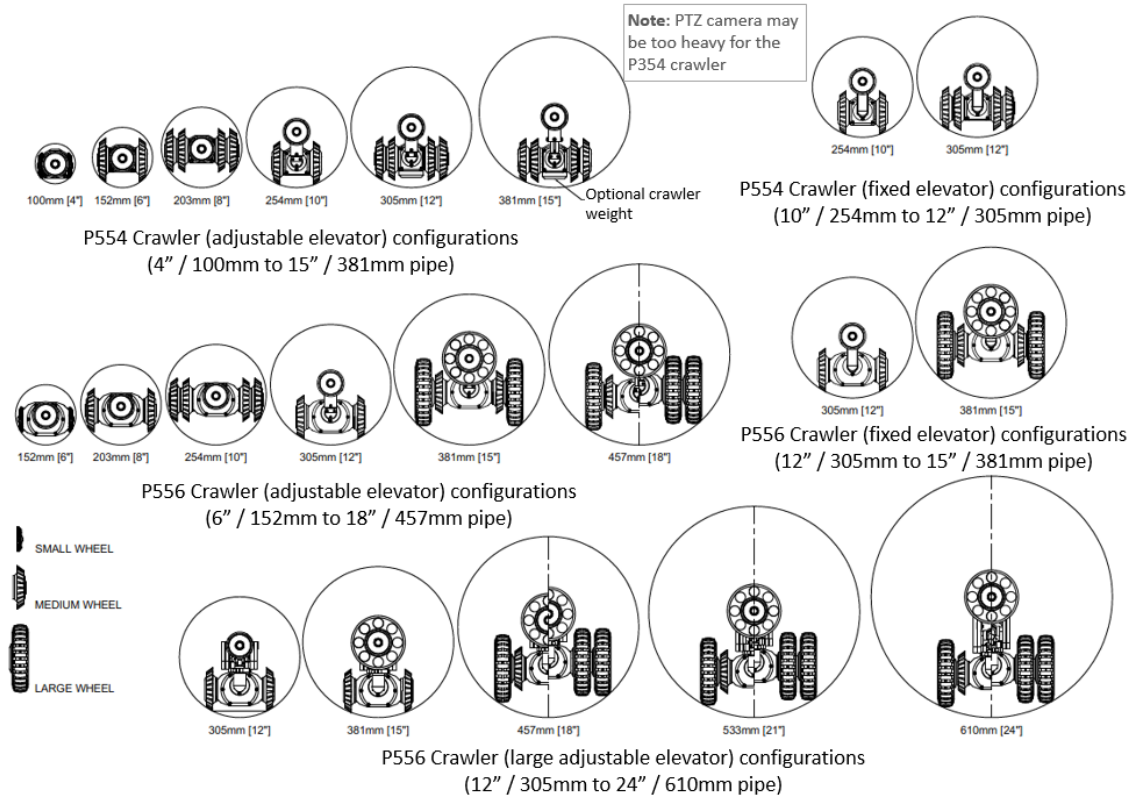
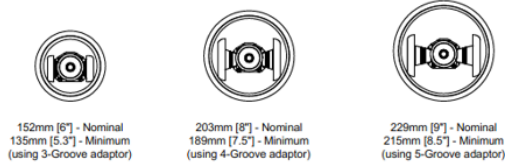
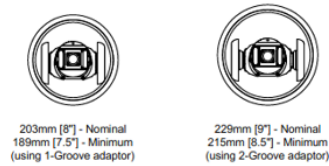


Fig. 4.6: Pipe clearance diagrams, part 1



P554 Crawler (adjustable elevator) configurations  
 (6" / 152mm to 9" / 229mm pipe)



P556 Crawler rasp wheel configurations  
 (8" / 203mm to 9" / 229mm pipe)

*Fig. 4.7: Pipe clearance diagrams, part 2*

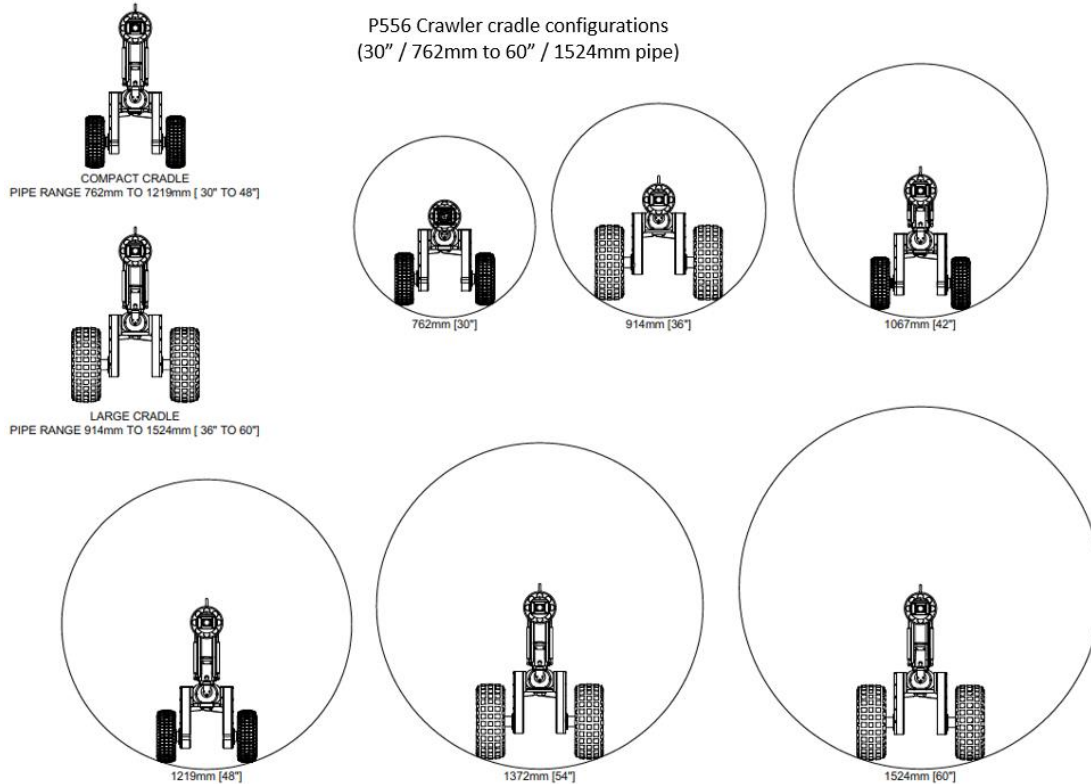


Fig. 4.8: Pipe clearance diagrams, part 3

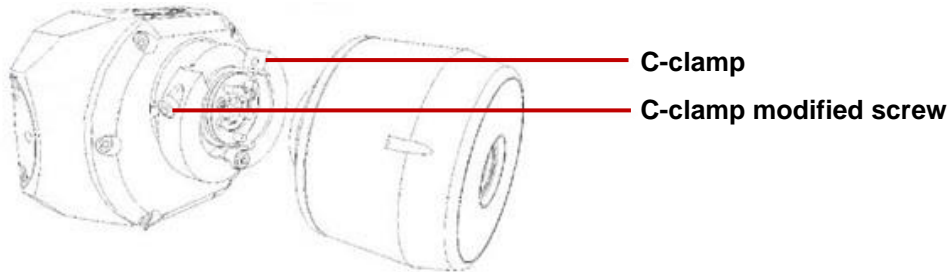
### 4.1.3 Cameras

The P354 and P356 have three high- resolution cameras, with PAL or NTSC versions available. All cameras offer remote focus capabilities and use the latest ultra-bright LEDs for optimum lighting.

Cameras can be fitted direct to the crawler's body (or to an elevator or lighthouse). The cameras can only be fitted in one alignment. A single 3mm Allen key screw is used to secure the camera to the crawler.

#### Connecting cameras

Cameras are connected using the C-clamp connection, the procedure is the same for all three cameras.



*Fig. 4.9: Connecting a Forward View camera*

### **Forward View camera**

P550-CAM-FW: this robust and compact camera offers a focal range from 10mm to infinity and a 120 lm light source.

### **Pan and Tilt camera**

P550-CAM-PT: The Pan and Tilt camera allows clear vision of pipes. With focal range from 10mm to infinity; featuring a 210 lm light source.

### **Pan, Tilt and Zoom camera**

P550-CAM-PTZ camera also includes auto-focus, 10x optical zoom with a focal range of 10mm (WIDE) to infinity, featuring a 420 lm light source.



*Fig. 4.10: Left to right - Forward view, Pan and Tilt, and Pan, Tilt & Zoom cameras*

#### 4.1.4 Elevators

The P550 elevators are used to elevate the camera and help center it in pipes 10"(254mm) in diameter or larger. The P550 system offers a choice of elevators:

- Fixed elevator. The fixed elevator will deploy the P354 in pipes up to 12" (300mm ) and the P356 in pipes up to 15" (380mm ).
- Adjustable elevator. The adjustable elevator will deploy the P354 in pipes up to 15" (350mm) and the P356 in pipes up to 18" (458mm ).
- Large adjustable elevator (For the P356 only).The large adjustable elevator will deploy the P356 in pipes from 12" (300mm) up to 24" (610mm).
- P356 powered elevator. To deploy the P356 in pipes from 12 to 36" (305mm to 900mm). This elevator can be remotely controlled from the command module



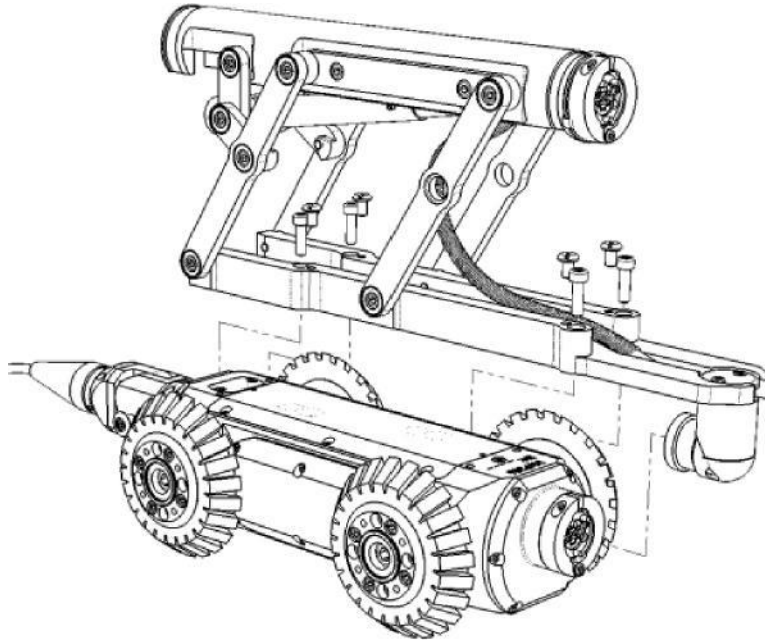


*Fig. 4.11: P550 elevators. Left to right – Fixed elevator, Large Adjustable elevator and Powered elevator*

### **Large adjustable elevator**

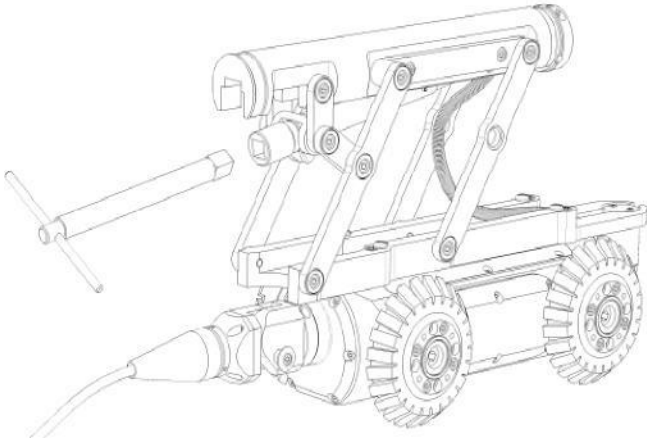
To fit the large adjustable elevator to the P356 crawler, follow these steps.

- 1 Align the four mounting holes and secure the elevator to the crawler using the four screws provided, as shown below.



*Fig. 4.12: Installing the large adjustable elevator*

- 2 To adjust the height of the elevator, use the supplied chuck key to twist the square, recessed socket, as shown below.

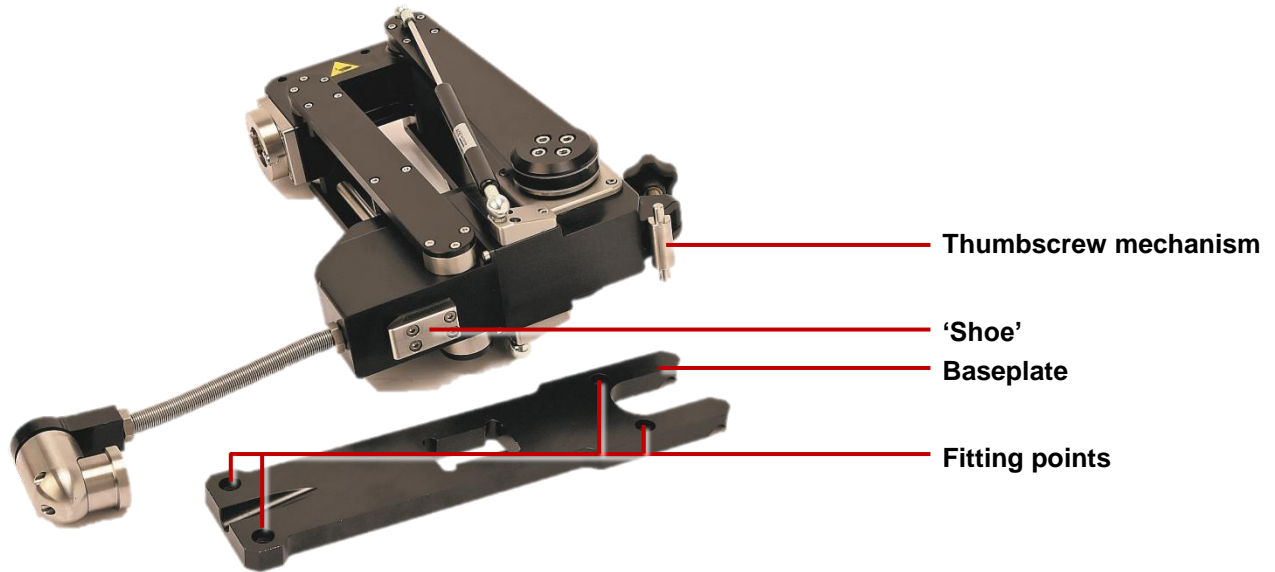


*Fig. 4.13: Adjusting the large adjustable elevator*

### **Powered elevator**

Install the powered elevator using the following steps:

- 1 Fit the baseplate to the top of the P356 crawler using the four mounting screws provided



*Fig. 4.14: Installing the powered elevator*

- 2 Loosen off the thumbscrew at the rear of the elevator so that there is plenty of play in the mechanism
- 3 Line the elevator up with the P356 crawler, and slide the 'shoe' projecting from the bottom of the elevator into the corresponding recess in the baseplate

- 4 The thumbscrew mechanism should engage with corresponding recesses in in the baseplate. Once located, tighten the thumbscrew to fix the elevator to the crawler.
  - 5 The electrical connection can then be fitted to the front of the crawler as normal.
- Once fitted, there is no need to remove the baseplate even when inspecting smaller pipes.

### Setting the powered elevator height



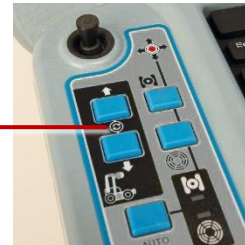
**Warning!** *Never place hands, clothes or foreign objects into the mechanism of the powered elevator.*

**Caution!** Do not lift the crawler using the powered elevator, unless using the supplied lifting eye (shown at right)



The P356 powered elevator can be used to center the system camera in the pipe being surveyed. The elevator can be controlled using the dedicated elevator control keys on the left hand side of the keyboard.

Elevator control keys



**Note:** *When reversing the system, we recommend you to set the elevator to its minimum height unless centering is required.*

**Note:** *in some configurations and pipe materials, steering sensitivity may be affected at high camera elevations.*

### **Auxiliary Lighthouse**

This can be used to provide the camera with more light. With more light you can deploy the crawler in larger pipes or in pipes made from light-absorbent material that would otherwise reduce visibility. The lighthouse is fitted between the camera and the crawler or between the camera and the elevator. The lighthouse provides up to an additional 850 lm.

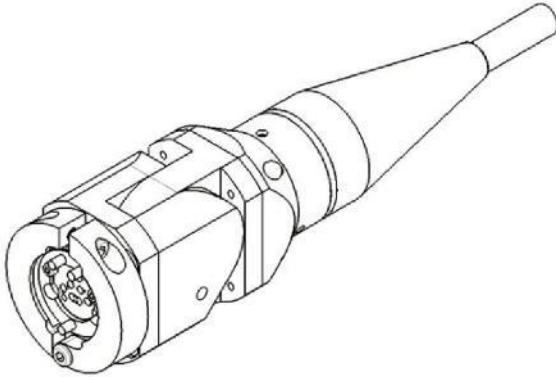


*Fig. 4.15: Auxiliary lighthouse*

#### **4.1.5 Crawler connection**

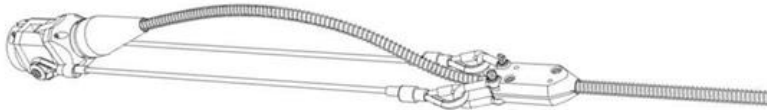
Once you have fitted the crawler with the cameras, wheels and other accessories, you can connect it to the cable drum.

Connect the crawler cable termination to the terminal on the back of the crawler's body using a 3mm Allen key to tighten the cable termination's C-clamp.



*Fig. 4.16: Cable termination*

**Caution!** Older products may feature a strain relief assembly and a stainless steel spring guard at the cable end, as shown below. Contact CUES for assembly details.



*Fig. 4.17: Old-style cable termination – contact CUES for assembly details*

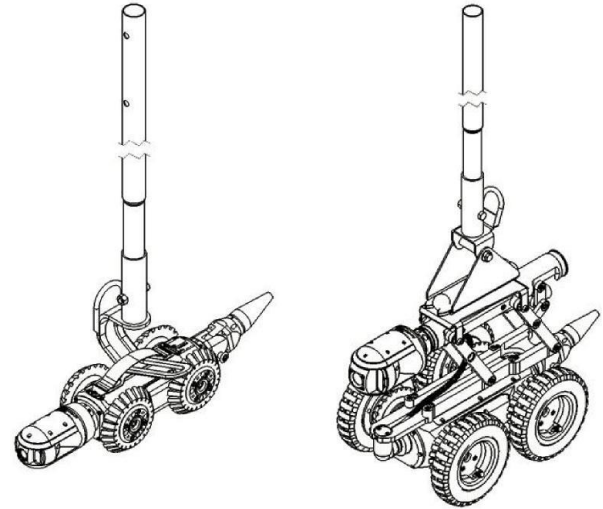


### 4.1.6 Crawler deployment tools

The crawler deployment tools for the P354 and P356 crawlers are optional accessories that allow you to safely deploy and remove a crawler into manholes, culverts and other access points. The deployment tools can deploy and remove the crawler in conduits up to 16.5' / 5m\* deep.

\*Using all 3 of the supplied poles.

Refer to [page 138](#) for a guide to crawler deployment



*Fig. 4.18: Deployment tool*

## 4.2 Drums & External PSU

The external PSU connects to the manual drum using the link cable. The single end connects to the manual drum and the split end terminals connect to the manual drum connection panel on the rear side of the PSU's handle.

MK3 system connectors are not compatible with MK1 and MK2 sockets. Contact CUES or your local distributor for the latest compatibility options.

**Caution!** The external connectors must be properly sealed by the blanking caps provided, or by using the correct leads to prevent water damage. Under no circumstances are these connectors to be left un-blanked.

**Note:** *The Powered drum is capable of winding in deployed cable. When retrieving the cable, the drum will rewind slightly faster than the crawler is reversing, in order to keep tension on the cable. This is normal operation.*

## 4.3 Command module

### Mounting

Mount the command module to the drums using the support column or stand. The height can be adjusted on the powered drum support column.

### Power, data and video

When using the manual or powered drum, a single link cable supplies the command module with power, data and video. The link cable socket is located on the back of the controller.



*Fig. 4.19: C550c rear connections*

Connect the other end of the link cable to the controller terminal on the powered drum or external PSU.



*Fig. 4.20: Link cable connector on manual PSU. The connector on the Powered Drum is also marked “Controller”*

### External monitor

An external monitor can be connected to the C550c controller using a high quality HDMI cable. Plug the cable into the HDMI socket located beneath the waterproof rear cover.

**Caution! Only use the HDMI connection in a dry environment such as an in-vehicle installation.**

## 4.4 Controller

### 4.4.1 Mounting on the drum

If required, you can mount the controller on the powered or manual drum with the supplied clamp, or onto the optional vehicle wall mounting kit; the height can be adjusted on the powered drum support column. Tighten the wingnut at the rear of the P550 hand tight to prevent the controller rotating during use.

### 4.4.2 Power

The C550c controller has an internal Lithium-ion battery. A fully charged battery will power the controller for around 4 to 6 hours.

- To charge the battery, see [page 87](#).
- To power on the controller, see [page 93](#).

### 4.4.3 Internal storage

The controller has 128GB of internal solid state storage to store survey data (video recordings, photos, and reports). As a rough guide, the storage capacity is enough for 90 hours of video footage.

You can export stored survey data from the controller to a USB memory stick, as email attachments, or as uploads to a Dropbox account.

**Caution:** *The controller uses an SD card for storage. Do not remove or replace the SD card! Only CUES technical staff can do this.*

#### 4.4.4 USB memory stick

You *must* use a USB memory stick (not supplied) to install software upgrades. You can *optionally* use a USB memory stick to import your company logo onto the controller and to export surveys and other data. The controller only supports FAT32 memory sticks; see [page 125](#).

You can use any USB port on the front or rear of the controller; see [pages 27 and 29](#).

#### 4.4.5 Keyboard

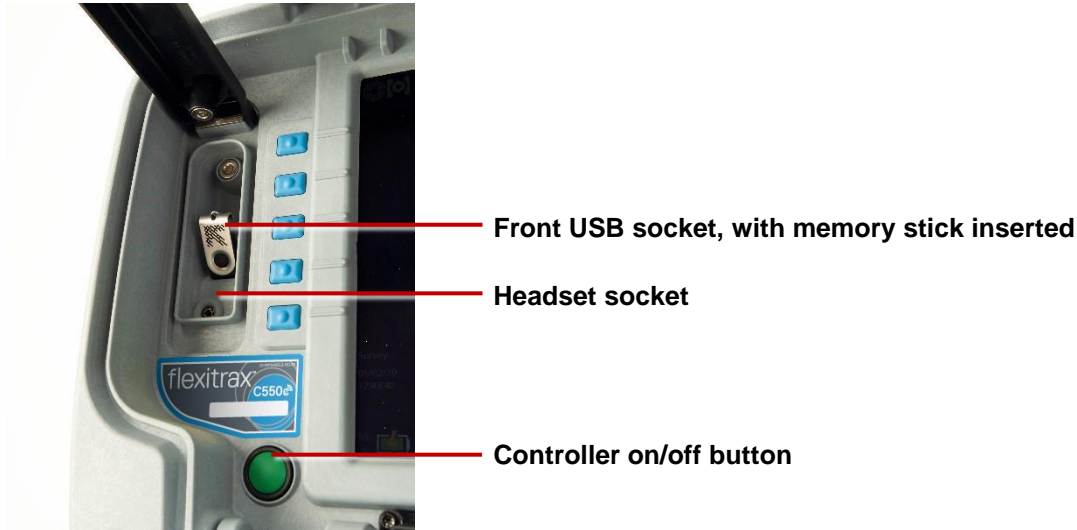
Your C550c controller is supplied with the correct keyboard for your region and the controller settings are preconfigured to use this keyboard layout. However, you can manually specify a different keyboard layout if required. For example, you can select a US English, French or German keyboard layout; see [page 104](#).

*(Optional)* Where operating conditions permit, you can connect an external keyboard to a USB port on the auxiliary connection panel; see [page 32](#).

**Note:** *The controller does not support a mouse.*

#### 4.4.6 Headset

*(Optional)* You can use a headset with a microphone to record and hear audio commentary in your video recordings. Connect the headset to the protected audio socket on the front of the controller.



*Fig. 4.21: C550c on/off button and front connections, showing headset socket and installed USB memory stick*

## 4.5 Pushrod reels

The C550c crawler inspection system can also be used with pushrods. Connect your pushrod directly to the labeled connector on the Powered Drum or manual Drum PSU.

**Note:** Whenever you connect new equipment to the C550c controller, enter the information into the *Equipment* menu within *Settings*, see [page 110](#).



Pushrod link lead socket

*Fig. 4.22: C550c pushrod link lead socket*

On the reel, find the link cable socket on the side of the reel ([page 45](#)).





*Fig. 4.23: Link cable (1) connects to the pushrod reel (2)*

Tighten the connectors finger-tight but do not use a wrench, spanner or pliers.

**Note:** You must select the reel type when you power on the controller; see [page 110](#).

## 4.6 Cameras and accessories

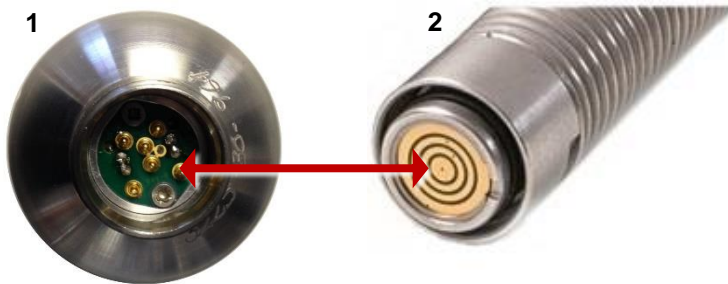


**Warning!** *When you attach or change the camera, universal flexi or sonde, the internal electrical connectors are exposed to the elements. Always attach the cameras and accessories in a dry, clean environment.*

### 4.6.1 Camera

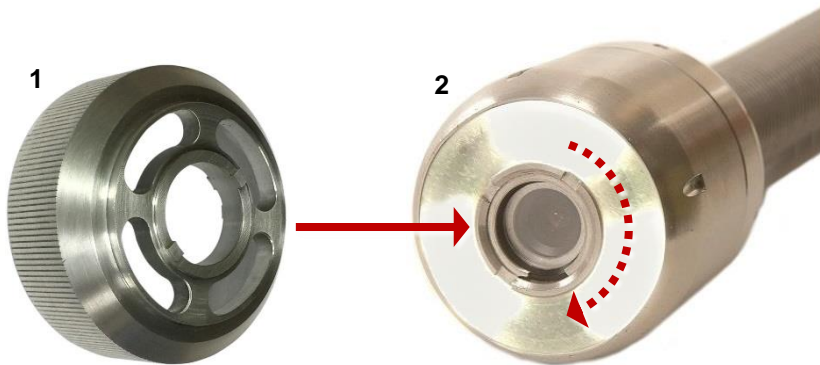
Attach the camera to the pushrod. Then focus the camera to match the pipe diameter:

- 1 Check the camera lens. Make sure there is no dirt in the lens recess. Then clean the lens with a lint-free cloth.
- 2 Fit and hand-tighten the camera to the rod termination socket.



*Fig. 4.24: Camera connector (1) attaches to the rod termination socket (2)*

- 3 (1" and 2" cameras only) For optimal image quality, adjust the camera focus to match the internal diameter of the pipe:
- Power on the rod and make sure camera's view is displayed on the controller screen.
  - Position the camera at the required distance from a suitable target object (see Table 4.1 on [page 80](#)).
  - Use the camera's focus tool (supplied with the system) to turn the focusing ring until the target object is in focus on the controller screen.



*Fig. 4.25 Camera focus tool. Attach the focus tool (1) to the camera's focusing ring (2) and rotate to adjust the camera focus.*

Camera	Internal pipe diameter		Target object: Required distance from camera	
	Inches	mm	Inches	mm
<b>1" (25mm) Camera</b>	1.25	32	3.0	76
	1.5	38	3.6	92
	2	51	4.8	122
	3	76	7.2	183
	4	102	9.6	244
<b>2" (50mm) Camera</b>	2	51	5.6	142
	3	76	8.4	213
	4	102	11.2	284
	6	152	16.8	427
	8	203	22.4	569
	9	229	25.2	640

**Note:** The 1¼" (32mm) camera has fixed (non-adjustable) focus.

*Table 4.1: Focusing table for 1" and 2" cameras*

## 4.6.2 Sondes

(Optional) Attach a sonde to the camera. A sonde is a self-contained transmitter for tracing the paths of pipes, sewers, ducts and drains.

By attaching a CUES flexisonde (or solid sonde) to your camera and using a CUES locator such as a CUES Accupoint or a Radiodetection RD5100S or RD7100DL, you can locate and track the camera as it navigates a pipe.

- **Flexisonde:** This sonde (built-in on 541c Plumbers reels) fits between the pushrod and the camera, allowing the system to better negotiate bends in the pipe.
- **Solid sonde:** This sonde adds extra rigidity to the camera and it is ideal for 'long push' inspections. A solid sonde can be used in conjunction with a *universal flexi*; see below.

**Note:** *The sonde fits on the pushrod between the rod termination socket and the camera.*



*Fig. 4.26: Flexisondes (1) and solid sonde (2)*

### 4.6.3 Universal flexi

*(Optional)* Attach a universal flexi to the camera. This is a flexible spring attachment that allows the camera and pushrod to negotiate sharp bends in the pipe. The universal flexi fits on the pushrod between the rod termination socket and the camera.

**Note:** *The universal flexi is not required for the Plumbers system.*



*Fig. 4.27: Universal flexi*

#### 4.6.4 Skids

Attach appropriate skids to center the camera and protect it from damage.

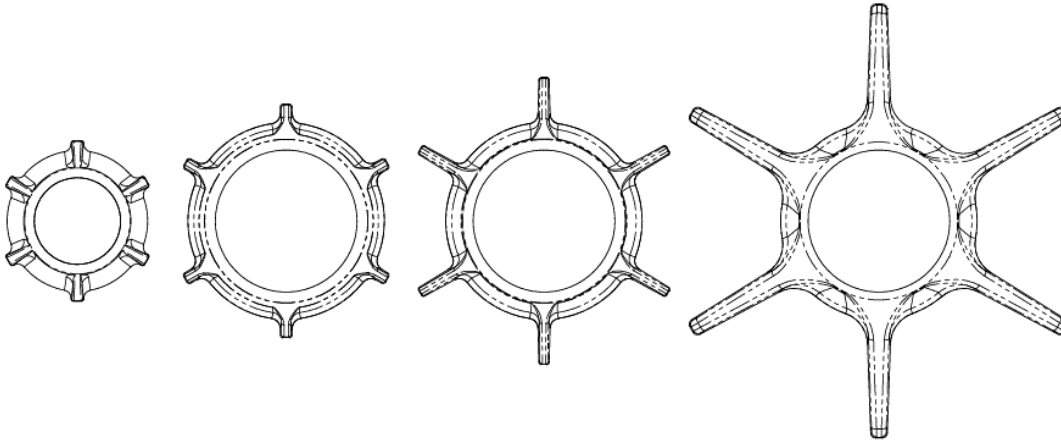
Skids protect the camera from damage and allow it to safely navigate larger pipes. Use skids with the camera wherever possible.

You can also attach skids to ensure the axis of the camera is aligned with the central axis of the pipe. (If the camera is not centered in the pipe, videos and photos can be distorted. This can potentially cause errors when estimating water levels and the location of pipe deformations.)

Each pushrod system comes with a universal skid set that allows you to adapt your camera and pushrod for deployment in pipes from 2" (50mm) to 6" (150mm). The skid set works with 1" (25mm) and 2" (50mm) cameras and the solid sonde, the 1" (25mm) and 1.4" (35mm) flexisondes, and the universal flexi. The W-skid can be used with the 2" (50mm) camera for pipe diameters up to 9" (225mm).

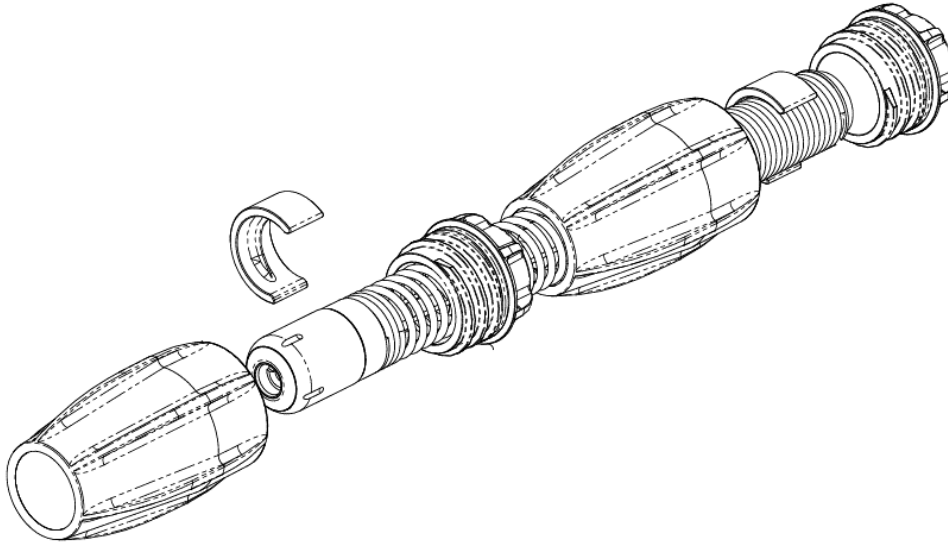
The diagram on [page 85](#) shows the different diameter configurations that can be achieved with the universal skid set. The subsequent pages show how the 1" (25mm) and 2" (50mm) cameras

**Note:** *CUES recommends using two skids to help keep the camera level.*

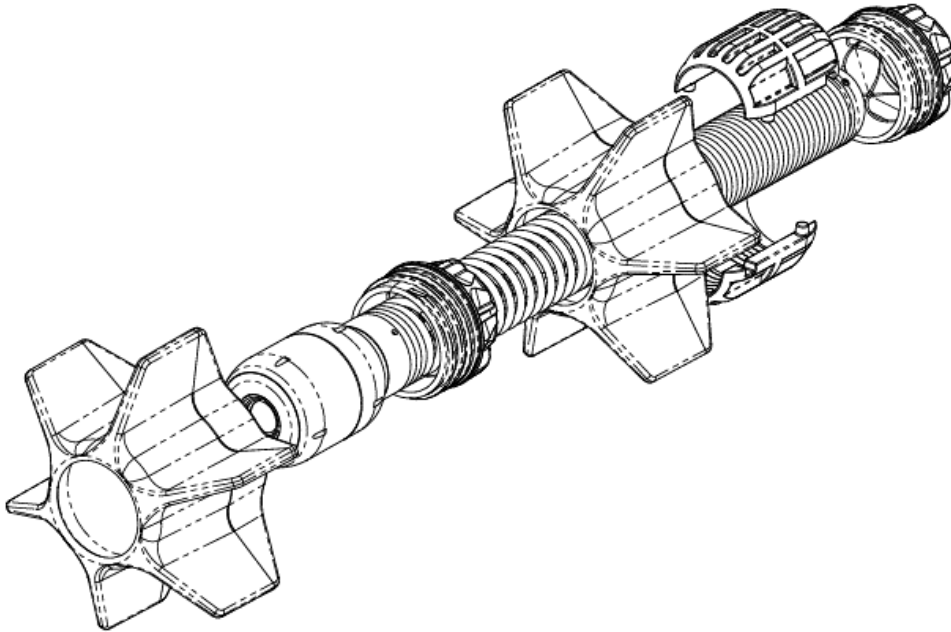


*Fig. 4.28: Different diameter configurations that can be achieved using the universal skid set*





*Fig. 4.29: Universal skid set for 1" (25mm) camera and flexisonde*



*Fig. 4.30: Universal skid set for 2" (50mm) camera and 1.4" (36mm) flexisonde*

### 4.6.5 W-Skids

*(Optional)* Use the 8" (200mm) W-Skids to center a 2" (50mm) camera in an 8" (200mm) pipe or to help center the camera in larger pipes. To install the W-Skids:

- 1 Position each of the three W-Skids onto the collar and fix firmly with two M5 x 12mm screws each. The skids are asymmetrical and can only be fitted one way round.
- 2 Loosen the two M6 x 20mm screws that hold the two halves of the collar together and insert the flexisonde with the camera attached into the collar.
- 3 Make sure the camera is touching the screw end of the collar. Then tighten the two M6 x 20mm screws evenly and firmly to re-tighten the collar.

## 4.7 Battery

The C550c controller has an internal lithium-ion (Li-ion) battery.

You must fully charge the battery before using the system for the first time. You can also power the controller from a 12-24V DC vehicle supply.

A fully charged battery will power the controller for around 4 to 6 hours. The actual battery life will depend on usage and system configuration. For example, if screen brightness is set to maximum and WiFi is permanently enabled, the battery will drain faster.

For charging the battery and replacing the battery at the end of its useful life, see [pages 89 to 92](#).



For advice on prolonging the battery life, see [page 36](#).

### 4.7.1 Charge the battery before using the controller



**Warning!** Use only the supplied battery charger (or optional vehicle charge lead). Do not plug any other CUES connectors into the controller power socket.

You must fully charge the controller's internal battery before using the system for the first time. To charge the battery:

- 1 Use the supplied mains adapter ('power brick') to connect the controller to the mains power supply. The controller's power socket is on the main connection panel on the rear of the controller.
- 2 Allow 4 to 6 hours for the battery to be fully charged. While charging is underway, the  battery charge LED on the controller's handle is amber (page 30).
- 3 When the battery is fully charged, the  battery charge LED is green and the battery indicator on the home screen (page 34) is also solid green.



Power socket

Fig. 4.31: Power socket (1) on main connection panel

## 4.7.2 If the battery has low charge

**Caution:** *We recommend you use an alternative power source when the battery charge is low to avoid losing survey data. A low battery may also cause the power to cycle repeatedly.*

The current battery charge is always shown on screen. For example, see the home screen on [page 34](#). You also can check the battery level at any time by pressing the **Battery check** button ([page 30](#)).

If the battery charge is low, you can:

- Adjust the Power Management settings. For example, you can set timeouts to automatically dim the screen or power off the pushrod after a period of inactivity. See [page 124](#).
- Adjust key settings to reduce battery usage. For example, if screen brightness is set to maximum and WiFi is permanently enabled, the battery will drain faster
- Connect the supplied battery charger (or optional vehicle charge lead); see [page 90](#).

### 4.7.3 Power the controller from a vehicle



**Warning!** *Use only the supplied vehicle charging cable. Do not plug any other automotive chargers into the controller power socket.*

If the controller has low battery charge, you can still operate it while powering it from your vehicle. The vehicle charging cable is 18ft (5.5m), but if the survey site prevents you parking the vehicle close to the manhole or pipe that you need to survey, you can recharge the controller battery from your vehicle.

Use the supplied vehicle charging cable to connect the controller to your vehicle's DC power connector (typically the cigarette lighter or cigarette charging point). The controller's power socket is on the main connection panel on the rear of the controller; see [page 89](#).

### 4.7.4 How long does it take to recharge the battery from my vehicle?

This depends on several factors, including whether the controller is powered on and the condition of your vehicle battery. Also, some vehicles switch off the DC power connector while the ignition is off.

But as a rough guide, if the controller is powered off, then 60 minutes of recharging from your vehicle's DC power connector (for example, while driving to the survey site or during a lunchbreak) can restore the controller battery level by up to 25%.

Consider also the power management options to preserve battery life; see [page 90](#).

### 4.7.5 Replacing the battery



*Do not attempt to replace the battery yourself!*

With typical constant usage, the controller battery will last around two years. If the battery reaches the end of its useful life and you can no longer recharge it, the battery must be replaced by CUES technical support; see [page 23](#). Or contact your CUES representative.




## 5 System setup

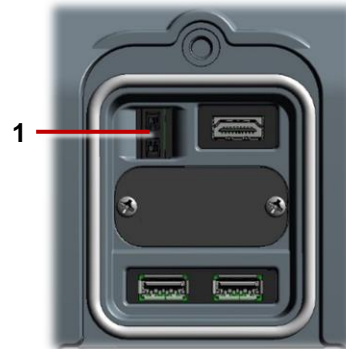
When you power on the controller for the first time, you must carry out various setup tasks. Make sure you complete these tasks before you start any pipeline surveys.

### 5.1 Insert the fuse

A 5A 32V MINI blade fuse is supplied separately with the controller. You must insert the fuse before powering on the controller for the first time.

Open the cover of the auxiliary connection panel and insert the fuse into the fuse holder. Then close the cover.

 **Warning!** *You must remove the fuse to isolate the battery when the controller is transported by air!*



*Fig. 5.1: Fuse holder (1) in auxiliary connection panel.*

## 5.2 Power on the controller



**Warning!** *The controller is not earthed. If system connects to any mains operated equipment, the external equipment **must** be earthed in accordance with the manufacturer's instructions. Failure to earth the attached equipment may result in potentially lethal electric shock.*

To power on the controller:

- 1 Open the two covers.
- 2 Press the power button to switch on the controller ([page 27](#)).

The  power LED on the handle is green when the controller is powered on.

- 3 The controller takes around 10 seconds to display the first screen:
  - When you power on the controller for the first time, the setup wizard launches; continue to [page 95](#).
  - When you power on the controller on all subsequent occasions, the controller first prompts you to calibrate the reel; continue to [page 99](#).

## 5.3 Setup wizard: Set controller preferences and company details

When you power on the controller for the first time, or after performing a factory reset (see section 10.3), a setup wizard launches automatically. The wizard comprises several menus where you can set preferences and company details.

Follow these steps:

- 1 Power on the controller for the first time.

The setup wizard launches automatically.

- 2 Select the controller language.

- 3 Select the **Continue** menu item to display the next setup wizard menu.

(Use the **Up** and **Down** buttons or press the  $\uparrow\downarrow$  arrow keys to select menu items.)



Fig. 5.2 Basic Configuration: Language. 1 Continue menu item.

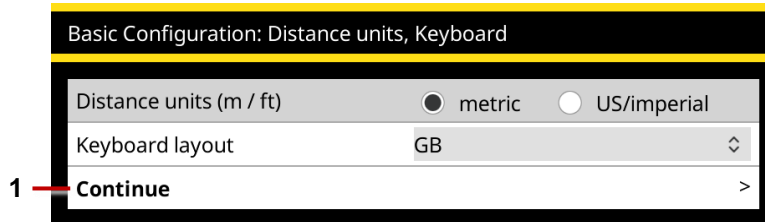
- 4 Select the controller date and time, date format and time zone. Then select the **Continue** menu item. The date and time are shown on the controller screen and, optionally, overlaid on video recordings; see [page 106](#).

**Note:** You will need to manually adjust the controller's time to account for daylight saving time (DST) clock shifts in your area.



*Fig. 5.3 Basic Configuration: Date and time. 1 Continue menu item.*

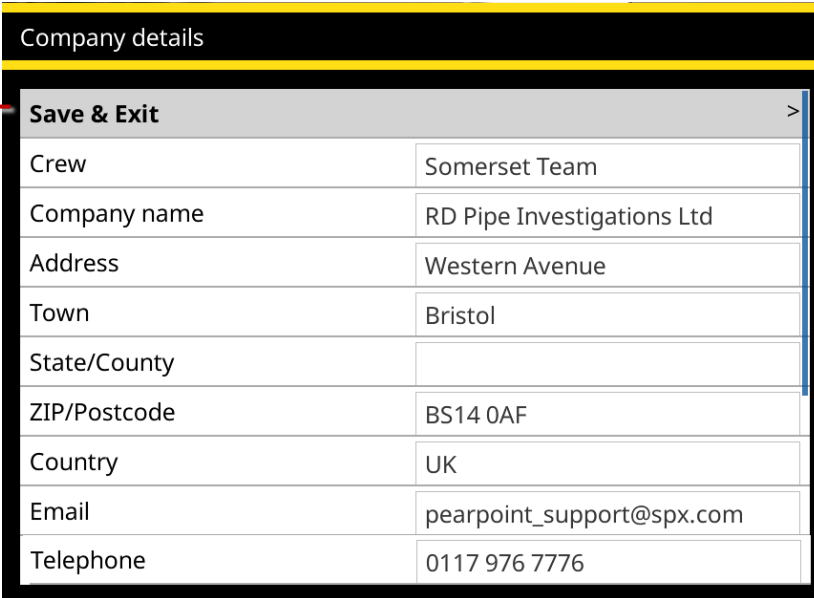
- 5 Select your keyboard layout and distance units (0.0m or 0.0ft). Then select the **Continue** menu item. The camera distance is shown on the controller screen and, optionally, overlaid on video recordings; see [page 106](#). Your chosen distance units are also used when adding survey observations.



*Fig. 5.4 Basic Configuration: Distance units and keyboard. 1 Continue menu item.*

- 6 Enter your company details. Then select the **Save & Exit** menu item to quit the setup wizard.

The controller will use these details to personalize the title page of your survey reports. You can also import an image of your company logo, though you may prefer to do this later; see [page 128](#).



Company details

1 **Save & Exit** >

Crew	Somerset Team
Company name	RD Pipe Investigations Ltd
Address	Western Avenue
Town	Bristol
State/County	
ZIP/Postcode	BS14 0AF
Country	UK
Email	pearpoint_support@spx.com
Telephone	0117 976 7776

*Fig. 5.5 Basic Configuration: Company details. 1 Save & Exit menu item.*

- 7 The controller now prompts you to select the reel type and calibrate the reel; continue to [page 99](#).

## 5.4 Calibrate the equipment


Every time you power up the controller, you will need to confirm what equipment is connected to the C550c controller.

Briefly, after the setup wizard is complete, in the Equipment settings menu, select the drum type, crawler, crawler wheel size, camera type and other equipment that is currently attached to the controller. Then select the **Continue** menu item.

You will then continue to the controller home screen.

If you have a pushrod connected you will be advised to rewind the pushrod fully onto the reel (coiler). Make sure the pushrod is layered evenly and correctly onto the reel and the end of the rod is level with the rod guide.

Press the Calibrate button to calibrate the reel.

After calibrating the reel, press the  **Back** button or Esc key to return to the controller home screen. You can now use the Settings menus to configure the system; continue to [page 101](#).

**Note:** For definitions of calibration and zero distance, see [page 22](#).

## 5.5 Status icons

The home screen displays status icons in the top left hand corner, referring to the drum and either the crawler or pushrod that is connected. The different icons displayed, and what they represent, are:



P550 drum



Crawler



Pushrod

In normal operation the drum and crawler icons are green and the pushrod is white. See [page 255](#) for what other colors signify.



## 5.6 Configure the system settings






Use the Settings menus to configure the system before you start any pipeline surveys. For example, you can set the locale, date and time. You can specify where the date & time and camera distance are shown on the screen. You can also add your company details (these details are included in your survey reports).

From the main Settings menu, you can access:

- **Controller settings:** see [page 104](#).
- **Screen overlay settings:** see [page 106](#).
- **Equipment settings:** see [page 110](#).
- **Reporting settings:** see [page 111](#)
- **Network settings:** see [page 113](#).
- **Email settings:** see [page 120](#).
- **Dropbox settings:** see [page 121](#).
- **Maintenance settings:** see [page 124](#).
- **Company details:** see [page 127](#).

### 5.6.1 Using the Settings menu

Use the buttons and keyboard to navigate the menus. See Fig. 5.6 on [page 103](#).

- **Access the Settings menu:** Go to the home screen and press the  **Settings** button ([page 34](#)).  
(If necessary, press the  **Back** button to go back to the home screen.)
- **Navigate the menus:** Do the following:
  - To browse items in a menu, use the **Up** and **Down** buttons or the   arrow keys.
  - To go back to the previous menu or screen, press the  **Back** button or the Esc key.
- **Select and edit a setting:** Press the **Select** button or the Enter key.

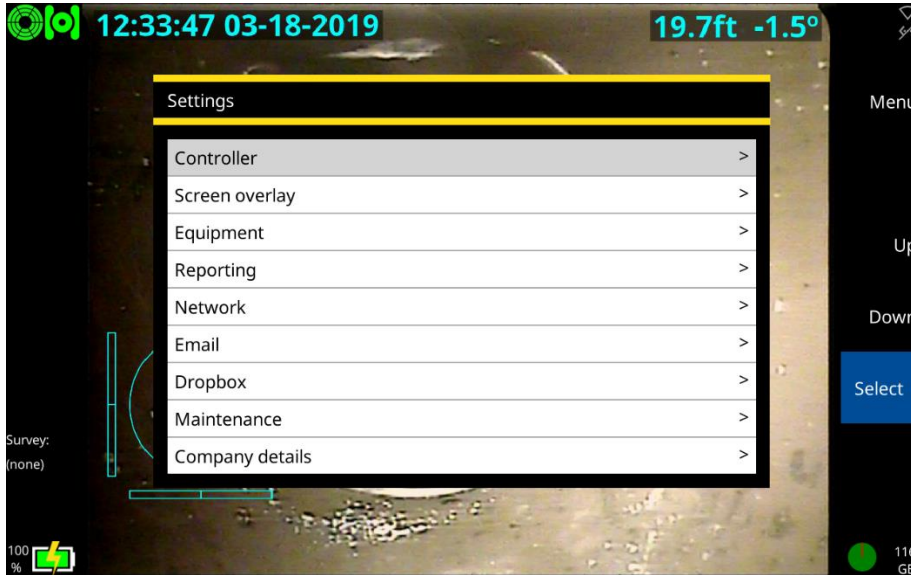


Fig. 5.6: Settings menu.

## 5.6.2 Controller settings

Use this menu to configure general controller settings.

- **Screen brightness:** You can adjust the screen brightness to suit the current lighting conditions. Select the setting. Then use the **Up** and **Down** buttons to adjust the brightness. Or you can use the  $\uparrow$   $\downarrow$  arrow keys.

**Note:** *If the battery level is low on your controller, reduce the brightness to save battery power.*

- **Menu scrolling wraps around:** When enabled, this setting allows you to loop through all items in a menu using only the **Up** button, or only the **Down** button. For example, when you get to the bottom of menu, pressing the **Down** button will loop the cursor back to the top of the menu.
- **Language, distance units, keyboard layout:** You can set up the controller for your locale. For example, you can set the language for menus and buttons on the controller screen and you can show distance measurements in meters or feet (ie, metric or imperial).

If required, you can specify a different keyboard layout. Supported layouts include US, UK, German (QWERTZ) and French (AZERTY).

- **Date and time:** To ensure that your reports, videos and photos are correctly timestamped, you can set your time zone, your preferred date format (for example, DD/MM/YYYY or MM/DD/YYYY), and the current date and time.

**Note:** *The controller remembers the date, time and time zone, even if its battery is fully discharged. You will not need to re-enter these details after setting up the controller for the first time.*

- **Video source:** By default, the controller displays video input from the pushrod camera. But if required, you can connect an external camera to the controller and display video
  - **Camera:** This option displays video input from the pushrod camera.
  - **Auxiliary:** This option displays video input from an external camera. You must connect the external camera to the controller's RCA video jack ([page 31](#)).
  
- **Keyboard shortcuts:** When enabled, this setting allows the use of predefined shortcuts as an alternative for Joysticks and buttons to control the movement of the crawler, powered drum and camera.
  - **Crawler:** Use the ←→↑↓ arrow keys on the keyboard to drive the crawler and powered drum.
  - **Camera:** Use W; A; S; D to control Pan and Tilt of the PT and PTZ cameras. Use J for Joint scan and C to center the camera.
  - **Mimic hide/ show:** Use M to toggle the Mimic OSD which indicates crawler speed, steering angle and camera position.
  - **Stop:** You can stop the drive system, including the crawler, powered drum and powered elevator by pressing the Spacebar.

### 5.6.3 Screen overlay settings

Use this menu to configure how the date & time and pushrod distance are shown on the screen and overlaid on video recordings and photos.

- **All hide/show:** This setting displays or hides the date & time and rod distance.  
When this setting is enabled, this information is shown on the controller screen and on your survey videos and photos. If this setting is disabled, this information is hidden.
- **Date & time hide/show:** This setting displays or hides the date & time
- **Distance hide/show:** This setting displays or hides the pushrod distance i.e, how far the rod is unwound from the reel.
- **Pitch hide/show:** This setting displays or hides the crawler pitch.
- **Mimic hide/show:** This setting displays or hides the Mimic OSD which indicates crawler speed and steering angle, and the camera position.
- **Mimic size:** Choose between Normal and Small.
- **Mimic location:** This setting sets the position of the Mimic on your display.

- **Layout choice:** Choose where on the screen to display the date & time and crawler distance & attitude. You can display this information at the top, bottom or center of the screen, or on the left or right.



*All hidden*



*Top*



*Bottom*



*Middle*



*Left*





*Right*

*Fig. 5.7: Screen information layout options*

- **Text background opacity:** By default, text overlaid on the screen has a semi-opaque background to make it easier to read. But you can adjust the opacity (0% to 100%) to suit video recording conditions. For example:

0% opacity: 

50% opacity: 

100% opacity: 

**Note:** *You cannot change the background opacity in a video after it has been recorded.*

- **Text color:** Choose the color of the overlaid text.
- **Video title page:** You can add a title page to the start of your survey videos.
  - **Title page duration:** Specify how long (in seconds) the title page is displayed when a video starts. This setting applies to all videos saved on your controller.
  - **Enable video title page:** This setting enables or disables the title page for all survey videos recorded *subsequently* on your controller.

If the title page is enabled, it is attached to all videos recorded subsequently. Conversely, videos recorded while the title page is disabled will not have a title page and *will not gain one if you subsequently enable the title page.*



You must *set up* a video title page before you enable it. To set up a title page, see [page 129](#).

- **Observation text overlay:** You can choose for observations to be overlaid as text on the recorded video.
  - **Show observation text on video:** Specify whether to show observations
  - **Observation text duration:** Specify how long (in seconds) each observation is displayed.

### 5.6.4 Equipment settings

This menu is shown automatically when you power up a system (see [page 135](#)) except for the first time when the Set-up Wizard is shown (see [page 94](#)).

**Note:** *If the Equipment versions item shows in red, the C550c controller has a newer version of software for one of system components than is currently installed on that component.*

- **Drum type:** If the drum is powered up, the C550c controller will automatically display whether you have a powered or manual drum connected.
- **Tractor type:** If the drum is switched on and power is reaching the tractor, the C550c controller will automatically display whether you have a steerable or non-steerable tractor connected.
- **Tractor wheel size:** Enter the wheel size correctly to ensure that distances are measured correctly.

**Caution:** *Setting the wrong wheels will affect drum speed when retrieving and may cause the crawler to topple. Additional wear and tear may also be caused to drum, tractor, or both.*

- **Camera type:** If the drum is switched on and power is reaching the camera, the C550c controller will automatically display the camera type connected.
- **Powered elevator:** If the drum is switched on and power is reaching the tractor, the C550c controller will automatically display whether you have a powered elevator connected.
- **Lighthead:** If the drum is switched on and power is reaching the camera, the C550c controller will automatically display whether a lighthead is detected or not.

- **Sonde frequency:** Your tractor includes an on-board sonde. Use this menu to select the frequency that the sonde transmits or to turn the sonde off. You can also use the panel button to cycle through the sonde frequencies, see [page 148](#).
- **Reel type:** Select the reel type you are using from the dropdown list.

It is essential that you select the correct reel, for best video quality and accurate distance measurements. If you select the wrong reel, pushrod distance measurements will be inaccurate and your survey may be unusable.
- **Reel power off/on:** Use this setting to turn the reel camera off or on.

**Note:** *If the battery level is low on your controller, turn off the camera to save battery power.*

### 5.6.5 Reporting settings

The C550c can help you create reports which conform exactly to the reporting standard you chose when creating a survey.

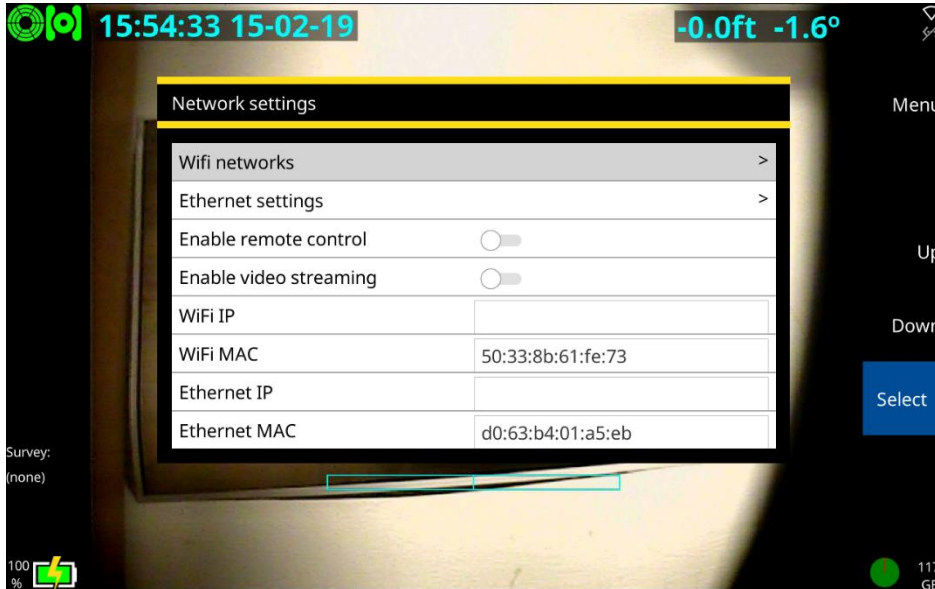
- **Enforce mandatory fields:** When you select this option the C550c will report an error if you leave a mandatory field blank. (Correct the error so that you can continue.)
- **Validate format of entered data:** When you select this option, the C550c will report an error if you fill in a field in the incorrect format. (Correct the error so that you can continue.)

Select both options when you must create reports strictly complying with a given standard, Turn off one or both options when you would like the increased flexibility for entering freeform text.

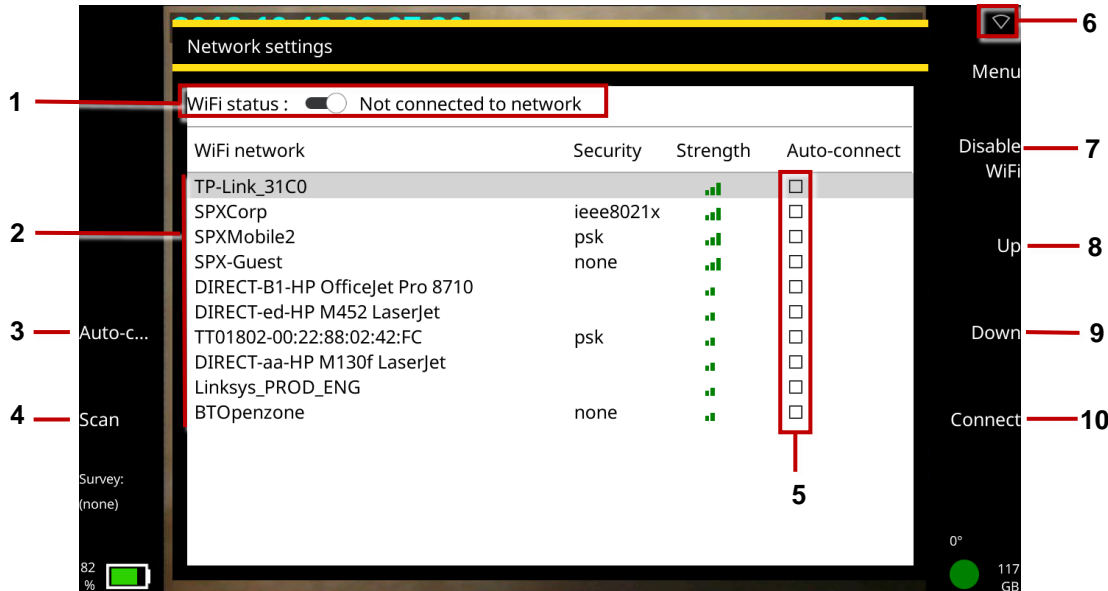
- **Enter/Return key moves to next line:** Enabling this allows to use the Enter/Return key to move to the next line within the survey header, see [page 203](#).

### 5.6.6 Network settings

Use this screen to set how the controller connects via WiFi and Ethernet.



**WiFi networks:** Use this screen to connect the controller to the internet over a WiFi network. You will need an internet connection to send survey reports by email or upload them to Dropbox.



*Fig. 5.8: Network settings. 1 WiFi status. 2 Network list. 3 Auto-Connect button. 4 Scan button. 5 Auto-Connect check boxes. 6 WiFi icon. 7 Enable/Disable WiFi button. 8 Up button. 9 Down button. 10 Connect button*

- WiFi status: Shows WiFi status, which may be:
  - Disabled
  - Not connected to network (but enabled)
  - Connected
- **WiFi icon:** Shows which WiFi network the controller is currently connected to. If the WiFi network has internet access, “**(online)**” is appended to the network name.

The connection status is also shown by icon (item 3 on [page 114](#)):



Not connected to a WiFi network



Connected to a WiFi network, but no internet connection






Connected to a WiFi network with an internet connection

- **Enable WiFi/Disable WiFi:** When you enable WiFi, the controller automatically scans for available networks (*APs* or *access points*). For each network, you can see its name (or SSID), security protocol (if secure) and signal strength.

**Note:** *If your current location is not within range of a fixed WiFi network, you can enable a personal hotspot on your cell phone. This allows other devices, including the C550c controller, to share your phone’s data connection. (This method is also called data tethering.)*

**Note:** *If the battery level is low on your controller, disable WiFi to save battery power. When WiFi is enabled, a **Disable WiFi** button is shown on this screen.*

- **Network list:** Any available WiFi networks are listed on this screen. For each network, you can see its name (or SSID), security protocol (if secure) and signal strength.
- **Connect:** Use the Up/Down buttons or the   arrow keys to select the network you want. Then press the **Connect** button. Wait while the controller connects to the selected network. (While the controller is connected to a network, the Connect button is replaced by a **Disconnect** button.)

If you choose a secure network, the controller prompts you for the network password. The password is case-sensitive, and so be careful check whether Caps Lock is on, indicated by the  icon in the lower left corner of the screen. By default, password characters are obscured but you can click the **Show password** button to display the actual characters.





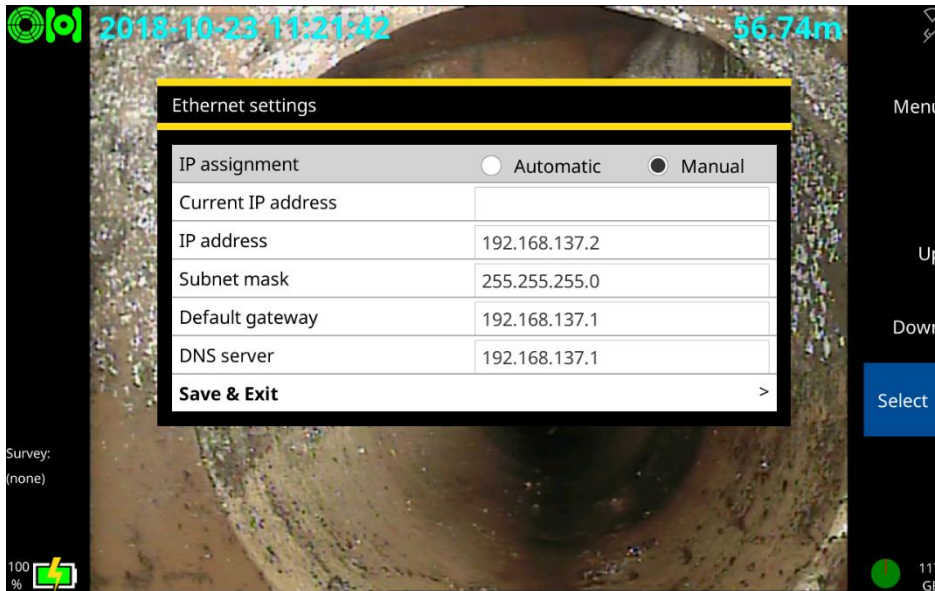
*Fig. 5.9: Set password dialog. This dialog displays when you connect to a secure WiFi network for the first time. 1 Show Password button.*

- **Auto-connect:** Use the  $\uparrow\downarrow$  arrow keys to select a network. Then press the **Auto-connect** button to select the network's check box. In future sessions, the controller will automatically re-connect to this network whenever WiFi is enabled.

To disable auto-connecting, press the **Auto-connect** button again to clear the network's check box.

- **Scan:** The controller automatically scans for available networks each time you enable WiFi. But you can press the **Scan** button to manually refresh the network list.

**Ethernet settings:** Use this screen to set whether the controller's IP assignment is automatic or set manually, and what the IP address, Subnet mask, Default gateway and DNS server addresses are.



You may need these settings during remote control operations, where a van-mounted PC, for example, is used to control the inspection equipment.

**Enable remote control:** When you enable remote control, the controller allows a PC connected to it by Ethernet to take control of the crawler, camera and other inspection equipment.

**Enable video streaming:** Enable this setting to allow the controller's video/images to stream to a nearby device, such as a cell phone or tablet.

## 5.6.7 Email settings

Use this screen to set up a connection to an email server. You will need to do this if you want to send survey reports by email. You will also need to set up a WiFi connection to the internet; see [page 113](#).

- **User Email:** Enter the email address for the account you want to use when sending emails from the controller. The controller will use this account to connect to the email server.  
*Note: You will select the email recipient when you send a survey report.*
- **Password:** Enter the password for the account you will use to send emails from the controller.
- **Username:** If required, enter the SMTP Username for the account you want to use when sending emails from the controller.  
*Note: Some email services, including Gmail, will use the SMTP Username attribute as the sender's address instead of the supplied User Email address.*
- **Server:** Enter (or select) the email server you want to use.  
If the controller detects a recognized email account type (eg, Outlook or Gmail), it automatically sets the appropriate email server (smtp-mail.outlook.com or smtp.gmail.com).
- **Port:** If using an SMTP connection, you must enter the TCP port for email submission on your SMTP server. The default is port 587.
- **Requires secure connection (TLS):** By default, the controller always sends emails over a secure (encrypted) connection ie, over an SMTPS connection. But you can clear this check box if it is acceptable to send survey reports over an unencrypted connection

### 5.6.8 Dropbox Settings

Use this screen to set up a connection to a Dropbox account. You will need a Dropbox connection if you want to upload survey reports to the cloud.

Before you use this feature, you must have a Dropbox account and the controller must be connected to the internet.

To set up a Dropbox connection:

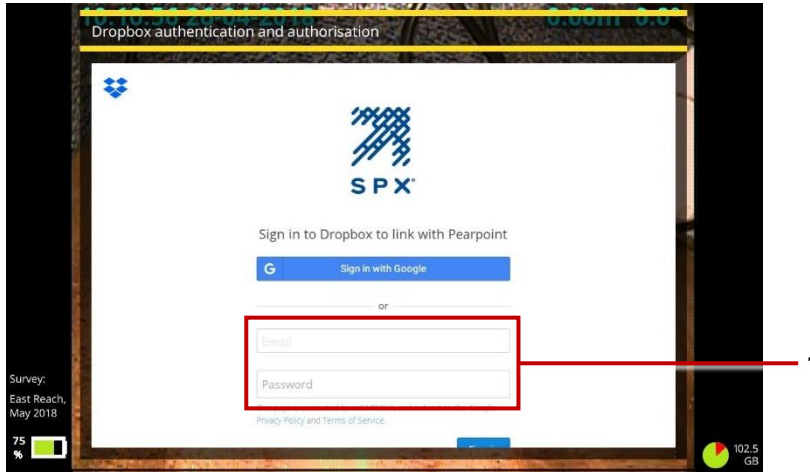
- 1 Select Connect to Dropbox from the Dropbox settings menu
- 2 Confirm that the controller has an internet connection; see [page 113](#).
- 3 From the Dropbox Settings menu, select **Connect to Dropbox**.

This will launch a conventional Dropbox Login screen sequence.

*Instructions continue on next page.*

- 4 In the **Dropbox authentication and authorization** screens, enter the email address and password for a valid Dropbox account using the keyboard **Tab** key to navigate from one box to the next.

**Note:** *We recommend that you do not use your personal Dropbox account. Instead, use a company account or a custom account specifically for storing survey reports.*

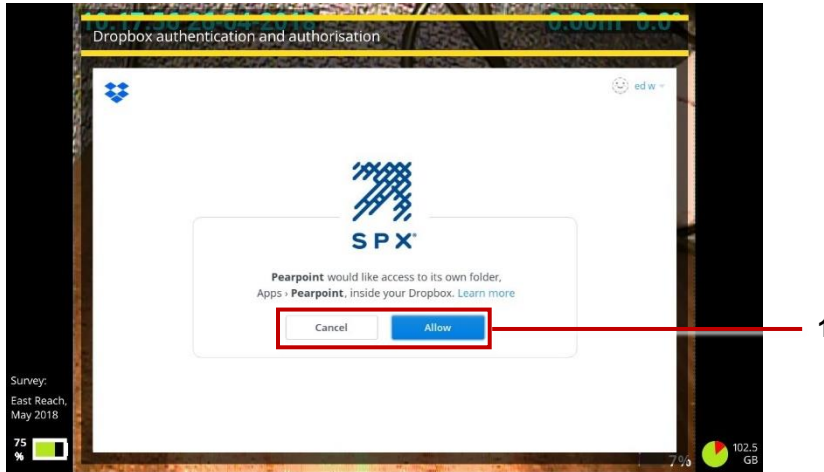


*Fig. 5.10: Dropbox login screen. 1 Email address and password.*

- 5 If prompted, follow the instructions on the reCAPTCHA verification screen. Use the keyboard **tab** key to navigate to the text input boxes.

**Note:** *reCAPTCHA is a Google spam prevention test designed to confirm that a computer user is human and not a bot.*

- When prompted, allow CUES to create a subfolder inside your Dropbox folder tree; see [page 221](#) for details about the target subfolder.



*Fig. 5.11: CUES access request. 1 Cancel and Allow buttons.*

To sign out of Dropbox: Select **Sign out** from the Dropbox settings menu.

## 5.6.9 Maintenance

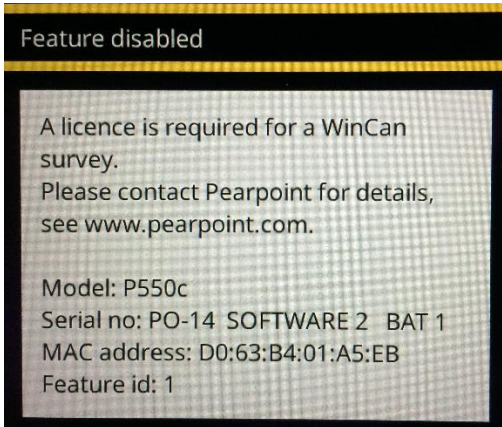
Use this screen to set power management options, update the controller software, for diagnostic tasks, and reformat your USB memory stick to FAT32.

- **Power management:** Use these settings to reduce power consumption and prolong battery life. For each setting, you define an 'idle controller' timeout. This timeout refers to a period, in minutes, when there is no interaction with the controller keyboard or buttons.
  - **Dim screen after idle (minutes):** Screen brightness is a major drain on battery charge. This setting automatically dims the screen after a period of inactivity. Set a timeout (in minutes) for dimming the screen. If the controller keyboard or buttons are not used before the timeout expires, screen brightness is reduced to its lowest level.
  - **Shutdown after idle (minutes):** This setting automatically powers down the controller after a period of inactivity. Set a timeout (in minutes) for powering down the controller. If the controller keyboard or buttons are not used before the timeout expires, the controller powers down.
  - **Rod power off after idle (minutes):** The pushrod camera has a major effect on power consumption. This setting automatically powers down the camera after a period of inactivity. Set a timeout (in minutes) for powering off the camera. If you do not use the controller keyboard or buttons before the timeout expires, the camera powers down.



- **Software update:** Use this setting to install software updates from a USB memory stick. For details, see [page 261](#).
- **Software versions:** Lists the installed versions of various firmware and software components. This information may be needed by CUES support staff for diagnostic purposes.
- **Equipment logs:** If any errors have occurred with parts of the system, the C550c controller will log the issues here.
- **System info:** Lists Serial number(s), IP addresses and MAC addresses.
- **Application debug log:** Use this setting to view and export log files. These logs are used by CUES support staff to diagnose controller issues.
- **Diagnostics:** This screen displays status data for various system components. This data can be used by CUES support staff to diagnose controller issues.
- **Format USB disk:** Use this setting to reformat your USB memory stick to FAT32. .  
The controller does not support USB memory sticks that have an NTFS file system. If your USB memory stick uses NTFS, you will need to reformat it before you can export your surveys to the memory stick.  
**Caution:** *Reformatting your USB memory stick will erase any files currently saved on the stick.*
- **Factory reset:** Resets your controller to its factory settings.  
**Caution:** *Resetting the controller will **erase all your surveys**, also system settings, personal preferences and your company details.*

- **Feature enable menu:** Use this menu to install feature-enabling certificates such as WinCan. To add the ability to create WinCan-compliant survey reports follow these steps:
  - 1 From the home screen, press the *Create a survey* key, see [page 196](#).
  - 2 In the *Create survey* menu, navigate to *Format* and select WinCan.
  - 3 Navigate to *Continue*, and press Select. You will be shown a pop-up containing information specific to your controller.



*Fig. 5.12: Feature disabled pop-up, containing the information required to enable your controller.*

- 4 Email the Model, Serial no, MAC address and Feature id information to your local CUES representative. You can use the *Contact Us* form on the [www.pearpoint.com](http://www.pearpoint.com) website for this purpose.
- 5 You will shortly be emailed a [cert.asc](#) file. Copy this to a USB stick, which should be put into one of the USB ports on the P550 controller
- 6 Return to the Feature enable menu, navigate to *Install feature enable certificate* and press *Select*.
- 7 Navigate to the folder on the USB stick containing the [cert.asc](#) file, highlight the [cert.asc](#) file and press *Select*.

This will result in a message saying that the feature has been installed successfully, and the cert.asc file should now be listed in *Enabled features*. If this is not the case, please contact your local CUES representative.

### 5.6.10 Company details

Use this screen to enter your company details and, if required, your company logo. The controller will use these details to personalize the title page of your survey videos and reports.

After entering your company's details, you will not need to re-enter them unless you perform a factory reset; see [page 260](#).

To import a company logo, see [page 128](#).


## 5.7 Import a company logo



You can import your company logo to personalize the controller splash screen (shown briefly on startup) and the title page of exported survey reports.

Follow these steps:

- 1 Copy the logo image (PNG or JPG only) to a USB memory stick and attach the stick to the controller. You can use any of the controller's USB ports.

**Note:** *The image file must be smaller than 2MB.*

- 2 In the Home screen, press the  **Settings** button (item 6 on [page 34](#)).
- 3 Choose Settings > Company Details.
- 4 Scroll to the bottom of the Company Details menu and choose **Select company logo**.
  - a. In the Image Import screen, select the logo.

Use the   arrow keys and the Esc and Enter keys to navigate folders on the USB memory stick and select the file you want.
  - b. Press Enter or the **OK** button to import the logo.
- 5 Back in the Company Details menu, the **Company logo** is automatically set to Active.



*Fig. 5.13: Example title page for exported survey report (Microsoft Word format only). 1 Your company logo. 2 Your company name, address and phone number*

## 5.8 Set up a video title page

*(This task is optional)*

You can set up a title page for all your survey videos. If the video title page is enabled, it is attached to all videos recorded subsequently on the controller. The title page displays at the start of the videos.

The title page can include company details, including a logo or image, and survey details. Note that the survey details are taken from the *header* that you supply when you create a survey. The header refers to the basic survey details recorded on an MSCC standard coding form (date, location, surveyor and so on).

You must set up the title page *before* you record any videos. If you record a survey video before setting up a title page, the video will not gain a title page if you subsequently set up a title page.

Instructions for designing a title page are on [page 131](#).

### 5.8.1 Can I set a custom title page?

Yes. If you design the title page to include *survey text*, these text elements always reflect header details for the current survey. For example, although the same title page is used for all survey videos, you can design the title page to always show the date and location of the current survey.


If you want a completely different title page for a particular survey video, you can temporarily customize the current title page, record a new survey video, and then undo the customizations and restore the title page to its previous state.

## 5.8.2 Design the video title page

Follow these steps:


- 1 Set up a new survey (see page 107) or open a survey (see [page 201](#)).

You can only edit the title page when a survey is open.

- 2 In the *Edit Survey* screen, press the  **Title page** button.

The current title page now appears (if set up) and the buttons change to allow editing of the title page

- 3 **Add text and graphic items.** Use the following buttons to add text and graphics to the title page:

- **Add company details:** Adds an item of company information, for example, the company name or phone number. (You cannot change the company name, phone number, etc., from this menu, only decide whether or not they are displayed. To make changes, select Settings then Company details from the home menu.)
- **Add survey details:** Adds a survey header detail, for example, the survey date, location or remarks. When you record a video, the title page is populated with header details from the *current survey*. In effect, adding survey text allows you to customize the title page for each video. (To change the contents of the survey header, press the Edit survey header  button.)
- **Add text:** Adds a general text caption. This will appear in the title page for all your videos.
- **Add graphic:** Press this button to import an image file from a USB memory stick.

(First, you need to save the image to a USB memory stick and insert the memory stick into a controller USB port. Use the  $\uparrow\downarrow$  arrow keys and Enter keys to select the image you want.)

When you add a text element or graphic, it displays in the center of the screen. You can now reposition the element. You can also resize graphics.

4 **Position and edit each item.** Set up the items on the your page:

- a. Press the **Select item** button repeatedly until the item you want is highlighted in red.
- b. Use the  $\leftarrow\rightarrow\uparrow\downarrow$  arrow keys on the keyboard to position the item on the screen.
- c. *Graphics only:* Press the **Enlarge** or **Shrink** buttons to resize the item.
- d. *Text only:* Press Enter on the keyboard to edit the text. Press Enter again to save the changes.

If you need to remove an item, press the **Delete** button.

5 Press **Settings** button to enable or disable the video title page, and to set the duration (in seconds) for which the title page is displayed.


6 The title page design is saved automatically. Press Esc or the  **Back** button to quit the title page and return to the home page.

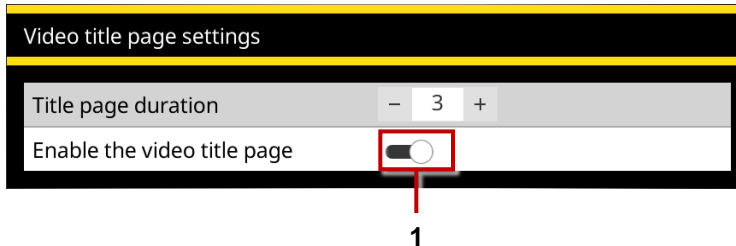
7 Now enable the video title page; see the next section.



### 5.8.3 Enable the video title page


After designing the title page, you must enable it to automatically add it to all survey videos recorded subsequently on the controller:

- 1 Make sure that you have designed the title page; see [page 131](#).
- 2 In the Home screen, press the  **Settings** button (item 6 on [page 34](#)).
- 3 Choose Settings > Screen Overlay > Video title page.
- 4 Set the **Title page duration**, in seconds. This controls how long the title page is displayed at the start of a video.
- 5 Set the **Enable video title page** slider to On to enable the title page.



*Fig. 5.14 Video Title Page Settings menu. 1 Enable video title page slider (shown in the On position).*

**Note:** *The setting only applies to videos recorded subsequently. Any existing videos saved on the controller are unaffected. In particular, if an existing video does not have a title page, it will not gain a title page if you subsequently enable the video title page.*




6 The change is saved automatically. Press Esc or the  **Back** button to quit the menu.

Alternatively, set the **Enable video title page** slider to Off to disable the title page in all videos that you record subsequently.

## 6 Operating the system

This section describes how to operate the C550c system.

### 6.1 Before you begin

-  *Assess your deployment and safety requirements before you begin. Different environments may pose risks and challenges that you may be unaccustomed to.*
-  *Check that no hazardous gases or vapors are present. Do **not** use the C550c system in potentially explosive environments.*
-  *Seek assistance if required and always use correct heavy-lifting practices.*

## 6.2 Confirming the system equipment

Every time the controller and tractor system are switched on, you are prompted to select and confirm the equipment attached using the Equipment settings menu. Whenever you change any part of your system, go to the Equipment settings menu to revise the selections via

Settings > Equipment

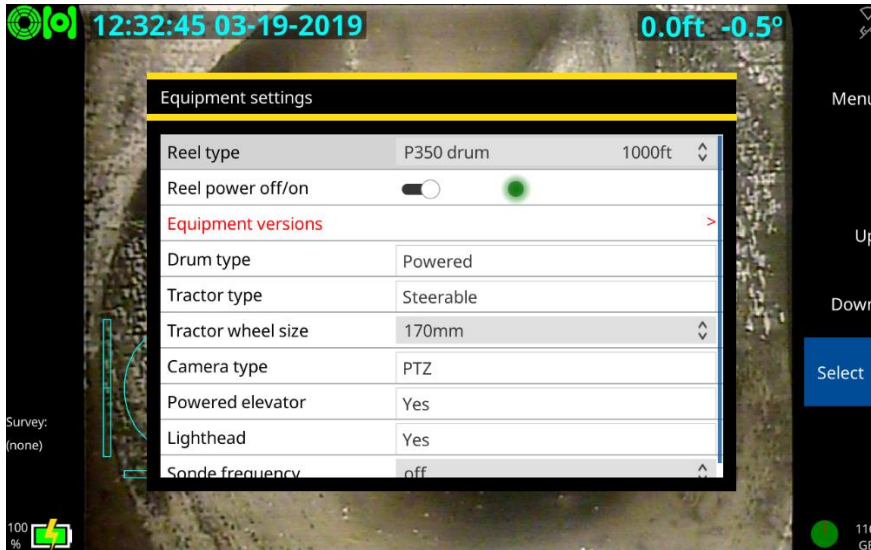


Fig. 6.1 Equipment settings menu.


For details of each submenu item, please see [page 110](#).

## 6.3 Emergency stop



The Emergency Stop button located on the PSU will shut down all system components apart from the P550 controller when pressed. As a fail-safe, the system must be reset before you can switch on the system again. Do not reset the system until it is safe to do so. To reset the system ensure the power is switched off at the main switch. Rotate the Emergency Stop button clockwise and then switch the power back on. Switch the power off before disconnecting any system components or if the system is not yet connected.

## 6.4 Crawler Deployment

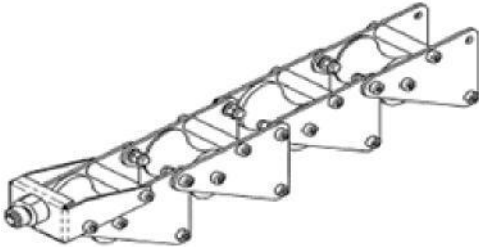
Once the system is correctly set-up, you can deploy the crawler in the pipe or conduit you wish to survey. Care must be taken when deploying the crawler, particularly if it is being deployed into deep conduits and cisterns via manholes with limited access.

 **Warning!** *The crawlers are heavy! Observe proper lifting procedures when handling, deploying and removing the crawler. Never lower crawlers or other heavy equipment into manholes while personnel are working in the manhole.*

### 6.4.1 Before deployment

-  *Assess your deployment and safety requirements before you begin. Different environments may pose risks and challenges that you may be unaccustomed to.*
-  *Check that no hazardous gases are present. The C550c flexitrac is not suitable for use in potentially explosive environments.*

We recommend the use of downhole and manhole rollers as there is a risk of damaging the crawler cable during a survey. They should be set before the crawler is lowered into the manhole and deployed in place before the survey starts.

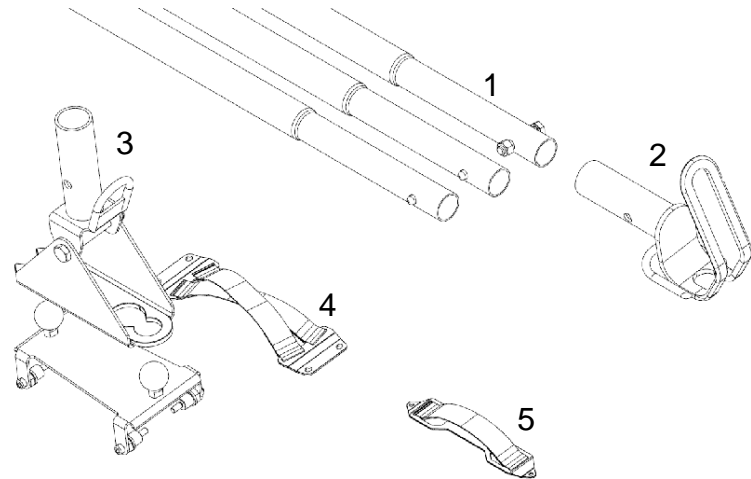


*Fig. 6.2 Downhole cable rollers (MK2).*

## 6.4.2 Using the crawler deployment tool

Depending on your system configuration the crawler deployment tool may have any of the following components:

- 1 3 poles, 6ft/1.8m length
- 2 Crawler hook
- 3 P356 Large Elevator grab system
- 4 P356 crawler strap
- 5 P354 crawler strap



*Fig. 6.3 Crawler deployment tool components.*

**Caution:** Do not attempt to lift the crawler by the system cable.

**Caution:** Do not drop the crawler as it may damage the camera and the system's electronics

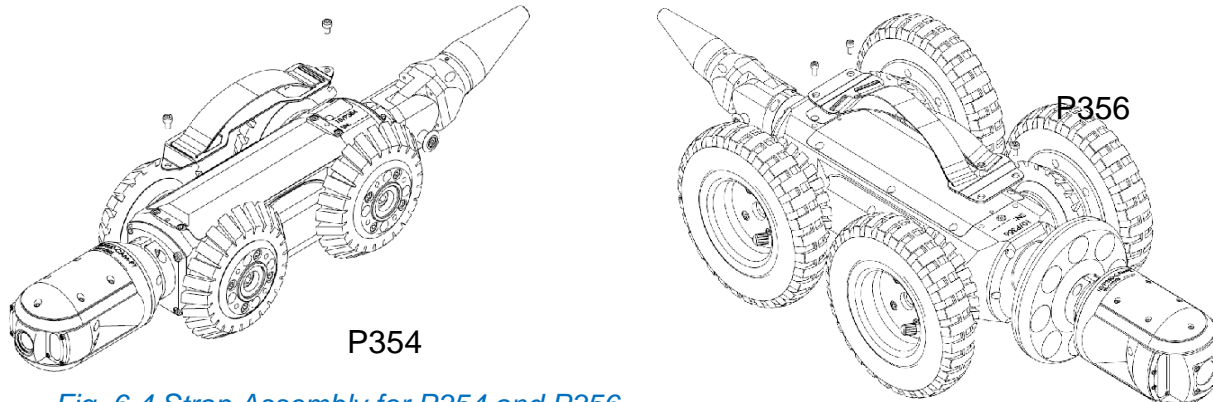
### 6.4.3 Set-Up

**Caution:** *Failure to follow this procedure may result in severe damage to the crawler and camera system*

#### Strap Assembly:

If using a crawler without the Large Manual Elevator you must fit the relevant crawler strap.

Using two (P354) × M4 x 6 SKT CAP SS or four (P356) × M6 x 8 SKT CAP SS screws (supplied), secure the strap to the crawler body, as shown below. The recommended torque for the M4 x 6 screws is 2.4Nm / 21.2 In-Lbs or 8.0Nm / 70 In Lbs for the M6 x 8 screws.



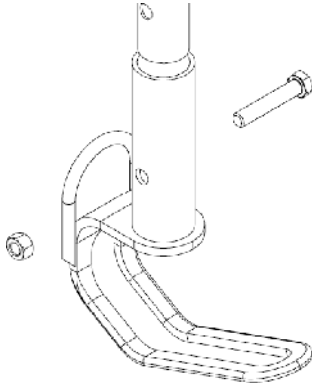
*Fig. 6.4 Strap Assembly for P354 and P356.*

**Caution:** *Do not over-tighten the screws*



#### 6.4.4 Strap hook setup

To use the straps to deploy or retrieve the crawler, you must attach the crawler hook to the bottom pole using the screw (3/8-16 UNC 2" HEX HD SS) and nut (3/8"x16U NC NYLOC SS) provided

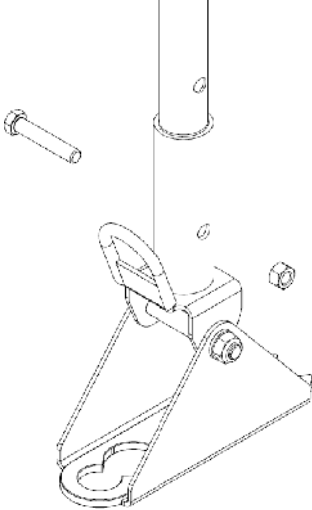


*Fig. 6.5 Strap hook assembly*

#### **Large Elevator Assembly**

When using a large elevator you must use the P356 Large Elevator grab system.

Attach the elevator cradle to the bottom pole using the screw (3/8-16 UNC 2" HEX HD SS) and nut (3/8"x16U NC NYLOC SS) provided.



*Fig. 6.6 Elevator cradle assembly*

Attach the bracket to the large elevator assembly following these steps:

- 1 Remove the 4x M6x16 screws using a 4mm Allen key
- 2 Remove the 4x bushes and friction o rings from the linkage arms
- 3 Fit the new adaptor bushes and o rings and tighten firmly (recommended torque 8Nm / 70 in-lbs) using a 15mm hex wrench.

- Secure the bracket to the elevator assembly using the new 4 off M6x12 screws supplied with the lifting tool, and tighten firmly (recommended torque 8Nm or 70 In-Lbs).

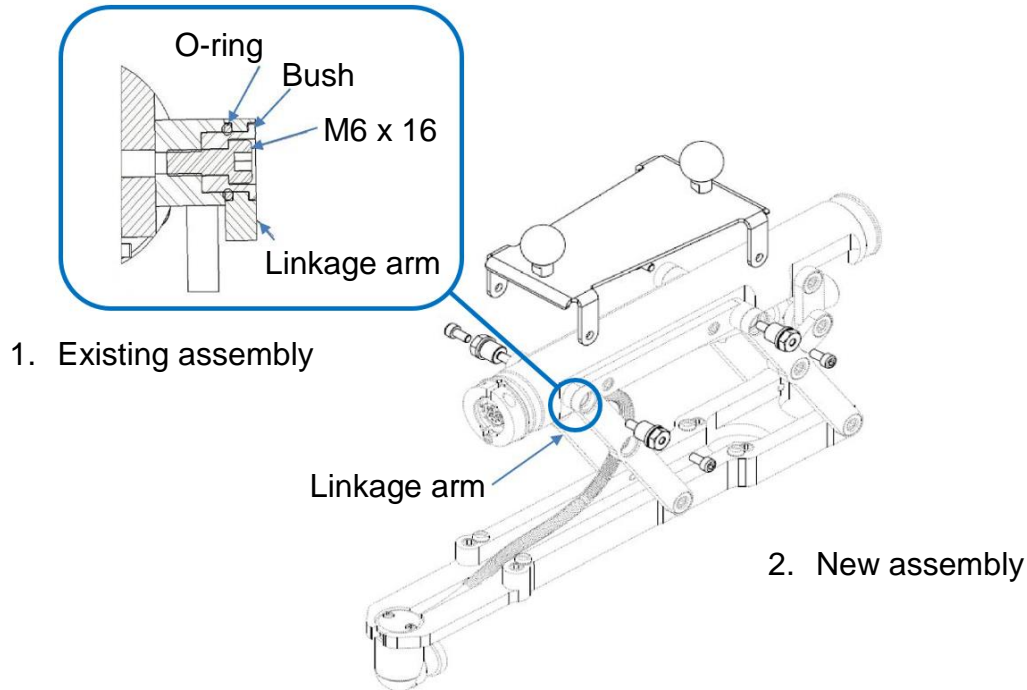
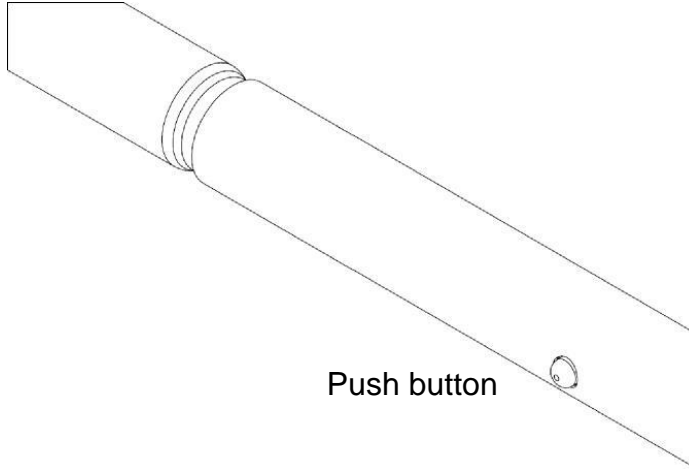


Fig. 6.7 Elevator bracket assembly

### 6.4.5 Poles

Connect as many poles as required ensuring that the push button is fully engaged.

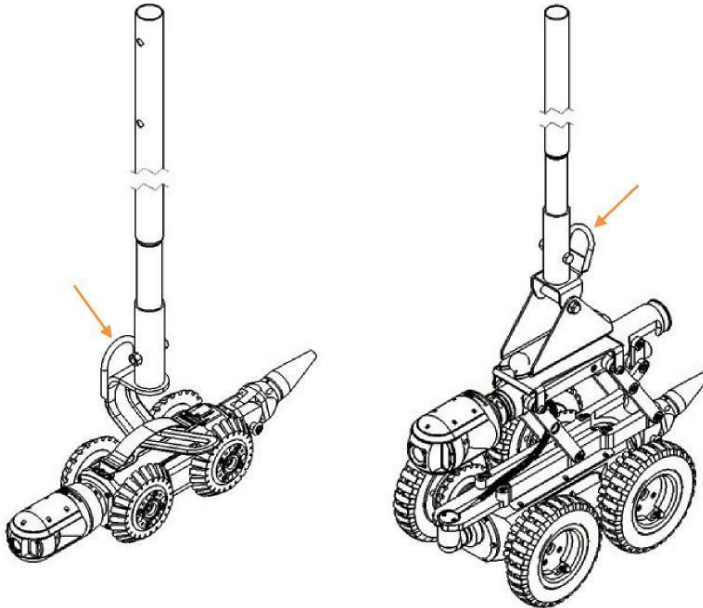


*Fig. 6.8 Poles assembly*

### 6.4.6 Using the deployment tool

Once ready you can use the deployment tool, you can hook the strap or engage the cradle to the large elevator bracket as shown below to lift the crawler assembly.

Ensure that the hook or the cradle is properly engaged to the strap or elevator bracket before trying to lift the crawler. We recommend the use of a suitable rope to stabilize and aid the deployment/retrieval operation. Use the highlighted eyes to secure the rope to the hook or cradle.



*Fig. 6.9 Using the deployment tool*

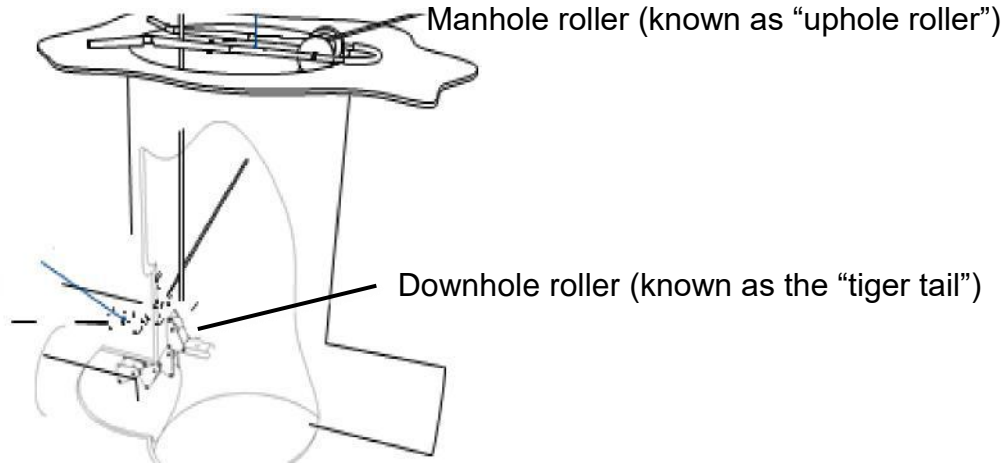
**Caution:** Choose high-quality rope that is certified to hold at least 50kg / 110lb (for P354 crawlers) or 100kg / 220lb (for P356 crawlers).

**Warning!** Clean and sanitize the crawler straps with a suitable disinfectant (such as Presept from Johnson & Johnson) at regular intervals to help prevent the risk of biological contaminations from foul water sources. Use appropriate gloves when cleaning the system.

### 6.4.7 Cable deployment rollers

The optional cable deployment rollers help protect the cable from scoring on concrete and other abrasive materials. CUES recommends that you always use cable deployment and removal rollers.

Use of a manhole roller and the protective downhole tiger-tail rollers is demonstrated below. Note the position of the tiger-tail roller below the surface.



*Fig. 6.10 Using rollers to reduce cable wear*

#### **6.4.8 Distance counter and stop point**

Once you have deployed and positioned the crawler in the manhole, using manhole rollers to protect the cable and ensuring that the cable protection spring has cleared the drum rollers, you should zero the distance counter.

The zero (0.0) position is used to decide when to stop the system when reversing the crawler. This is a safety feature.

You can reset the counter to zero at any time during operation by pressing Panel button 2, see [page 33](#).

**Note:** *Resetting or varying the distance counter during a survey will render the automatic retrieval function ineffective as the crawler will return to the new zero position and not the point where the crawler began the survey.*

### 6.4.9 Sonde

The P550 crawlers feature an integrated, multi-frequency sonde. The Sonde allows you to locate the crawler's position using a CUES cable and pipe locator such as an Accupoint MS610 or a Radiodetection RD5100S or RD7100DL.

You can choose the transmitting frequency in one of two ways:

- 1 From the home screen, press panel button 3 (see [page 33](#)) to cycle round the available frequencies
- 2 Using the *Sonde frequency* item in the *Equipment settings* menu (see [page 111](#))

For more information on locating the sonde and frequency selection, please refer to the documentation supplied with your cable and pipe locator. The sonde should be used as an estimation tool for assisting with product location.



## 6.5 System stop

You can stop the drive system, including the crawler, powered drum and elevator by pressing either the STOP button or the Spacebar on the keyboard. Pressing the joystick down will also stop the system. See [page 158](#) for details on using the joysticks.

When using the Pendant, for safety this is controlled via the Pendant or the emergency stop button on the drum. Pressing the joystick down will stop the system.

While stopped, the crawler will automatically brake, indicated by the red STOP LED lighting



*Fig. 6.11 STOP button and red STOP LED*

## 6.6 Driving the crawlers

This section describes driving and retrieving P550 crawlers when used with the manual or powered drum. Although the principle is the same, the powered drum can retrieve the cable and crawler automatically. You can use the C550c controller or the Pendant controller to control the crawlers.

**Note:** *Make sure you have set the correct wheel size before you attempt to drive the crawler.*

**Note:** *You must be at the home screen to drive the crawler or powered drum. If you open a menu at any time while the drum or crawler are moving:*

- *they will stop moving immediately,*
- *the crawler's brake will be applied and*
- *you will not be able to move them until you have returned to the home screen.*

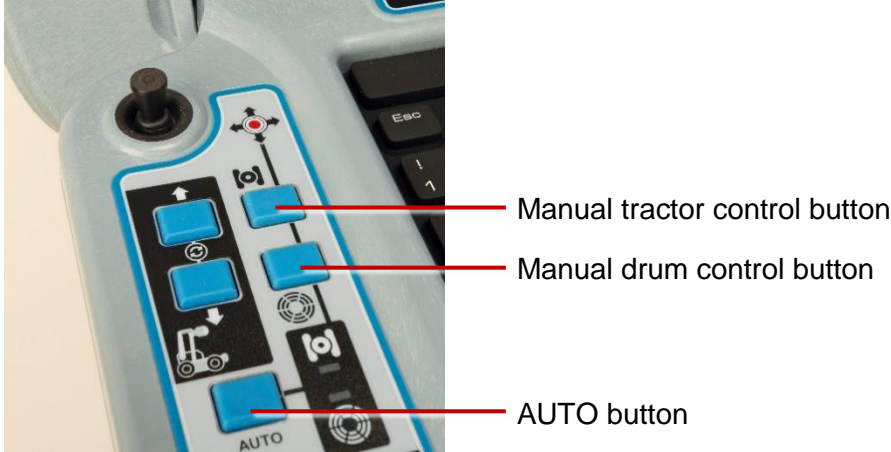
CUES recommends that you practice driving the crawler on the surface in a safe environment before attempting to deploy the crawler underground for the first time. In addition to practicing driving techniques, it provides a good opportunity to understand how the system operates.

### 6.6.1 AUTO and manual modes

In AUTO mode the powered drum automatically manages the cable when the crawler moves. In manual mode, the joystick controls either the tractor or the powered drum, whichever you have selected. This means that in manual tractor mode, the tractor drives unassisted and the drum does not recall the cable.

CUES recommends using AUTO mode as the drum and crawler operate in tandem and gives less likelihood of driving over the cable.

To select AUTO mode, press the AUTO button, see below. To select manual tractor or manual drum mode, press the relevant button, see below.



*Fig. 6.12 Keypad showing AUTO button, and manual tractor and drum buttons*

In manual mode, the LED corresponding to the chosen mode will light; the manual tractor indicator LED is green and the manual drum indicator LED is yellow.

In AUTO mode, both LEDs will light.

## Manual system

### Moving forwards

To move the crawler forward, push the joystick away from you. Continuing to hold the joystick forward, or pushing it further, will increase the crawler's speed until it reaches its maximum speed.

To slow the crawler, pull the joystick towards you. Holding it down will slow it down more quickly.

**Note:** *If you continue to pull the joystick towards you when the crawler has stopped, it will reverse. The crawler will automatically stop when the cable counter reaches 0.0.*

## Reversing

**Caution:** *When reversing or retrieving the crawler, ensure that the cable is retrieved at the same or higher speed than the crawler. Failure to do so may cause the crawler to get tangled in the cable and stall.*

Use the crank handle for winding in the cable, see [page 156](#). Use the manual wind layering handle to ensure the cable is laid evenly in the drum.

**Note:** *A message will flash on your screen warning of a cable hazard. This message will not be recorded to video.*

Pull the joystick towards you to reverse the crawler. Increase the speed by continuing to pull it or by pulling it further towards you. Decrease the speed by pushing it forwards.

## Powered drum system

## Moving forwards

To move the crawler forward, push the joystick away from you. Continuing to hold the joystick forward, or pushing it further, will increase the crawler's speed until it reaches its maximum speed.

To slow the crawler, pull the joystick towards you. Holding it down will slow it down more quickly.

**Note:** *If you continue to pull the joystick towards you when the crawler has stopped, it will reverse. The crawler will automatically stop when the cable counter reaches 0.0.*

## Reversing

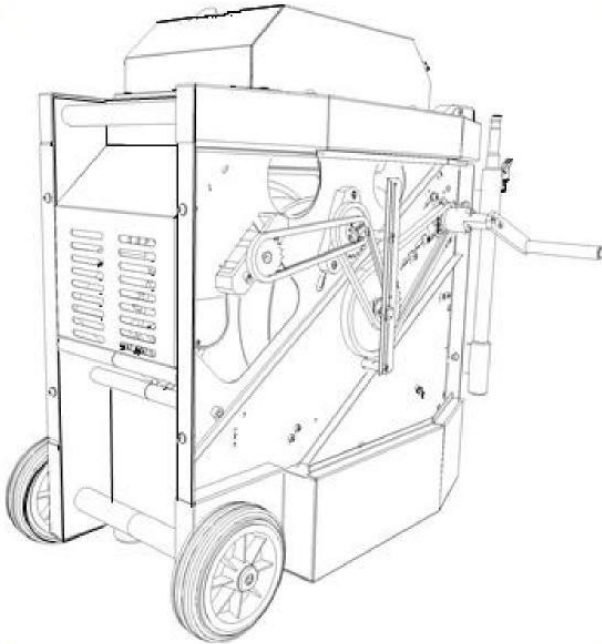
**Note:** *The crawler will automatically stop when the cable counter reaches 0.0. However, the crawler's momentum may cause it to roll a short distance beyond the 0.0 position. Please allow for this when you deploy the camera and zero the distance counter.*

The powered drum supports two driving modes: AUTO and Manual. In Manual mode, the crawler and drum operate independently. Manual driving gives you more control over the crawler and drum but can increase the risk of jamming the cable around the crawler wheels, particularly if the crawler reverses over the cable.

## Manual retrieval with the crank handle

If necessary, use the crank handle to manually wind the cable back into the drum. Before you start, disconnect the power lead to ensure that the system is not powered. The crank socket is located under

the side panel closest to the controller socket. The panel is secured with socket-head screws. Remove this panel using a metric Allen key.



*Fig. 6.13 Crank handle for powered drum.*

Attach the crank handle to the crank socket located in the gear on the top right-hand corner of the compartment using the supplied socket head screws.

**Caution:** *Remove the crank handle and replace the side panel before reconnecting power to the system.*

### 6.6.2 Steering (P356 crawler only)

The P356 crawler will steer left and right, allowing you to navigate pipes with ease. The crawler steers by changing the speed on the left or right motors.

You can steer the crawler when it is moving or when it is stationary. Steering whilst reversing is possible in manual driving mode only.

**Note:** *Steering whilst moving is proportional to the crawler speed: the faster the crawler moves the bigger the steer.*

Manual mode provides a tighter turn than AUTO mode.

When the crawler is stationary, it will turn on its own axis. Be careful as the cable can get jammed around the wheels.



### 6.6.3 Analog joystick control

The left hand joystick provides intuitive control of the crawler.

- The front/back joystick axis controls the acceleration of the crawler.
- The left/right axis controls the steering of the P356 crawler.
- Pressing down on the joystick will bring the crawler to a stop.
- The right hand joystick provides intuitive control of the camera.
- Use Keyboard shortcuts as an alternative for the joysticks to control the movement of the crawler, powered drum and camera; see [page 105](#).

### 6.6.4 Topple warning

P550 systems offer an automatic TILT warning. This will be displayed when its roll exceeds 35°.



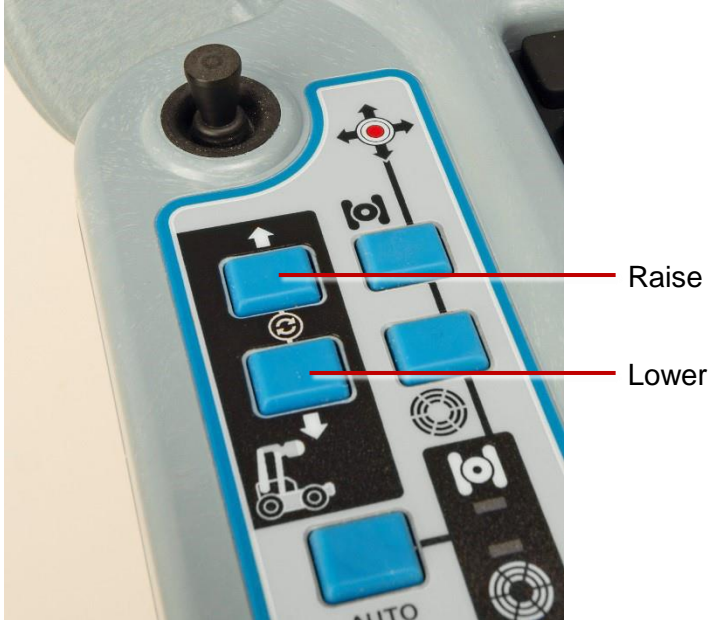
MIMIC also showing  
high tilt angle

Topple angle warning

*Fig. 6.14 Topple warning shows at the bottom of the screen. Note that the MIMIC also shows a high tilt angle.*

### 6.6.5 Powered elevator control

The associated buttons control the elevator position when the powered elevator is fitted, see below.



*Fig. 6.15 Powered elevator control buttons*

Pressing both buttons at the same time resets the powered elevator, moving it to its lowest position. Pressing the keyboard spacebar will immediately stop all powered elevator movement.

## 6.7 Camera control (lights, focus, pan, rotate, zoom)

The C550c cameras have a range of features to help you locate faults in more demanding conditions. These are controlled by the right hand joystick and buttons.



*Fig. 6.16 Right hand joystick and camera & lighting control buttons*

### 6.7.1 Analog joystick control





The right hand joystick provides intuitive control of the connected camera.

- The left/right axis controls the pan function,
- The front/back axis controls the tilt/rotate function
- The result of pressing down on the joystick depends on the camera positioning mode you have chosen. You can choose between *Direct* and *Go To*. See [page 164](#) for details.
- Use Keyboard shortcuts as an alternative for the joysticks to control the movement of the crawler, powered drum and camera; see [page 105](#).

### 6.7.2 Camera focus control



The ∞ and ● control the camera's focus. ∞ for far away objects and ● for close objects. Pressing and holding either button continues the focus operation in that direction. Pressing both buttons together resets the focus.

### 6.7.3 Camera zoom control

The  and  control the camera's zoom.  zooms in and  zooms out. Pressing and holding either button continues the zoom operation in that direction. Pressing both buttons together resets the zoom.

### 6.7.4 Camera iris control



On occasion, there may be a requirement for manual control of the iris to change the picture brightness (e.g. to reduce reflections from a shiny surface). Manually opening the iris allows more light to enter the camera giving a brighter picture. Closing the iris decreases the amount of light entering the camera giving a darker picture.

The  and  control the camera's iris. Pressing and holding either button continues the iris operation in that direction. Pressing both buttons together resets the iris.

**Note:** *The LED beneath the iris control buttons is not currently used.*

### 6.7.5 Lighting control

The lighting control allows you to alternate and adjust intensity between camera lights, auxiliary lighthead (if available) and no lights. Pressing both buttons together cycles round the available options.

Press the  button to increase brightness and press the  button to reduce it.

### 6.7.6 Camera position control modes

C550c offers two camera positioning control modes:

- *Direct*, and
- *Go To*.

Pressing the camera mode control button cycles between these two modes.

**In *Direct* mode**, the camera responds immediately to the joystick movement. Pressing the joystick button down returns the camera to its front, central position.

**In *Go To* mode**, the joystick controls the position of a target, ⊕ , in the MIMIC see [page 165](#). Remembering that the MIMIC provides a 2D image of the 3D camera position, place the target where you want the camera to point and press the joystick button down; the camera will then move to this point.

If MIMIC has been disabled in the *Settings* menu, selecting *Go To* mode will automatically enable it so you can see the target and position it as you want.

**Note:** *Camera positioning is not available for fixed, forward view cameras, or pushrod cameras.*

### 6.7.7 Joint scan

When the Joint Scan icon (see [page 165](#)) is available (for Pan & Tilt and Pan, Tilt & Zoom cameras) pressing the associated ATM button initiates a Joint Scan operation.

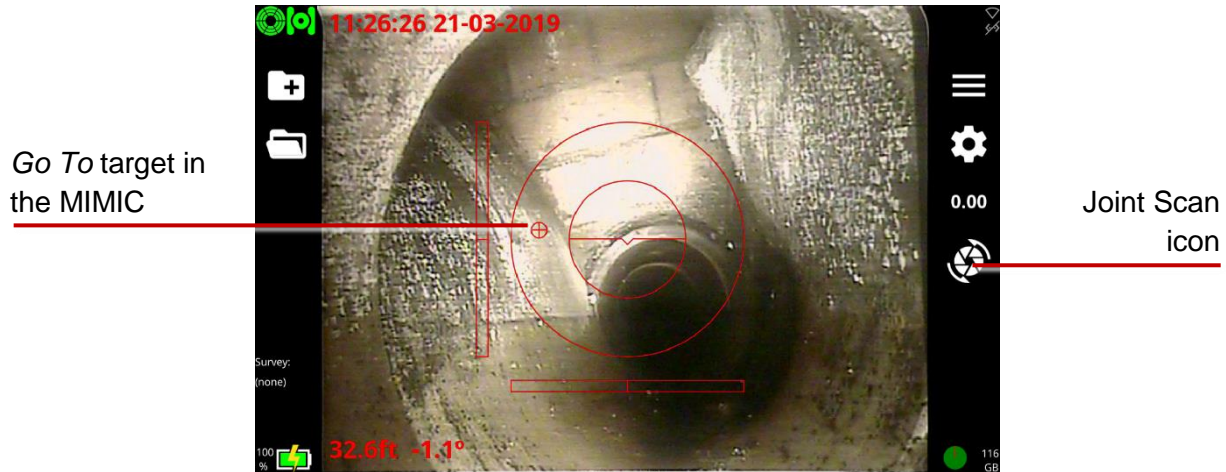


Fig. 6.17 MIMIC with Camera Go To target, and Joint Scan icon





## 6.8 Pushrod reels

Whenever you connect a pushrod as part of your P550 system, it prompts you to select the reel type and calibrate the reel. You must also calibrate the new reel if you change reels (connect a different reel to the controller). The reel must be correctly calibrated to ensure that camera distances are accurate.

**Note:** *For definitions of calibration and zero distance, see [page 22](#).*

Follow these steps:

- 1 Rewind the pushrod completely.

Make sure the pushrod is layered evenly and correctly onto the reel *and* the end of the rod is level with the rod guide.

- 2 Power on the controller.

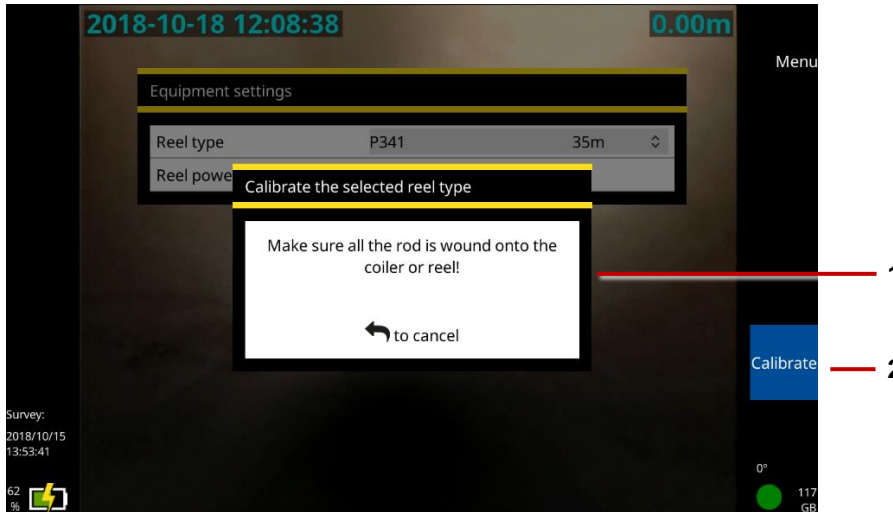
- 3 In the Equipment settings menu, select the **Reel type** you are using from the dropdown list and ensure Reel power is on. Then press Select.

**Caution!** *It is essential that you select the correct reel for best video quality and accurate distance measurements. If you select the wrong reel, pushrod distance measurements will not be accurate and your survey may be unusable.*

- 5 The controller now displays an advisory reminding you to fully rewind the pushrod.

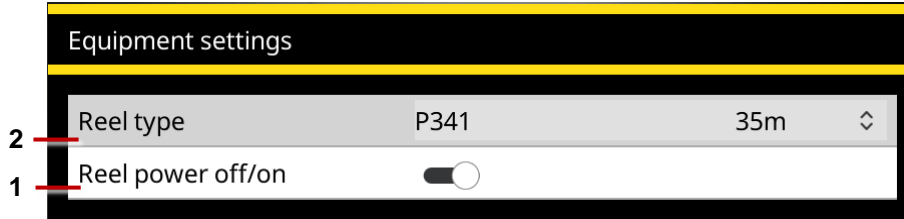
If the rod *is* fully coiled on the reel, press the **Calibrate** button.

If the rod is *not* fully coiled on the reel, rewind the rod completely. Then press **Calibrate**.



*Fig. 6.18 Calibration reminder. 1 Advisory to rewind the rod. 2 Calibrate button.*

If you connect a pushrod directly to the P550 controller, ie without using a powered drum or manual PSU in between, you will be shown the following *Equipment settings* menu. Again, select the reel you have connected.



*Fig. 6.19 Equipment settings menu for 1 Reel type. 2 Reel power off/on (shown in the On position).*

## 6.9 Deploy pushrods

Unwind the pushrod some distance so you can deploy the camera down into a manhole before starting the pipe survey. Follow these steps:

- 1 Slowly release the brake and rotate the reel to unwind the pushrod.

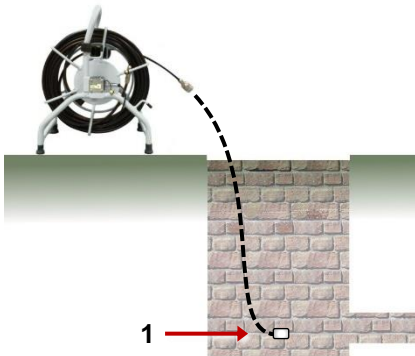
**Caution:** *Pushrods can self-propel and cause injury to the operator. We recommend that you adjust the brake slowly to prevent the reel unwinding too quickly. You can adjust the brake lever position by pulling it out and turning.*

- 2 When a sufficient length of pushrod is free, insert the camera into the pipe or manhole.
- 3 Push the pushrod by hand until the camera is in position to start the survey. Rotate the reel if you need more length.
- 4 Zero the camera distance; see [page 170](#).

## 6.10 Zero the camera distance

Your survey needs to accurately record the distance of the camera from the starting manhole. This ensures that pipe defects can be accurately located. However, in most cases you will need to unwind the pushrod some distance so you can deploy the camera down into a manhole before starting the survey.

To ensure accurate camera distances are recorded in your survey videos and observations, you need to zero the camera distance when the camera is in position (typically in the center of a manhole) before you start the survey.



*Fig. 6.20: Zeroing the camera position. 1 Zero the camera position when the camera is here.*

**Note:** This task is also called ‘zero distance’ and ‘zeroing the rod counter’. Do not confuse this task with zero calibration of the reel. See the definitions in [page 22](#).

Follow these steps:

- 1 Get the camera in the survey start position; see [page 169](#).
- 2 Press the **0.00** **Set distance** button or **0.00** *panel button* and reset the distance to 0.00.
- 3 Make sure the on-screen distance counter shows **0.0ft** or **0.00m**; see item 2 on [page 34](#).

## 6.11 Streaming images to a nearby device

You can share the image(s) on your display by streaming to a nearby connected device such as a cell phone or tablet. The nearby device needs:

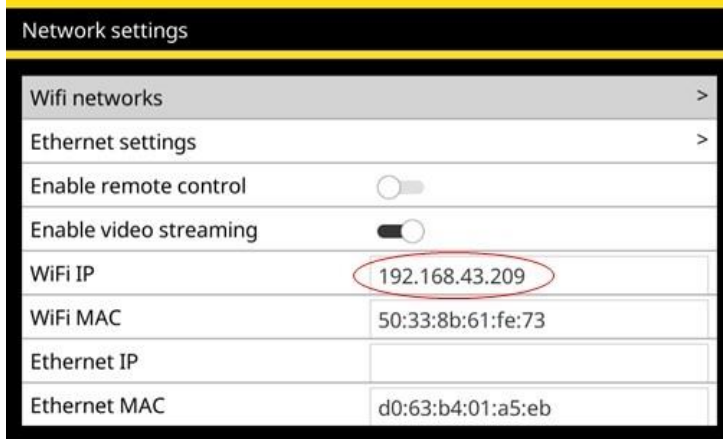
- an internet browser (CUES recommends Chrome 71 to 74, Safari 12 or later, or Microsoft Edge (contact CUES for version information)), and
- WiFi hotspot capability

### 6.11.1 Connecting to a nearby connected device

Firstly enable your device's WiFi hotspot, following the manufacturer's instructions, then activate WiFi networks on the P550 controller as described on [page 115](#).

- 1 Navigate to  
Settings > Network > Enable video streaming  
and activate it.
- 2 Note the IP address shown in the WiFi IP box





*Fig. 6.21: Network settings menu. The WiFi IP address to be copied to your device's browser is highlighted*

and enter it into the address bar of your device's browser and press Go

3 The streamed video will show in the browser, as shown below.



*Fig. 6.22: Example of P550 controller display image streaming to a nearby device's display, here an Android phone's Chrome 72 browser*

If you encounter difficulties, check that your browser is compatible with this feature (see above). You can also move your device closer to the flexiprobe P540c to help ensure a good connection between the two units.

## 6.12 Record a video

Recording a video is simple. Before you start recording, you just need to decide whether to add the video to a new or existing survey.

With the C550c system, all videos must be attached to a survey. You can set up a new survey when you launch a video recording ([pages 178 and 179](#)), or you can open an existing survey and add new video recordings to it ([page 181](#)).

### 6.12.1 Video format and size

The C550c system saves survey videos as MP4 files, encoded in H.264 for video and MP3 for audio.


The controller limits individual MP4 files to 4GB, corresponding to a survey video of approximately two hours. If a video recording is underway when you reach this file size limit, the controller automatically stops the recording. If your survey is likely to exceed two hours, you will need to record two separate videos.

**Note:** *This size limit allows you to export survey videos to a USB memory stick. The memory sticks supported by the controller use the FAT32 file system. Individual files on FAT32 drives cannot exceed 4GB in size.*

### 6.12.2 About the panel buttons

Use the panel buttons to record, play, pause and stop a video. You can also capture still images ie, observation photos. The panel buttons are located below the controller screen; see [page 33](#).

 Record/Pause

 Play/Pause




 Stop

 Camera

 Set Camera Distance

### 6.12.3 On-screen recording indicators

While a recording is in progress, recording status indicators are shown in the lower-right screen:




- A red dot  on the screen indicates that recording has started. Also the red Recording LED will light. See [page 32](#).
- The mic symbol indicates whether audio recording is on  or muted .
- There are timers for the current recording plus the *estimated* total recording time available, based on the current level of free disk space.



*Fig. 6.23 Recording status indicators. 1 Recording in progress. 2 Audio recording on. 3 Timer for current recording. 4 Total recording time available (estimated). 5 Recording paused. 6 Audio recording muted.*

## 6.12.4 Quickly record a new video

*(Available for basic surveys only)* This is the fastest way to record a new video:

- 1 *(Optional)* Connect a headset to record an audio commentary.
- 2 Press the  panel button twice to automatically set up a basic survey and start recording.
- 3 Now carry out the video inspection. Use the controller tools to:
  - Pause the recording, rotate the camera, use a sonde, mute an audio commentary, and highlight pipe defects. See [page 182](#).
  - Take a photo. See [page 183](#).
  - Add an observation. See [page 224](#).
- 4 Press the  panel button or  **Stop** button to stop the recording.

**Note:** *The survey name defaults to the current date and time. To rename the survey, see [page 203](#).*

### 6.12.5 Set up a new survey and record a new video

Follow these steps:

1 (Optional) Connect a headset to record an audio commentary.

2 Press the  panel button.

3 Before the video starts recording, you must specify the following details:

**Name:** The survey name defaults to the current date and time, but you can set a custom name. You can also rename the survey later; see [page 203](#).

**Format:** Choose one of the following:






- **Basic survey:** You do not need to specify any details at this point. If required, you later edit the survey head to specify the operator (the person carrying out the survey), job number, date and time, location of the survey, plus any remarks. See [page 204](#).
- **Structured survey (WRc):** You must choose the survey standard. For example, you can choose MSCC5 Sewerage, MSCC5 Domestic or MSCC5 Highways. For a list of currently supported standards, see [page 234 and the pages that follow](#).
- **Structured survey:** Choose between French and Spanish versions of EN13508.


4 Select the **Continue** menu item.

5 (Applies to Structured and WinCan surveys only) Fill out the details required for your chosen survey standard.

- The current field is highlighted in gray.
- Mandatory fields are highlighted in yellow.



**Tip:** Press the **Super tab** button to quickly tab through the mandatory fields only. You can fill in the other fields later; see [page 204](#).

- Press the     arrow keys to move through all the header fields.
- Fields with  buttons have a drop-down menu. For drop-down menu shortcuts, see [page 234](#).
- Press Save to save the form.

6 (Applies to Structured and WinCan surveys only) Press the  panel button to start recording.

7 Now carry out the video inspection. Use the controller tools to:





- Pause the recording, rotate the camera, use a sonde, mute an audio commentary, and highlight pipe defects. See [page 182](#).
- Take a photo. See [page 183](#).
- Add an observation. See [page 224](#).

8 Press the  panel button or  **Stop** button, and press Yes to confirm, to stop the recording.



### 6.12.6 Record a further video for the survey currently open

You can record multiple videos for a single survey. Follow these steps:







- 1 (Optional) Connect a headset to record an audio commentary.
- 2 Open the survey that you want to update; see [page 201](#).
- 3 Press the  *panel button* once.
- 4 According to the survey standard chosen, a pop-up menu Multiple video recordings may be displayed. Press Yes if you want to add a VVR condition code to the observations, otherwise press Esc or the  **Back** button to continue without recording the VVR code.
- 5 Now carry out the video inspection. Use the controller tools to:
  - Pause the recording, rotate the camera, use a sonde, mute an audio commentary, and highlight pipe defects. See [page 182](#).
  - Take a photo. See [page 183](#).
  - Add an observation. See [page 224](#).
- 6 Press the  *panel button* or  **Stop** button to stop the recording.

## 6.13 Video tools

The controller provides various tools to augment or enhance your survey videos.



### 6.13.1 Pause, resume and stop recording

You can pause and resume a video recording at any time. For example, you may want to pause the video while you highlight a pipe defect with an on-screen arrow or circle.

- **On-screen indicators:** A red dot  and video counter are shown on the screen when the controller is recording a video.
- **Pause a video:** While a video is recording, press the  panel button to pause the recording.  
**Note:** You cannot press the  panel button to pause or resume a live recording.
- **Resume a paused video:** While a video is paused, press the  panel button again to resume recording.
- **Stop a video:** While a video is recording or paused, press the  panel button or  Stop button.

### 6.13.2 Rotate the video feed

You can rotate the video feed on the screen at any time.

Press the  or  buttons to rotate the video clockwise or anticlockwise. The angle of rotation in degrees is shown bottom left of the screen. Note that the camera itself is not physically rotated.

### 6.13.3 Take a photo

You can take photos (ie, capture screenshots) at any time when a survey is open. For example, you can take photos while recording or playing a video. You can also take photos directly. Any photos taken while a survey is open are listed in the survey report when you export the survey.

A photo is saved automatically as a .jpeg image each time you add an *observation*. The photo shows exactly what is on the screen at the time of the observation. To review your photos later, you open the associated observations.

To take photos directly, see [page 191](#)

To add an observation while recording or playing back a video, see [page 222](#).

For details about survey reports, see [page 231](#).

### 6.13.4 Add overlay text and shapes to video segments

While recording a survey video, you can add text and shapes to highlight pipe defects. These *overlays* are displayed over the video footage.





*Fig. 6.24: Adding overlay items to a video recording. 1 Overlay text and shapes. Buttons: 2 Add shape. 3 Add text. 4 Add graphic. 5 Select item. 6 Delete item. 7 Enlarge item. 8 Shrink. 9 Enable overlay / Disable overlay.*

You can precisely resize and position the overlays and you can control how long (in seconds) they are displayed on the screen.

For example, you may want to add a 10-second overlay to your video, comprising an arrow and explanatory caption, to highlight a crack or debris.

**Note:** *You cannot add overlays after recording the video. For example, you cannot add a new arrow and text caption while playing back a survey video. (Of course, you can export the .mp4 video and overlay graphics and captions using third party video editing software.)*

Follow these steps:

- 1 Start recording a survey video; see [page 172](#).
- 2 Press the  *panel button* to pause the recording when you observe a pipe defect or another feature that you want to highlight.
- 3 With the video paused, press the  **Overlay graphics** button.
- 4 **Add overlay items.** Choose from:
  - **Shapes:** Use squares, circles and arrows to highlight features visible on the screen.
  - **Text:** Add explanatory captions.
  - **Graphics:** Add any custom images, such as a hazard symbol. (First, you need to save the image to a USB memory stick and insert the memory stick into a controller USB port. Use the ↑↓ arrow keys and the Enter key to select the image you want.)

5 **Position and edit each item.** While video recording is paused:

a. Press the **Select item** button repeatedly until the item you want is highlighted in red.

**Note:** If you have set the overlay text color to red, then the selected item is yellow.

b. Use the ← → ↑ ↓ arrow keys on the keyboard to position the item on the screen.

c. Shapes and graphics: Press the **Enlarge** or **Shrink** buttons to resize the item.

d. Text: Press Enter on the keyboard to edit the caption. Press Enter again to save the changes.  
If you need to remove an item, press the **Delete** button.

6 **Enable the overlay.** Press the **Enable overlay** button.

*Do not omit this step. You must enable overlays to make them visible in your video recording!  
They will stay visible until you disable overlays in step 8.*

7 **Resume recording** for several seconds *but do not move the camera!*

For example, to display the overlays for 10 seconds, resume recording for 10 seconds. The overlay items will remain visible during this segment of the video. You could also record an audio commentary over this segment, for example, to explain the highlighted pipe defect.

8 **Disable the overlay.** Press the **Disable overlay** button to remove the overlay items from the next video segment. (You do not need to pause the recording to do this.).

9 Continue the pipe survey.

If you detect further pipe defects that you want to highlight, repeat steps 2 through 8.

### 6.13.5 Record an audio commentary

You can add an audio commentary while recording a survey video.

- 1 Attach a mic or headset to the covered audio socket on the front of the controller (item 3 on [page 27](#)).
- 2 Start recording a survey video.

Audio recording is enabled by default, so you can immediately start speaking into the microphone.

- 3 *(Optional)* To mute the microphone, press  *panel button*. To unmute and resume audio recording, press the button again.

To listen to an audio commentary, see [page 188](#).

**Note:** *You cannot add or edit the audio commentary after recording the video. For example, you cannot add a new audio commentary while playing back a survey video. (Of course, you can export the .mp4 survey video and edit the audio track using third party video editing software.)*

### 6.13.6 Listen to an audio commentary


When playing back an inspection, you can listen to the audio commentary on a headset or on loudspeakers attached to the controller.

- 1 Attach a headset or speakers to the covered audio socket on the front of the controller (item 3 on [page 27](#)).

You must use speakers with a 3.5mm audio jack; you cannot connect USB or Bluetooth speakers to the controller.

- 2 Play the survey video; see [page 189](#).
- 3 If required, adjust the playback volume; see [page 190](#).

### 6.13.7 Use a sonde

*Reserved for future use.* In future releases, this  panel button will operate a sonde independently of the camera.








## 6.14 Replay a video

To replay a video, you must first open the survey that the video is attached to. While the video is playing, you can stop, pause, forward and rewind, and add new observations.



*Fig. 6.25: Video playback screen. 1 Next observation button. 2 New observation button. 3a, 3b Rewind and Fast Forward buttons. 4 Stop button. 5a Volume Control button. 5b Volume level Use the ← → arrow keys to adjust the volume.*

Follow these steps:

- 1 Open a survey; see [page 201](#).
- 2 Press the  *panel button*; see [page 176](#).
- 3 Available videos are listed in the *Video browser* screen.
- 4 Use the  arrow keys to select the video you want. Then press Enter.
- 5 While the video playing, the *playback* buttons are available.  
The *playback* buttons allow you to: stop and pause the video; view and add observations; and fast forward or rewind the video.
- 6 To stop playing the video, press the  *panel button* or  **Stop** button.  
Or press the  **Back** button to quit the video and return directly to the *Edit Survey* screen.

### 6.14.1 Fast forward and rewind

Press the **Fast forward** or **Rewind** buttons. Each press increases the speed through x2 to x16.

### 6.14.2 Adjust the playback volume


Press the **Volume control** button. Then use the  arrow keys to lower or raise the volume.

## 6.15 Take a photo directly

Typically, you take photos (that is, capture still images) while recording or playing back a video. But you can also take photos directly, without recording or playing a video. For example, a survey video may be unnecessary because you only want to photograph a specific pipe defect.

Follow these steps:

- 1 Open an existing survey ([page 201](#)). Or create a new one ([page 196](#)).  
Photos are saved as observations, and each observation must be associated with a survey.
- 2 Deploy the camera into the pipeline.  
The camera feed is displayed on the controller screen. You can rotate the camera feed if necessary; see [page 183](#).
- 3 (*Optional*) When the camera is in position and the image you want is displayed on the controller screen, you can add overlay text and shapes to the image.  
For example, you can add an arrow and explanatory caption. For instructions, see [page 184](#).

- 4 Press the  panel button (page 33), or the New observation button to take the photo.

The photo shows exactly what is on the screen at the time, including any overlay text or shapes, camera rotation, date & time and camera distance.



*Fig. 6.26: Example screen display before the photo is taken.*

- 5 The *New Observation* screen displays, showing the new photo.
- 6 Fill in the fields required by the survey standard (see [page 224](#)). Then press the **Save** button to save the observation details and photo.

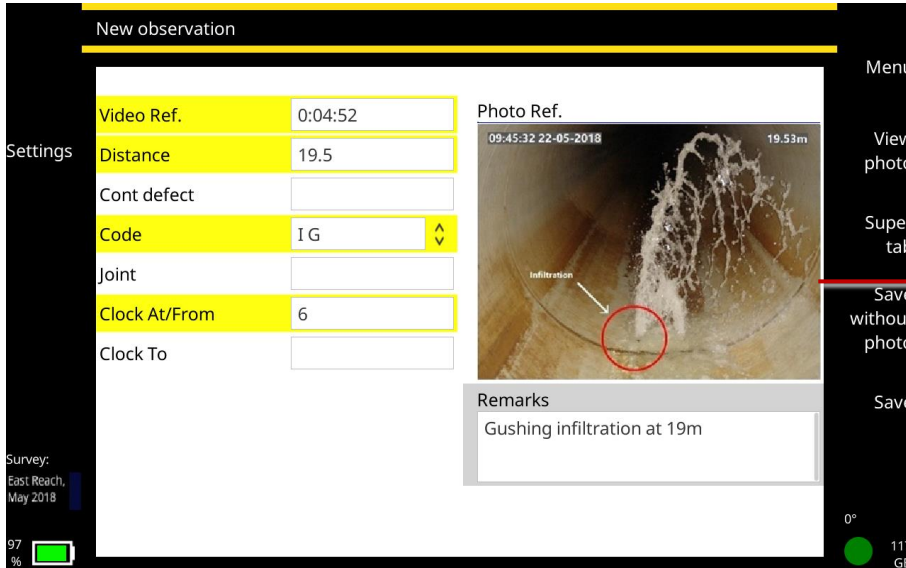

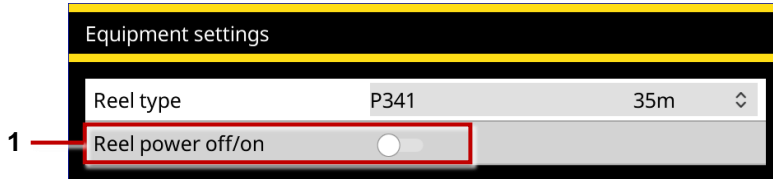


Fig. 6.27: *New Observation* screen showing new photo (1).

## 6.16 Turn off the camera

If the battery level is low on your controller, you can turn off the camera to save battery power:

- 1 In the Home screen, press the  **Settings** button (item 6 on [page 34](#)).
- 2 Choose Settings > Equipment.
- 3 Set the **Reel power off/on** slider to Off.



*Fig. 6.28: Equipment settings. 1 Reel power off/on slider (shown in the Off position).*

## 6.17 Retrieve the crawler



**Warning!** *Foul water systems can be a source of biological hazards. Maintain high sanitary standards at all times. Clean the system after each inspection with a cloth soaked in disinfectant. Always wear appropriate protection when conducting an inspection and when handling the equipment.*

After you complete the survey, wind the reel to retrieve the camera from the pipe.

- 1 Release the brake.
- 2 Carefully layer the pushrod onto the reel by a combination of rotating the reel and pushing the pushrod onto the reel. *Do not simply rotate the reel!*

**Caution:** *Layer the rod onto the reel evenly. If you fail to do so, displayed camera distances may be inaccurate when you next conduct a survey.*

- 3 Clean the pushrod and camera:
  - Clean the camera with water and disinfectant.
  - Clean the pushrod with a cloth moistened with disinfectant.


## 7 Surveys

This section describes how to create and manage pipe surveys (also called *pipe inspections*). The controller generates a survey *report* when you export the survey; see [page 205](#).

You can create *basic* or *structured* surveys. For structured surveys, the C550c controller supports WRc's MSCC 3 through 5 survey standards; see [page 237](#), and WinCan standards; see [page 237](#).

### 7.1 Create a new survey

Follow these steps:

- 1 In the home screen ([page 34](#)), press the  **Create survey** button.
- 2 In the *Create survey* dialog, set the survey details:

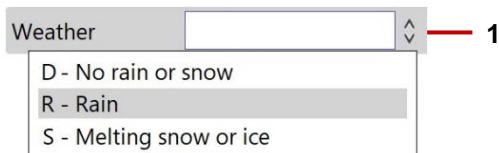
**Name:** The survey name defaults to the current date and time, but you can set a custom name.

**Format:** Choose one of the following:

- **Basic survey:** You do not need to specify any details at this point. If required, you can later edit the survey header to specify the operator (the person carrying out the survey), job number, date and time, location of the survey, plus any remarks. See [page 204](#).
- **Structured survey (WRc):** You must choose the survey standard. For example, you can choose MSCC5 Sewerage, MSCC5 Domestic or MSCC5 Highways. For a list of currently supported standards, see [page 234](#).



- **Structured survey:** Choose between French and Spanish versions of EN13508.
- 3 Select the **Continue** menu item.
  - 4 (*Applies to Structured and WinCan surveys only*) Now edit the survey header. For MSCC surveys, the header refers to the details recorded on an MSCC standard coding form (date, location, surveyor and so on). In the *Header* screen:
    - a. (*Optional*) Press the **Edit survey name** button and enter a descriptive name.
    - b. Fill in the fields required by the survey standard.
      - The current field is highlighted in gray.
      - Mandatory fields are highlighted in yellow. Press the **Super tab** button or Tab key to tab through the mandatory fields only.
      - Press the  $\leftarrow \rightarrow \uparrow \downarrow$  arrow keys to move through *all* the header fields.
      - Fields with  $\updownarrow$  buttons have a drop-down menu. For drop-down menu shortcuts, see [page 234](#).



*Fig. 7.1: Field with example drop-down menu. 1 Drop-down menu indicator.*

- 5 (*Applies to Structured surveys only*) Press the **Save** button to save the survey header details.

The *Edit Survey* screen displays ([page 199](#)). You can now set up a video title page ([page 129](#)) or start a recording a video ([page 172](#)).

## 7.2 Edit survey screen

Use the *Edit survey* screen to edit the video title page, edit the survey header details, and add or manage survey observations.



*Fig. 7.2: Edit survey screen. 1 New observation button. 2 List observations button. 3 Title page button. 4 Edit survey header button. 5 Close survey button. 6 Overlay graphics button (for observations). 7 Roll camera buttons.*

## 7.3 Manage existing surveys

Use the *Existing Surveys* screen to manage your existing surveys.


The screenshot shows the 'Existing surveys' screen. On the left, a vertical menu contains several options: 'Select multiple' (1), 'Delete selected' (2), 'Export selected' (3), 'Sort by title' (4), and 'Sort by date' (4). At the top left, the date '2018-05-24 14:14:34' and signal strength '0.86m' are displayed. A search bar is located at the top of the table area. The table lists surveys with columns for ID, Title, Survey type, Date, and time. On the right, a vertical menu includes 'Menu', 'Search' (5), 'Up', 'Down', and 'Open'. At the bottom left, there is a battery indicator showing 75% and a survey selection indicator for 'East Reach, May 2018'. At the bottom right, there is a storage indicator showing 102.5 GB.

ID	Title	Survey type	Date	&	time
14	East Reach, May 2018	MSCC3	2018-05-08		09:36
13	High Street, May 2018	MSCC5 Domestic Manhole...	2018-05-08		09:22
12	Dalston Road, May 2018	MSCC5 Highways Drain/S...	2018-05-08		09:05
11	Priory Way E, May 2018	MSCC5 Sewerage Manhol...	2018-05-08		09:04
10	Priory Way N, May 2018	MSCC5 Sewerage Drain/S...	2018-05-08		09:02
9	Haydon Lane, May 2018	MSCC5 Domestic Drain/Se...	2018-05-08		08:48
8	Silver Street, May 2018	MSCC4 Highways Drain/S...	2018-05-04		16:26
7	This is My New Survey Na...	MSCC4 Sewerage Manhol...	2018-05-04		16:25
6	Vine Court S, May 2018	MSCC4 Sewerage Drain/S...	2018-05-04		16:21
5	Vine Court N, May 2018	MSCC4 Domestic Drain/Se...	2018-05-04		16:01
4	Western Avenue, May 2018	MSCC5 Highways Drain/S...	2018-05-04		15:47
2	Trull Road, May 2018	MSCC5 Domestic Drain/Se...	2018-05-02		16:13

Fig. 7.3: Existing surveys screen. 1 Select Multiple button. 2 Delete Selected button. 3 Export Selected button. 4 Sort buttons (by title and date). 5 Search button.

### 7.3.1 Open a survey


In the C550c system, a survey must be open, or *active*, before you can record a video or take observation photos. Follow these steps:

- 1 In the home screen, press the  **Existing surveys** button
- 2 In the *Existing Surveys* screen, use the ↑↓ arrow keys to select the survey you want.
- 3 Press the **Open** button.

The *Edit Survey* screen displays; see [page 199](#).

### 7.3.2 Search for a survey

You can quickly search for surveys by ID, title or survey type. Follow these steps:


- 1 In the home screen, press the  **Existing surveys** button.
- 2 In the *Existing Surveys* screen, press the **Search** button.
- 3 In the Search field, type any numbers or words (or partial words) that appear in a survey's ID, title or survey type.

The screen updates as you type to list the surveys that match your search term. For example, type 'MSCC5' to search for all types of MSCC5 survey.

To clear the search and display all existing surveys, press the **Search** button again.

### 7.3.3 Sort surveys by title or date

You can sort surveys by title or date created. Follow these steps:


- 1 In the home screen, press the  **Existing surveys** button.
- 2 In the *Existing Surveys* screen, press the **Sort by title** or **Sort by date** buttons, as required. Press the buttons again to sort in reverse order.

To restore surveys sorted by ID, simply close and reopen the *Existing Surveys* screen.


### 7.3.4 Delete surveys

You can delete old surveys to free up disk space on the controller's internal storage.

#### ▪ Delete a single survey

- a. In the home screen, press the  **Existing surveys** button.
- b. In the *Existing Surveys* screen, use the  $\uparrow\downarrow$  arrow keys to select a survey.
- c. Press the **Delete survey** button.



#### ▪ Delete multiple surveys

- a. In the home screen, press the  **Existing surveys** button.
- b. In the *Existing Surveys* screen, press the **Select multiple** button.

- c. Use the keyboard to select the surveys you want to delete. Use the  $\uparrow$  $\downarrow$  arrow keys to highlight a survey. Then press Enter or the space bar to select the survey's check box. Or simply press the **Select all** button.
- d. To unselect a survey, you can clear its check box by pressing Enter or the space bar again. Or simply press the **Unselect** or **Unselect all** buttons.
- e. Press the **Delete selected** button to delete the selected surveys.



### 7.3.5 Rename a survey

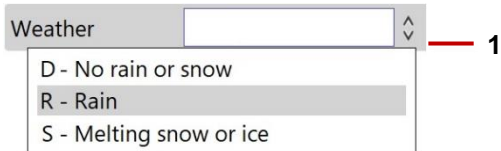
By default, the survey title is set to the current date and time. But you can set a custom title:

- 1 In the home screen, press the  **Existing surveys** button.
- 2 In the *Existing Surveys* screen, open the survey you want to rename.
- 3 Press  **Edit survey header** button.
- 4 When the survey header screen opens, press the **Edit survey name** button.
- 5 In the *Set survey name* dialog, enter the new title and press the **OK** button.

### 7.3.6 Edit the survey header details

If required, you edit any header details in your existing surveys. Follow these steps:

- 1 In the home screen, press the  **Existing surveys** button.
- 2 In the *Existing Surveys* screen, open the survey you want to edit.
- 3 Press  **Edit survey header** button.
- 4 When the *Survey Header* screen opens, tab to the field you want and enter the new details.
  - The current field is highlighted in gray.
  - Mandatory fields are highlighted in yellow. Press the **Super tab** button or Tab key to tab through the mandatory fields only.
  - Press the  $\leftrightarrow$   $\updownarrow$  arrow keys to move through *all* the header fields.
  - Fields with  $\updownarrow$  buttons have a drop-down menu. For drop-down menu shortcuts, see [page 234](#).



*Fig. 7.4: Field with example drop-down menu. 1 Drop-down menu indicator.*

- 5 Press the **Save** button.



## 7.4 Export a survey

You can export surveys to a USB memory stick, upload them to a Dropbox account, or send them to an email account. You can export individual surveys or you can export multiple surveys at the same time.

### 7.4.1 What is exported?

Depending on your chosen export method and export options, you can export all or some of the following:

- **Survey report (Microsoft Word DOCX):** The report is compliant with WRc MSCC standards. The exported file is [report.docx](#). For report details, see [page 231](#).
- **Survey report (XML):** You can optionally export survey reports in XML. For example, you may want to import your C550c surveys into a third party system. The exported file is [export.xml](#).
- **Survey videos:** Survey videos are saved as MP4 files, encoded with H.264 video and MP3 audio. Exported files have unique digital names. For example, [1525787329255.mp4](#).

**Note:** *When discussing video formats, it is important to distinguish between video coding formats (such as H.264 or MPEG-4 Part 2), audio coding formats (such as AAC or MP3) and multimedia container formats (such as MP4 or AVI). Briefly, video content (encoded with a particular video coding format) is combined with an audio stream (encoded with an audio coding format) inside a container format.*

*List continues on next page.*

- **Observation photos:** Still images captured from a survey video are saved as JPEG files. Exported files are numbered sequentially. For example, [1.jpg](#), [2.jpg](#), [3.jpg](#) and so on.
- **Target folder:** For exports to USB or Dropbox, surveys are exported to a [\[survey ID\]](#) target folder, where [\[survey ID\]](#) is the sequential ID number assigned to your survey by the controller. For an example, see [page 221](#).

**Note:** *You can only export survey videos and observation photos to USB or Dropbox. You cannot export them as email attachments.*

### 7.4.2 Export options




If exporting a survey to USB or Dropbox, you can choose any combination of export options.

If exporting a survey to email, you can only export the Microsoft Word survey report. You cannot export survey data & images or survey videos as email attachments.


- **Survey data & images:** Includes the survey report in XML format ([export.xml](#)), plus any observation photos. Note that photos are exported as JPEG images and numbered sequentially ([1.jpg](#), [2.jpg](#), [3.jpg](#) and so on).
- **Survey report:** Includes the survey report in Microsoft Word format ([report.docx](#)).
- **Videos:** Includes the survey videos. Survey videos are saved as MP4 files and have unique digital names (for example, [1525787329255.mp4](#)).

### 7.4.3 Connect to the internet

If you want to upload surveys to Dropbox or send them as email attachments, you must connect the controller to the internet before you start the export. The controller uses WiFi to connect to a suitable network. Follow these steps:

- 1 In the Home screen, press the  **Settings** button (item 6 on [page 34](#)).
- 2 Choose Settings > Network.
- 3 In the *Network Settings* screen, press the **Enable WiFi** button.
- 4 When the network list appears, use the   arrow keys to select the WiFi network you want. Then press the **Connect** button.

Wait while the controller connects to the selected network.

If the WiFi network has internet access, the connection icon changes to  and “(online)” is appended to the network name.

**Note:** *To switch to a different WiFi network, see [page 208](#).*

- 5 If you chose a secure network, the controller prompts you for the network password.  
By default, password characters are obscured, but you can click the **Show password** button to display the actual characters. This can be useful if you are unsure whether Caps Lock is on.

**Note:** *The Network Settings screen is described on [page 113](#).*

#### 7.4.4 Switch to a different WiFi network


If the controller is currently connected to a WiFi network, you must first disconnect from that network before you can connect to a different network. Follow these steps:

- 1 In the *Network Settings* screen, use the  $\uparrow\downarrow$  arrow keys to select the WiFi network you are currently connected to. Then press the **Disconnect** button.

The connection icon reverts to  ('not connected').


- 2 Use the  $\uparrow\downarrow$  arrow keys to select a new WiFi network you want. Then press the **Connect** button.

Wait while the controller connects to the new network.

If the new WiFi network has internet access, the connection icon changes to  and “**(online)**” is appended to the network name.

## 7.4.5 Select surveys for export

Follow these steps

- 1 (Email and Dropbox export only) Connect the controller to the internet; see [page 207](#).
- 2 In the home screen, press the  **Existing surveys** button.
- 3 In the *Existing Surveys* screen, select the surveys you want to export:

**Export a single survey:** Use the  $\uparrow\downarrow$  arrow keys to select a survey. Then press the **Export** button.

**Export multiple surveys:** Follow these steps:

- a. Press the **Select multiple** button.
  - b. Use the  $\uparrow\downarrow$  arrow keys to highlight a survey. Then press Enter or the space bar to select the survey's check box.
  - c. Repeat step b. for each survey you want to export. Or simply press the **Select all** button.
  - d. Press the **Export Selected** button
  - e. Choose whether to export the surveys as a single project or as individual surveys, then press **Select**. For a single project, give the project a name, then press **OK**.
- 4 In the *Export* menu, choose the export method and press OK:
    - **Export to USB:** Continue to [page 210](#).
    - **Export as email attachment:** Continue to [page 211](#).

- **Export to Dropbox:** *Only available if exporting a single survey.* Continue to [page 219](#).

### 7.4.6 Export to USB

After choosing USB as the export method, follow these steps:

- 1 If you have not already done so, insert a USB memory stick into one of the controller's USB ports.
- 2 In the *Select USB disk* screen, select your USB memory stick.
- 3 *(Optional)* Specify the survey options; see [page 206](#). That is, choose which items to export:
  - a. Press the **Export options** button.
  - b. Use the keyboard to select the items you want to export. Use the  $\uparrow\downarrow$  arrow keys to highlight an item. Then press Enter or the space bar to select its check box.
  - c. Press the **Save** button to save your export selections.
- 4 Still in the *Select USB disk* screen, press the **Continue** button to export the survey(s).

### 7.4.7 Export as email attachments

**Note:** *You can only export survey reports as email attachments. You cannot export survey videos or observation photos as attachments.*

After choosing Email as the export method, follow these steps:

- 1 (Optional) If required, press the **Network settings** button to connect to a different WiFi network.
- 2 (Optional) If required, press the **Email settings** button to change the email sender and server details.
- 3 In the *Send Email* screen ([page 212](#)), you must specify the email recipient(s). You can also write a brief message.
  - **Recipients:** To quickly choose a previous recipient, press the **Recipients** button. In the pop-up address book, use the  $\uparrow\downarrow$  arrow keys to highlight a recipient. Then press Enter to select their check box. Finally, press the **Add recipients to email** button. For details, see [page 212](#).
  - **Message:** The email subject and filename for the attached report are defined automatically, based on the survey title, but you can edit them if required.
- 4 Press the **Send** button to finish exporting the survey.

The image shows a 'Send email' interface. At the top is a black header with 'Send email' in white. Below is a white form area. The form has four main sections: 'To:', 'Subject:', 'Message:', and 'Attached filename:'. Each section has a red line with a number (1, 2, 3, 4) pointing to it from the left. The 'To:' field contains 'frank.schaeffer@spxdetection.com'. The 'Subject:' field contains 'report\_2018-05-04'. The 'Message:' field contains 'Sewer survey for Western Avenue, Bristol'. The 'Attached filename:' field contains 'report\_2018-05-04.docx'.

*Fig. 7.5: Send email screen. 1 Recipient. 2 Subject. Can be edited. 3 Optional Message. 4 Attachment filename. Can be edited.*

### 7.4.8 Email send failure

If your email failed to send, possible reasons include:

- 1 Email address and/or password was entered incorrectly – try re-entering these fields.



- 2 Hostname, port or SSL setting are incorrect
- 3 Your email security settings **may need** to be adjusted, which may require you to login to your e-mail account from a PC or mobile device. An example of the Gmail security settings is shown below (current as of writing this manual). For other e-mail providers, you may need to modify the settings accordingly.

To edit the Gmail security settings, visit <https://myaccount.google.com/> and sign into your account. You will then see the screen below. Click on **Security** and then **Get Started**.

Google Account

Search Google Account

Home

Personal info

Data & personalization

**Security**

People & sharing

Payments & subscriptions

Help

Send feedback

**R**

Welcome, Respected Surveys

Manage your info, privacy, and security to make Google work better for you

**Review your privacy settings**  
Take the Privacy Checkup, a step-by-step guide that helps you choose your privacy settings  
[Get started](#)

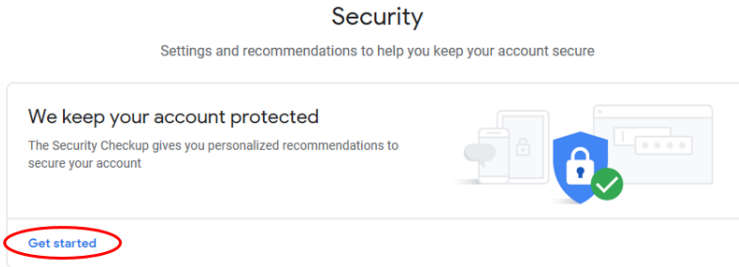
**Security issues found**  
Protect your account now by resolving these issues  
[Secure account](#)

**Make Google yours**  
See the data in your Google Account and choose what activity is saved to personalize your Google experience  
[Manage your data & personalization](#)

**Account storage**  
Your account storage is shared across Google services, like Gmail and Photos  
0% used – 0 GB of 15 GB  
[Manage storage](#)

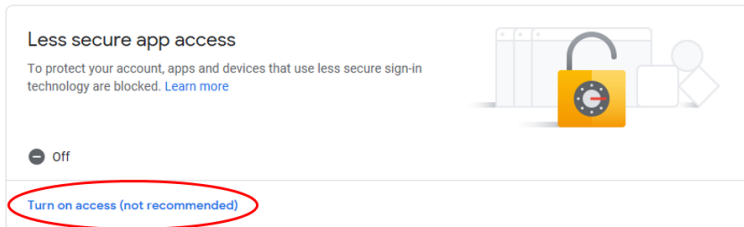
Only you can see your settings. Google is committed to protecting your privacy and security. [Learn more](#)

Fig. 7.6: Gmail account home



*Fig. 7.7: Gmail Security*

Scroll down to **Less secure app access** and click on **Turn on access (not recommended)**.

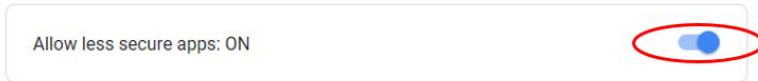


*Fig. 7.8: Gmail Less secure app access*

Finally, click on the slider to turn the less secure access on

## ← Less secure app access

Some apps and devices use less secure sign-in technology, which makes your account more vulnerable. You can **turn off** access for these apps, which we recommend, or **turn on** access if you want to use them despite the risks. [Learn more](#)



*Fig. 7.9: Gmail Less secure app access*

### 7.4.9 Manage email recipients

When you send a survey by email, the recipients are saved automatically to an address book. You can quickly add these recipients again when sending new surveys.

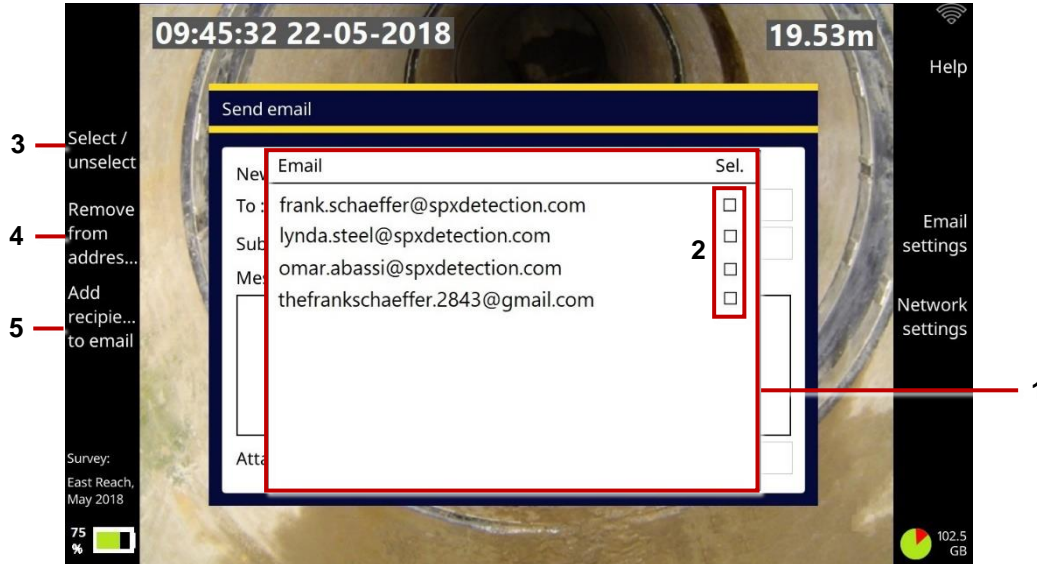


Fig. 7.10: Managing email recipients. 1 Address book. 2 Recipient check boxes. 3 Select/unselect button. 4 Remove from address book button. 5 Add recipients to email button.

To manage recipients in the address book:

- 1 Use the  $\uparrow\downarrow$  arrow keys to highlight a recipient.
- 2 Press Enter to select (or clear) the recipient's check box. Or press the **Select/unselect** button.
- 3 Do one of the following:
  - Press the **Add recipients to email** button to add selected recipients to your email.
  - Press the **Remove from address book** button to delete selected recipients.

### 7.4.10 Export to Dropbox

**Note:** *You can only export single surveys to Dropbox. If you are exporting multiple surveys, the Dropbox export method is not available.*

After choosing Dropbox as the export method, follow these steps:

- 1 (Optional) If required, press the **Network settings** button to connect to a different WiFi network.
- 2 (Optional) If required, press the **Dropbox settings** button to change or update the authentication details for a valid Dropbox account. See [page 121](#).
- 3 (Optional) Specify the export options; see [page 206](#). That is, choose which items to export:
  - a. Press the **Export options** button.
  - b. Use the keyboard to select the items you want to export. Use the  $\uparrow$  $\downarrow$  arrow keys to highlight an item. Then press Enter or the space bar to select its check box.
  - c. Press the **Save** button to save your export selections.

- 4 In the *Export to Dropbox* dialog, specify the **Dropbox destination**. This is the target subfolder that will contain your uploaded survey.

Surveys are always uploaded to a subfolder below the [\Pearpoint Cloud](#) folder. By default, this subfolder is based on the controller ID and survey ID but you can specify a custom subfolder.

See [page 221](#) for a full description of the default Dropbox destination.



*Fig. 7.11: Export to Dropbox dialog*

- 5 Press the **Export** button to start the export.

See the next section for details about where to find your survey files in Dropbox.

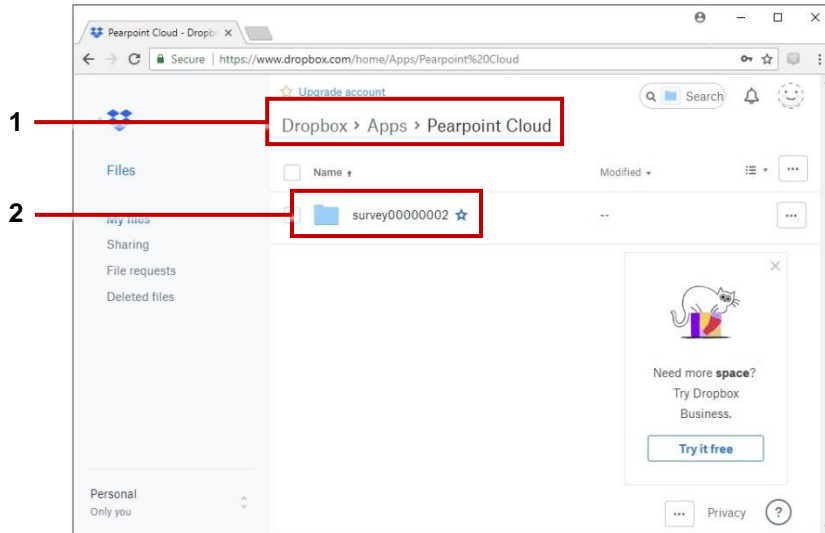


### 7.4.11 Where is my survey in Dropbox?

When you log in to Dropbox, you can find your uploaded survey files in this subfolder:

[Files](#) > [Apps](#) > [Pearpoint Cloud](#) > [\[Controller ID\]](#) > [\[Survey ID\]](#)

Where [\[Controller ID\]](#) is the serial number that uniquely identifies the controller unit used for the survey and [\[survey ID\]](#) is the sequential ID number assigned to your survey by the controller. In the example below, the survey is uploaded to the `\survey0000002` folder.

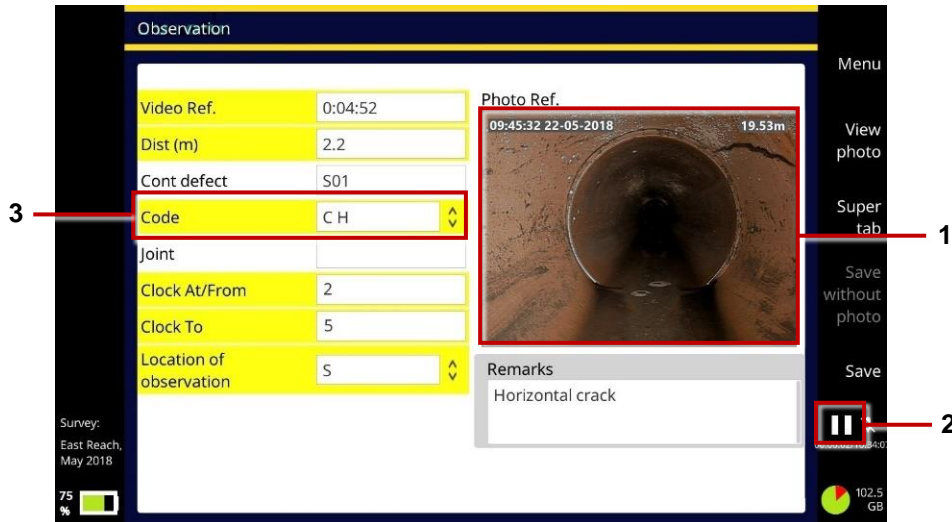


*Fig. 7.12: Dropbox files screen.*

- 1 Path to 'Pearpoint Cloud' folder.*
- 2 Folder containing exported survey.*

## 7.5 Observations

Observations form an essential part of your survey report. Observations are used to give a detailed yet concise description of your findings. For example, you can record pipe defects, connections, and debris.



*Fig. 7.13: Example observation with (1) photo. Video recording pauses automatically (2) while you add the observation details. Select a condition code (3) to identify the defect type.*

An observation typically includes the camera distance, a photo (screenshot), the condition code, plus any additional comments. Observations are usually entered sequentially as you conduct your survey.

You can add observations while recording a new survey video or while playing back an existing video.

Observations and associated photos are listed in survey reports when you export a survey. They are also recorded on sewer and manhole diagrams in your survey reports; see [page 231](#).

### 7.5.1 Condition codes

For MSCC structured surveys, the controller supports WRc's MSCC condition codes for drains & sewers and manhole/inspection chambers. For French and Spanish structured surveys, the controller supports the relevant EN13508 standards. These condition codes describe the physical condition of the pipe or manhole/inspection chamber and the severity of the condition.



These condition codes are available as drop-down menu options in all observation forms for structured surveys, saving you time and ensuring consistency.

To allow fast data entry, you can type the code directly (if you know it). For example, type '**DE**' for debris. Or to list a subset of condition codes, you can type the initial letter. For type '**D**' to see all condition codes beginning with 'D', including codes for debris, deformed sewers, and displaced brocks.


For full descriptions of all condition codes, see the latest *WRc Manual of Sewer Condition Classification*. This manual is available on the Publishing page on the WRc website, [www.wrcplc.co.uk/publishing](http://www.wrcplc.co.uk/publishing).

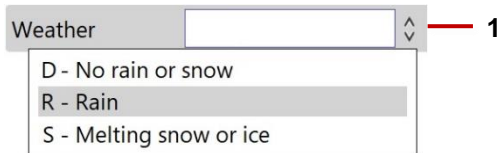
## 7.5.2 Add an observation

Follow these steps:

- 1 Start recording a new video ([page 172](#)) or play back an existing video ([page 189](#)).
- 2 If recording a video, press the  *panel button* ([page 33](#)) or  **New Observation** button ([page 199](#)).  
If replaying a video, press the **New observation** button ([page 189](#)).
- 3 The video recording or playback pauses automatically and the controller saves a photo.  
The photo shows exactly what is on the screen at the time, including any camera rotation, date & time and camera distance. (These on-screen details are configurable; see [page 106](#).)
- 4 In the *New Observation* screen, fill in the fields required by the survey standard.
  - The current field is **highlighted in gray**.
  - Mandatory fields are **highlighted in yellow**. Press the **Super tab** button or Tab key to tab through the mandatory fields only.
  - Press the  $\leftarrow \rightarrow \uparrow \downarrow$  arrow keys to move through *all* the observation fields.

*List continues on next page.*

- The **Code** field has a  button, indicating a drop-down menu (see next page). For drop-down menu shortcuts, see [page 234](#).
- Some observation types (for example, broken pipe, cracks and defective connections) require a *clock reference*; see [page 230](#).



*Fig. 7.14: Field with example drop-down menu. 1 Drop-down menu indicator.*

- 5 Press the **Save** button to save the observation details.  
Alternatively, press the **Save without photo** button. For example, you may choose this save option if vision has been lost because the camera has gone underwater.

### 7.5.3 Jump to observations when playing back a video

You can quickly review video segments that correspond to observations when you play back a video. Follow these steps:

- 1 Play the video; see [page 189](#).
- 2 Press the **Next observation** button to jump to each observation in turn.

**Note:** *You can also use the **Next observation** button while the video is paused.*

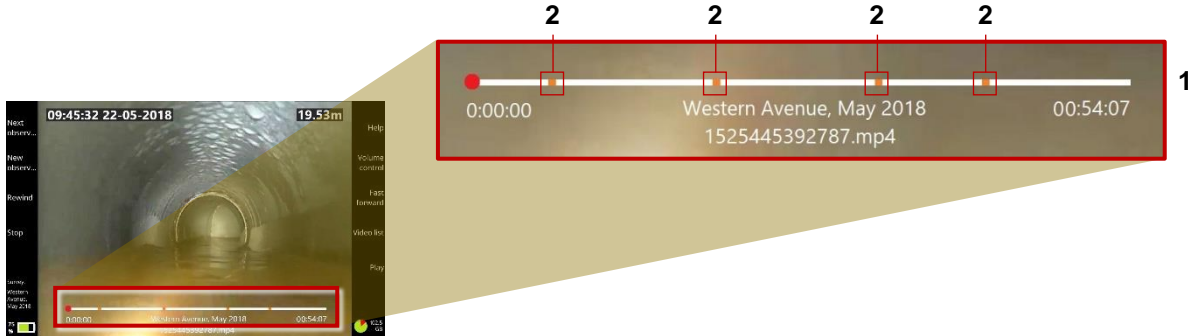




Fig. 7.15: Video progress bar (1) showing position of observations (2)

### 7.5.4 View or edit an observation

Follow these steps:







- 1 In the home screen, press the  **Existing surveys** button.
- 2 Open the survey that you want to manage.  
In the *Edit Survey* screen now displays; see [page 199](#).
- 3 In the *Edit Survey* screen, press the  **List observations** button.
- 4 In the *Observation List* screen, use the ↑↓ arrow keys to select the observation you want.
- 5 Press the Enter key or the **Open** button.
- 6 In the *Observation* screen, edit the fields as required; see [page 224](#) for guidance.

### 7.5.5 Delete observations





**Note:** *If you delete an observation, the associated photo is also deleted and cannot be recovered.*

Follow these steps:

#### ▪ Delete a single observation

- a. In the home screen, press the  **Existing surveys** button
- b. In the *Existing Surveys* screen, open the survey with the observations you want to delete. Use the   arrow keys to select a survey.
- c. In the *Edit Survey* screen, press the  **List observations** button.
- d. In the *Observation List* screen, use the   arrow keys to select an observation
- e. Press the **Delete observation** button. You will be asked to confirm, by pressing the **Confirm delete** button.

#### ▪ Delete multiple observations

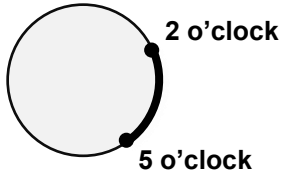
- a. In the home screen, press the  **Existing surveys** button
- b. In the *Existing Surveys* screen, open the survey with the observations you want to delete. Use the   arrow keys to select a survey.
- c. In the *Edit Survey* screen, press the  **List observations** button.



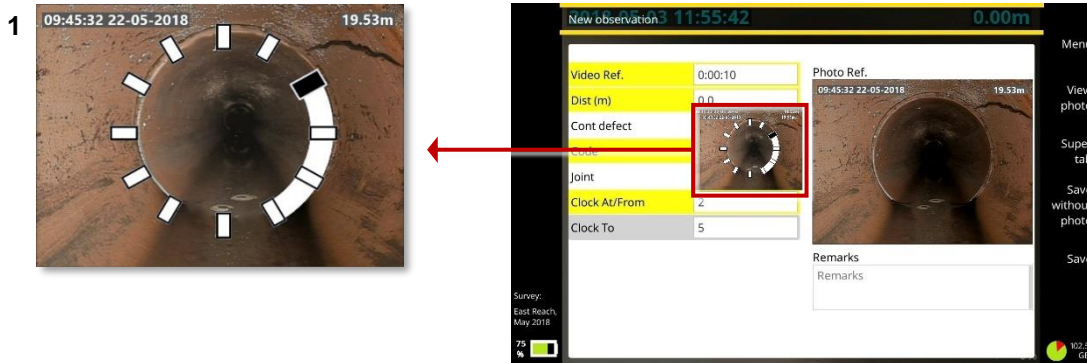
- d. Press the **Select multiple** button.
- e. In the *Observation List* screen, use the  $\uparrow\downarrow$  arrow keys to highlight an observation. Then press Enter or the space bar to select its check box.
- f. Repeat the previous step each observation you want to delete. Or press the **Select all** button.
- g. Press the **Delete selected** button. You will be asked to confirm, by pressing the **Confirm delete** button.

## 7.5.6 Clock references

Many observations require a clock reference to locate the defect's position on the pipe wall. For example, you can observe a circumferential crack extending from 2 o'clock to 5 o'clock:



*To help you record these defects accurately, when you type 1 to 12 in a Clock field, a pop-up observation photo is shown with a superimposed clock face that highlights your clock references.*

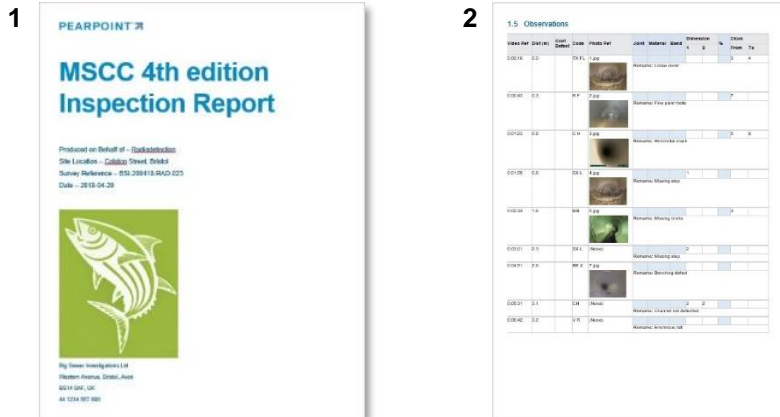


*Fig. 7.16: Entering a clock reference. 1 Clock face on pop-up photo illustrates the clock references. In this example, a circumferential crack is observed from 2 o'clock to 5 o'clock.*

## 7.6 Reports

A survey report is generated when you export a survey ([page 205](#)). Reports are generated in DOCX and XML format. The report includes the survey header details plus any observations.

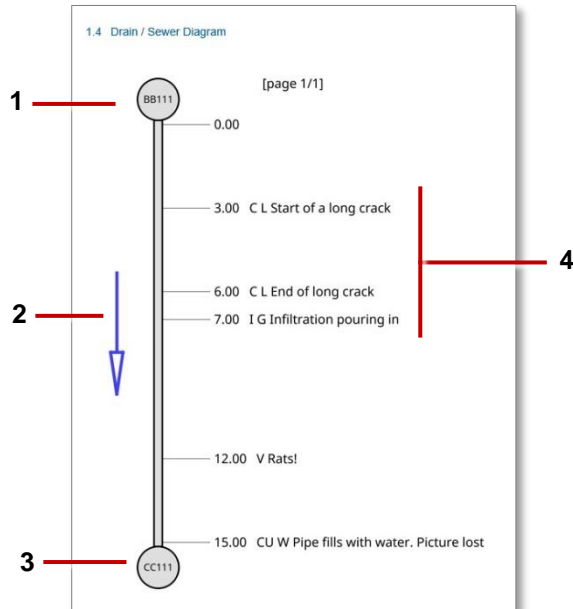
For DOCX reports, a title page shows your company details and (if specified) your company logo. The report also includes observation photos and a drain/sewer diagram or manhole/inspection chamber diagram, showing the relative locations of the individual observations; [see pages 232 and 233](#).



*Fig. 7.17: DOCX survey report. 1 Example title page with company details and logo. 2 Observations page. Observations are presented in tabular form with thumbnail photos.*

## 7.6.1 Drain and sewer diagrams

These diagrams are included in MSCC *Drain/Sewer* survey reports; see [page 234](#) for the full survey list.

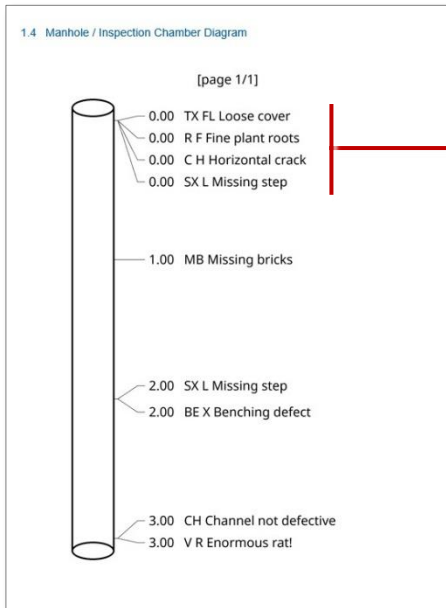


- 1 *Start node reference*
- 2 *Direction. Shows whether the camera was pointing downstream (with the flow) or upstream (against the flow)*
- 3 *Finish node reference*
- 4 *Observations. For each observation, the diagram shows the distance and code, plus any remarks.*

*Fig. 7.18: Example drain/sewer diagram for survey report.*

## 7.6.2 Manhole and inspection chamber diagrams

These diagrams are included in MSCC *Manhole/Inspection Chamber* survey reports; see [page 234](#) for the full survey list.



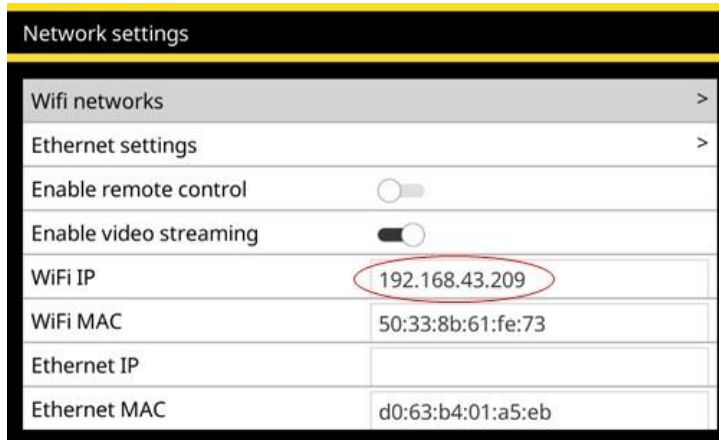
**Observations.** For each observation, the diagram shows the depth (vertical distance) and code, plus any remarks.

Fig. 7.19: Example manhole/inspection chamber diagram for survey report.

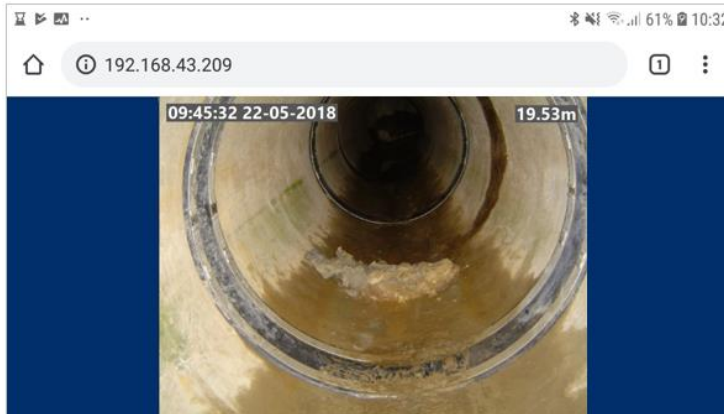
## 7.7 Video streaming

You can stream the video images showing on the display of the flexiprobe C550c to a nearby connected device, such as a cell phone or tablet by following these steps:

1. Connect your device as a hotspot to the flexiprobe C550c
2. Open the Settings menu, then the Networks item
3. Scroll to “Enable video streaming” and activate
4. Note the IP address in the “WiFi IP” box



5. Open Safari (12 or newer), Chrome (71 to 73) or Microsoft Edge (contact CUES for version information) on your device, type the noted IP address into the browser address bar and press Go.





6. The streamed video will show in the browser, as shown above.

If you encounter difficulties, check that your browser is compatible with this feature (see step 5 above). Also move your device closer to the flexiprobe C550c to ensure a good connection between the two units. Some devices are incompatible with the video streaming feature. Contact CUES for additional and updated information.

## 7.8 Menu shortcuts

When you create a new survey or add an observation, fields with  buttons have a drop down menu.

- Press Enter to display the drop-down menu.
- Press the   arrow keys to select the menu item you want. Then press Enter again.
- Type one or more letters to filter the menu by item(s) starting with those letters.

**Example:** In a **Weather** field, type 'r' to automatically select 'R - Rain'.

**Example:** In a **Code** field, type 'fw' to filter the menu to only show flow codes such as 'FW C - Clear flow' and 'FW T - Turbid flow'.

- You can also filter the menu by typing any text that appears in a menu item *description*.

**Example:** In a **Code** field, type 'oxygen' to filter the menu to only show codes with a matching description such as 'OD – Hazardous atmosphere, oxygen deficiency'.

**Note:** You cannot type ( or ) characters to filter a drop-down menu.

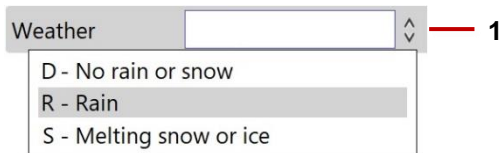


Fig. 7.20: Field with example drop-down menu. 1 Drop-down menu indicator.



## 7.9 Supported survey standards

The C550c controller currently supports the following survey standards. Survey header details for these standards contain condition codes relevant to each standard.

- MSCC3
- MSCC4 Domestic (Drain/Sewer)
- MSCC4 Sewerage (Drain/Sewer)
- MSCC4 Sewerage (Manhole/Inspection Chamber)
- MSCC4 Highways (Drain/Sewer)
- MSCC5 Domestic (Drain/Sewer)
- MSCC5 Sewerage (Drain/Sewer)
- MSCC5 Sewerage (Manhole/Inspection Chamber)
- MSCC5 Highways (Drain/Sewer)
- MSCC5 Domestic (Manhole/Inspection Chamber)
- EN13508-FR
- EN13508-ES

**Note:** *MSCCx refers to the Manual of Sewer Condition Classification 3rd, 4th or 5th Edition.*

## 7.9.1 WinCan-compliant surveys – option

The C550c can support users who wish to generate reports compliant with WinCan reporting PC software. In the *Create survey* menu, select *WinCan survey* from the *Format* drop-down menu

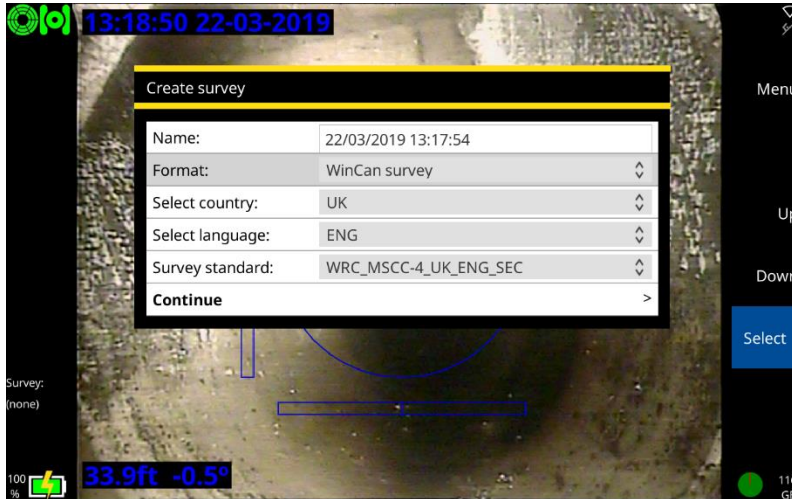


Fig. 7.21: Create survey menu showing WinCan survey as the format type.

Please see [page 127](#) for guidance on enabling your P550 to create WinCan-compliant surveys.

## Performing surveys

Surveys are performed in the same way as other surveys.

### **WinCan survey reports**

Users can export to USB or, using a WiFi hotspot, via email or to DropBox. Exports to DropBox and via email contain an xml format file that can be imported into a WinCan-enabled PC. Exports to USB will also contain a copy of the mp4 video file. Users can use a WinCan-enabled PC.

## 8 WinCan PC connections

Users can connect a WinCan-enabled PC their flexitrax C550c controller to control their C550c system. Firstly, connect the HDMI output of the C550c to the video input of the PC (using a relevant adapter if necessary). Then follow the steps here for making the Ethernet connection either via a router (see section 8.2) or without a router (see section 8.1 below).

## 8.1 Ethernet connection – no router

Follow the steps detailed below to enable control of your C550c system directly from your WinCan VX-enabled PC, without a router.

- 1 Connect an Ethernet cable between the Ethernet port on the flexitrax C550c controller and an Ethernet socket on the PC, either directly, if the PC itself has an Ethernet port, or using an adapter such as a “USB to Ethernet” converter.

**Note:** *For most set-ups, any good quality Ethernet cable is suitable, but using a crossover Ethernet cable can help solve some connection issues, particularly for older equipment.*

- 2 From the C550c controller Start-up screen, select

Settings > Network > Ethernet settings

- 3 Set the **IP assignment** to **Manual**.


- 4 Set the **IP address** to 192.168.137.1

**Note:** *You can choose an arbitrary IP address, but it must be of this format. If you select a different IP address, ensure the next steps follow a similar layout.*

- 5 Set the **Subnet mask** to 255.255.255.0

- 6 Set the **Default gateway** to 192.168.137.2

- 7 Set the **DNS server** to 192.168.137.2
- 8 Select **Save & Exit** to return to **Network settings**
- 9 Confirm that the **Ethernet IP** matches your selected IP address
- 10 Confirm that the C550c controller's Ethernet icon in the top right hand corner of the display shows that the connection is enabled as shown in [Figure 8.1](#).

A line through the icon, , means that you do not have connection. Please repeat the steps above to ensure all values have been entered correctly.

- 11 Select **Enable remote control**.

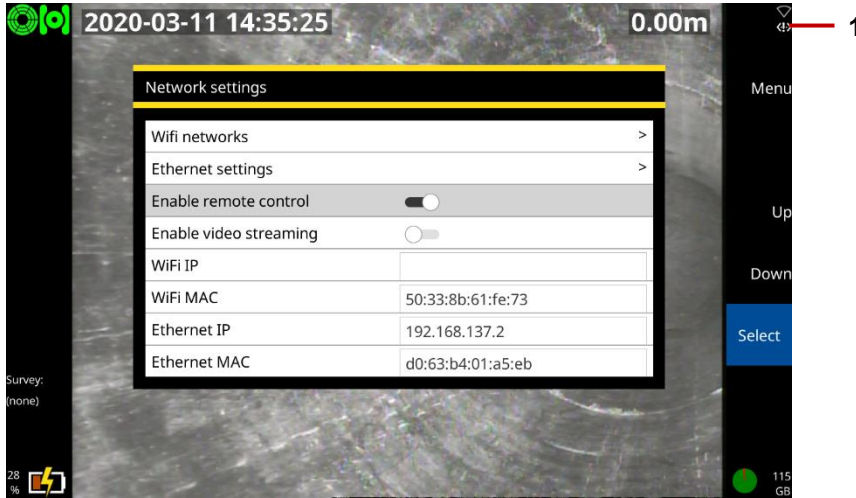
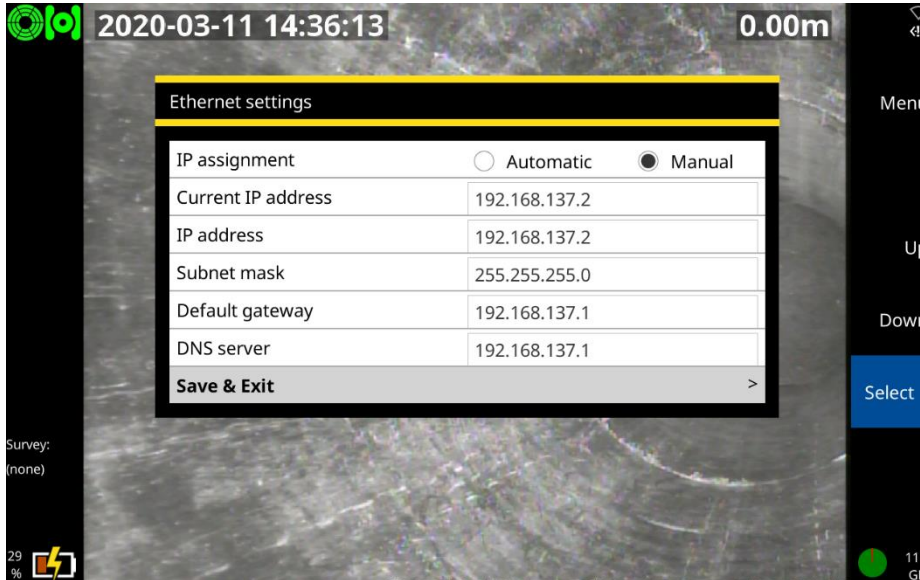


Fig. 8.1: Network settings screen showing **Remote control enabled**. **1** the Ethernet icon signifying a good connection



*Fig. 8.2: Ethernet settings screen with values that allow control of the C550c system by a WinCan VX-enabled PC.*

- 12 Press **Back** or **Esc** to return to the Start-up screen
- 13 On the PC enter the **Network and Sharing Centre** via the **Control Panel**.
- 14 Select **Change adapter settings**.



- 15 Right click the **DVC2 Ethernet** connection and select **Properties**.
- 16 Double click **Internet Protocol Version 4**.
- 17 Select **Use the following IP address**.
- 18 Enter the IP address **192.168.137.2**.
- 19 Set the **Subnet mask** to **255.255.255.0**.
- 20 Click on **OK** to leave **Internet Protocol Version 4**.
- 21 Select **OK** again to leave **Ethernet DVC2 Properties**.
- 22 Open **WinCan VX**.
- 23 In the WinCan screen go to  
  
Home > Settings > OSD > Select device
- 24 Select **Pearpoint - P350**.
- 25 Select **Configure the device**.
- 26 Enter the IP address from the C550c controller (eg **192.168.137.1**) into the IP address field

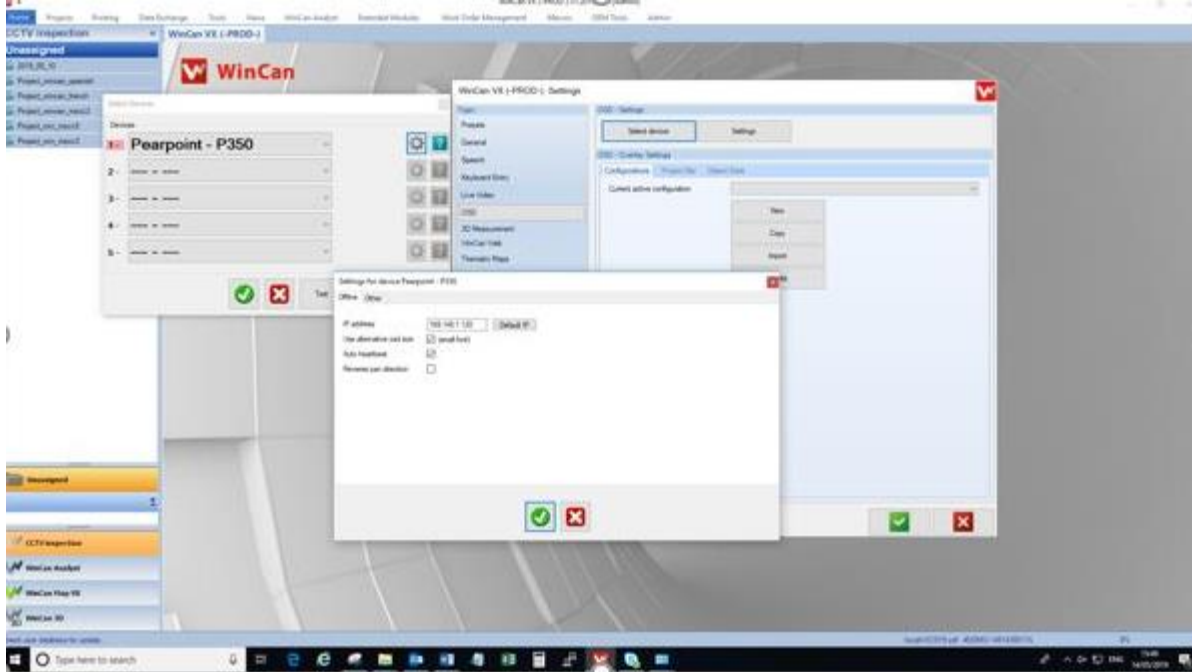


Fig. 8.3: WinCan VX screen showing the IP address box.

27 Select **OK** (✓) to return to the **Select Devices** page.

- 28 Select **OK** (✓) to return to the **WinCan VX Settings** page.
- 29 Select **OK** (✓) to return to the main **WinCan VX** page.
- 30 Select **Projects** and open a new or an existing project.
- 31 Select **Set distance** and enter a new distance and select **OK** (✓)
- 32 Confirm the new distance is displayed on the controller.

You will now be able to control the crawler, the camera and the rest of the C550c system from the PC.

## 8.2 Ethernet connection – via router


Follow the steps detailed below to enable control of your C550c system if your WinCan-enabled PC is connected to your flexitrac C550c controller via a router.

- 1 Connect the flexitrac C550c controller to the router, and the router to the PC, with Ethernet cables. Power up the router.

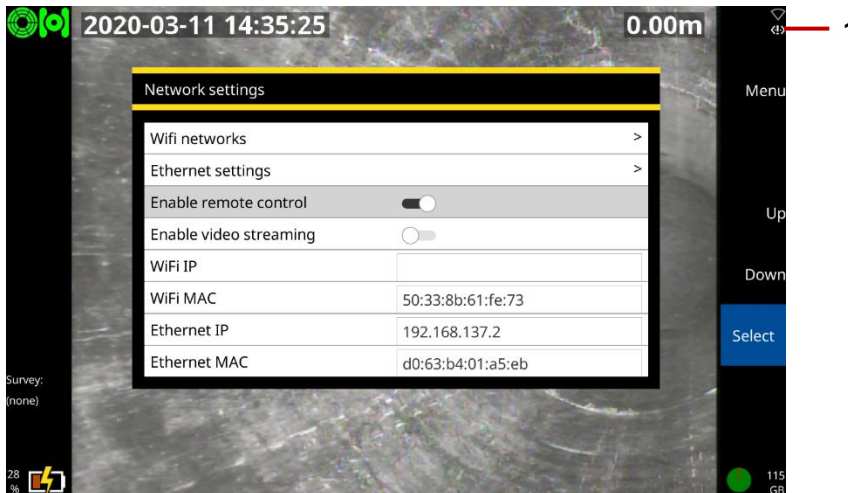
**Note:** *For most set-ups, any good quality Ethernet cables are suitable, but using a crossover Ethernet cable between the C550c controller and the router can help solve some connection issues, particularly for older equipment.*

- 2 From the C550c controller Start-up screen, select  
Settings > Network > Ethernet settings
- 3 Set the **IP assignment** to **Automatic**.
- 4 Select **Save & Exit** to return to **Network settings**
- 5 Confirm that the **Ethernet IP** matches the new IP address on the C550c controller's Ethernet settings page

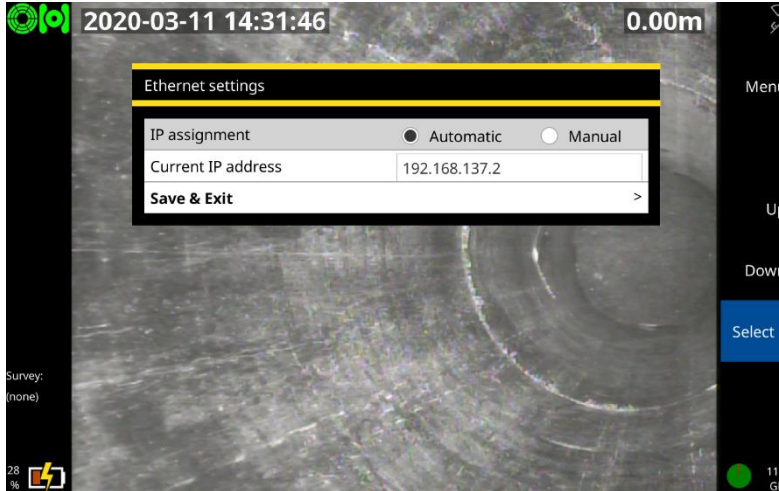
- 6 Confirm that the C550c controller's Ethernet icon in the top right hand corner of the display shows that the connection is enabled as shown in [Figure 8.1](#).

A line through the icon, , means that you do not have a connection. Please repeat the steps above to ensure all values have been entered correctly.

- 7 Select **Enable remote control**.



*Fig. 8.4: Network settings screen showing **Remote control enabled**. 1 the Ethernet icon signifying a good connection*



*Fig. 8.5: Ethernet settings screen with values that allow control of the C550c system by a WinCan VX-enabled PC.*

- 8 Press **Back** or **Esc** to return to the Start-up screen
- 9 On the PC enter the **Network and Sharing Centre** via the **Control Panel**.
- 10 Select **Change adapter settings**.
- 11 Select **Change adapter settings**.

- 12 Right click the **DVC2 Ethernet** connection and select **Status**.
- 13 Select **Details...**
- 14 In **Network Connection Details** note the IPv4 Address and the **Subnet mask**.
- 15 Select **Close** to return to the **Ethernet DVC2 Status** and then **Close** again to return to the **Network Connection** page.
- 16 Right click the DVC2 Ethernet connection and select **Properties**.
- 17 Double click **Internet Protocol Version 4**.
- 18 Select **Use the following IP address**.
- 19 Enter the noted **IP address** and **Subnet mask** in the required fields
- 20 Check that the IPv4 address matches the C550c controller Ethernet IP address except that the last digit is 1 or 2 higher or lower
- 21 Check that the **Subnet mask** is identical to that of the C550c controller
- 22 Click on **OK** to leave **Internet Protocol Version 4**.
- 23 Select **OK** again to leave **Ethernet DVC2 Properties**.
- 24 Open WinCan VX
- 25 From the WinCan screen go to

Home > Settings > OSD > Select device

26 Select **Pearpoint - P350** from the first device drop down menu.

27 Select **Configure the device**.

28 Enter the controller IP address from the C550c controller in the IP address field.



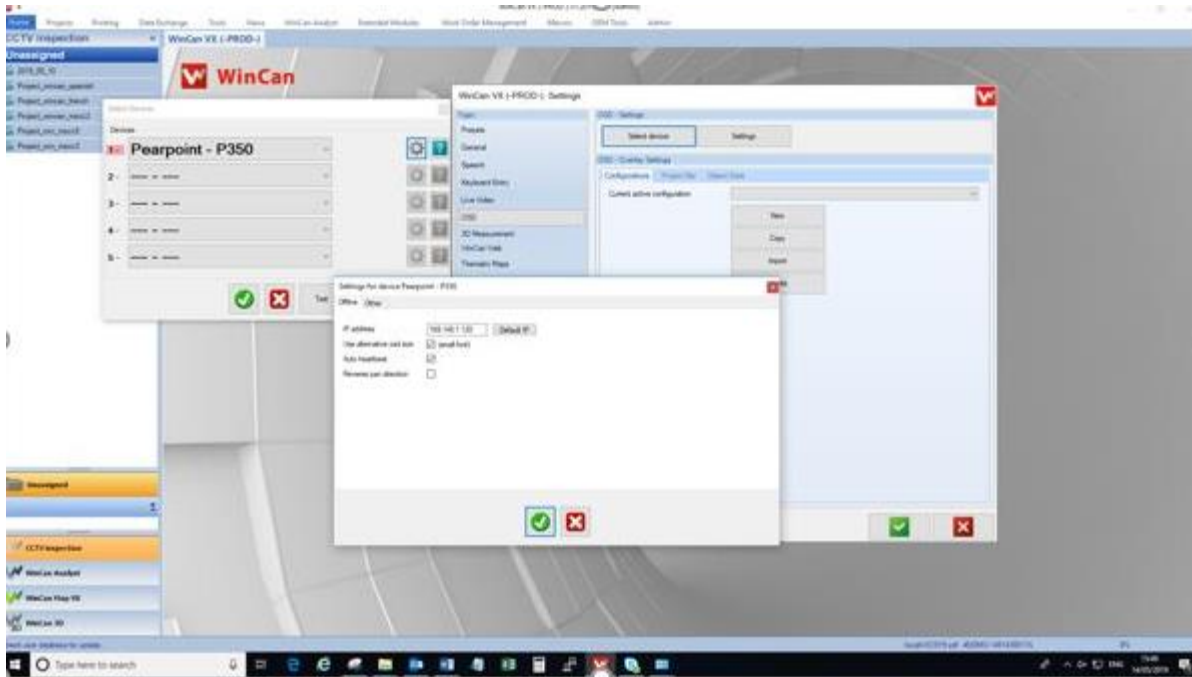


Fig. 8.6: WinCan VX screen showing the IP address box.










29 Select **OK** (✓) to return to **Select Devices** page.

- 30 Select **OK** (✓) to return to **WinCan VX Settings** page.
- 31 Select **OK** (✓) to return to the main **WinCan VX** page
- 32 Select **Projects** and open a new or an existing project.
- 33 Select **Set distance** and enter a new distance and select **OK** (✓).
- 34 Confirm the new distance is displayed on the controller.

You will now be able to control the crawler, the camera and the rest of the C550c system from the PC.

## 9 Status icons

The home screen displays status icons in the top left hand corner, referring to the drum and either the crawler or pushrod that is connected. In normal operation the drum and crawler icons are green and the pushrod is white. The different icons displayed, and what they represent, are:

Drum icons	Crawler icons	Pushrod icons
 Normal operation	 Normal operation	 Normal operation
 Drum software being updated	 Crawler software being updated	
 Pre-stall condition	 Pre-stall condition	
 No drum software detected	 No crawler software detected	
Drum not detected	Crawler not detected	Pushrod not detected

## 10 Maintenance and cleaning

### 10.1 Maintenance



**Warning!** *Do not dismantle any component parts. This could invalidate your warranty and exposed metal or electrical devices may be hazardous and/or electrically live. We do not permit user-servicing of our systems.*

We recommend that you only assemble or disassemble system components (for example, attaching the camera to the rod) in a dry and clean environment.

We recommend that only authorized service centers carry out service of this product. If this product is serviced elsewhere, this will invalidate your warranty.

#### 10.1.1 Storing the system

The C550c is a precision system. Always store the system, including all components and accessories, in a clean and dry environment.

### 10.1.2 Connection points, terminals and O-rings

**Caution:** *Do not use damaged, dirty or corroded components, including all terminal connections, cables and O-rings.*

Ensure that all terminals and connection points are clean and free of corrosion and debris before you attempt to use this equipment. This particularly affects the link cable connections between the controller and drum, and the connections between cable and crawler, between crawler and lighthouse (if used) and between lighthouse and camera.

Check that any O-rings are clean, greased and not damaged. This particularly applies to the camera O-rings. For example, use a silicon-based grease such as "Super Lube" on the O-rings only.

Do *not* apply grease or lubricant to any pogo pins or the spring PCB. This particularly applies to the connection behind the camera.

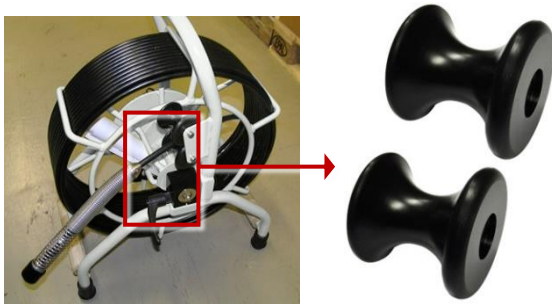
We recommend protecting all terminals with the supplied protective caps when the system is not in use.

### 10.1.3 Rod guide assembly (pushrods only)

Always make sure the rod guide is clean.

Check the rod guide assembly regularly to see if a replacement is needed. Spare rod guides can be purchased and fitted by competent mechanical technicians using a screwdriver. Spare rods and various components are available to purchase as repair kits.

**Caution:** *If the rod wears through the rod guide, it will start to wear through the metal structure of the coiler. Wear to the metal components can cause hazards for the operator (sharp edges or electrical malfunction).*



*Fig. 10.1: Rod guides.*

For servicing information, contact CUES Technical; see [page 23](#). Or contact your CUES representative.

## 10.2 Cleaning the system



**Warning!** *Foul water systems can be a source of biological hazards. Use appropriate gloves when cleaning the system. Always disinfect the camera and pushrod after use.*

**Caution:** *Do not use high-pressure hoses to clean this system.*


To help prevent the risk of biological contamination, clean and sanitize the C550c with a suitable disinfectant at regular intervals and after conducting an inspection. When cleaning the system, consider your working environment.

- **Camera:** Clean water and disinfectant. Clean the lens with a lint-free cloth.
- **Pushrod:** Always clean and disinfect the rod after use. Use a cloth moistened with disinfectant.
- **Controller:** Clean the case with mild soapy water. Use a lint-free cloth to clean the LCD screen.
- **If you need to ship the system:** Clean and sterilize the system before shipping. Always follow any applicable laws and guidelines.

## 10.3 Factory reset

This section describes how to perform a factory reset. This will restore the controller to its original state, erasing any configuration settings currently defined on the device. You must only perform a factory reset if instructed to do so by CUES technical staff.

Follow these steps:

- 1 In the Home screen, press the  **Settings** button (item 6 on [page 34](#)).
- 2 Choose Settings > Maintenance > Factory Reset.
- 3 When the controller restarts, a setup wizard launches automatically. The wizard comprises several menus where you can set preferences and basic details.

Briefly, you will need to re-specify the language, the system date & time, the keyboard layout and your preferred distance units (feet or meters). The wizard also prompts you for your company details; the controller will use these details to personalize the title page of your survey reports.

For full details about the setup wizard, see [page 95](#).



# 11 Software updates

CUES may issue C550c software updates to enhance system performance. We strongly recommend that you periodically check for new software releases and update your controller when new software is made available. Controller software updates are free of charge.

Updating the software is straightforward. Follow these steps:

- 1 When the controller connects to the internet (see [page 207](#)), it automatically compares your current software with the latest version available on the Pearpoint web site. If a newer version is available, it displays a Software Update advisory. Go to step 2.

Alternatively, you can manually check whether a software update is available.

- a. Check your controller's current software version. On the controller, select Settings > Maintenance > Software versions.
  - b. Check the latest version available on the Pearpoint web site. Go to step 2.
- 2 Now download the software update. Follow these steps:
    - a. Browse to [www.pearpoint.com](http://www.pearpoint.com) and go to the P550c product page, the same file is used for the C550c and the P550c.
    - b. Scroll down to the Software section.

c. If a newer software version is available, download the newer version. The download file is:

[dvc2-<n.n.n.n>.rdu](#)

Where [<n.n.n.n>](#) is the controller software version.

- 3 Copy the downloaded file to the root of a USB memory stick.
- 4 Connect the controller to the mains power supply and insert your USB memory stick into your controller.

**Caution:** *Always connect the controller to the mains supply before updating the software. This ensures a reliable power source.*

- 5 On your controller, select Settings > Maintenance > Software Update and follow the on-screen instructions.

- 6 Wait while the controller updates the software. This process may take several minutes

**Caution:** *Do not switch off the controller or remove the USB memory stick while the upgrade is in progress. Interrupting the upgrade may leave the controller inoperable.*

- 7 When the update is complete, the controller prompts you to restart.

When the controller restarts, the update process is complete.

# 12 Specifications

## 12.1 Controller specifications

flexitrax C550c Controller	
Battery capacity	Internal Li-Ion Battery (4S2P) - 14.68V, 6.4Ah (93.95Wh)
Battery run-time	Up to one day's typical usage, 7.5hrs view only / 5hrs continuous recording*
Connectivity	USB 2.0 (x3), HDMI video out, Analog video In (PAL/NTSC), Headphones out, Microphone in, Rod/Camera/Drum connectivity and 802.11 b/g/n WiFi
Construction	High impact ABS and powder-coated, zinc-plated mild steel
Controllers	flexitrax C550c command module with integrated controls for the crawler, camera, lights and sonde, and powered drum and powered elevator where fitted
	Optional pendant controller for deployment phase
Dimensions	17.5 x 15.2 x 6.1" / 445 x 385 x 155mm
Display	12.1" / 307mm, 1280 x 800 color LCD
Environmental Protection	flexitrax C550c controller: IP55
	Power supply / charger: IP54 rated for indoor use
Input power requirements	10-30V, 60W
Power sources	Power from drum, external mains PSU or internal battery

flexitrax C550c Controller (continued)	
Power supply	Mains Input 100-240VAC, 50-60Hz, 1.7A
	DC Output 16V, 3.75A, 60W
Recording formats	Video: H.264. Audio: MP3. File format: MP4
Report File Formats	Basic reports, MSCC3 & 4: docx
	MSCC5: docx or Xml
	WinCan: Xml
	Video: MP4
	Image: JPEG
Storage	Integral 128Gb and support of USB flash storage
Temperature	Storage: 4°F to 176°F / -20°C to +80°C
	Operating: 14°F to 122°F / -10°C to +50°C
	Charging: 32°F to 104°F / 0°C to +40°C
Weight	16lb / 7.25 kg

## 12.2 Drums and PSU

Drums and PSU	Powered drum	Manual drum system	
		Manual drum	Power supply
Cable lengths available	100m, 150m, 200m, 250m, 305m / 330', 495', 660', 820', 1000'	-	
Connectivity	Direct pushrod connection, power,	Power supply	Direct pushrod connection, power, controller and pendant
Power supply	110-240V 50-60Hz 1.2kVA Inverter or generator to have sine-wave output	C550 Power supply	110-240V 50-60Hz 1.2kVA Inverter or generator to have sine-wave output
Construction	Powder coated steel chassis / frame with steel and Aluminum enclosure Stainless steel and Aluminum cable management mechanism		Powder coated steel chassis / frame with steel and Aluminum enclosure
Dimensions	619 x 405 x 691mm 24.4 x 16 x 27"	445 x 270 x 570mm 17.5 x 10.6 x 22.4"	418 x 195 x 420mm 16.5 x 7.7 x 16.5"
Ingress protection	IP55		
Weight (dependent on cable length)	60 to 75kg / 130 to 154lbs	20 to 35kg / 44 to 77lbs	17kg / 37.5lbs

## 12.3 Crawlers

Crawlers	P354 small crawler	P356 medium crawler
Centered pipe inspection diameter range (with appropriate)	125 – 381mm / 5 – 15"	175 – 900mm / 7 – 36"
Construction	Brass and Stainless Steel	
Ingress protection	IP68	
Ingress sealing	Rated to a depth of 100m / 330' of water	
Sonde frequency	Selectable 512Hz / 640Hz / 8kHz / 33kHz	
Sonde detection depth	Up to 3m / 10'	
Inclinometer accuracy	±0.2°	
Steering	Fixed	Steerable
Motor(s)	1 x 50W GP32C Maxon motor	2 x 50W GP32C Maxon motor
Weight	5.4kg / 12lbs	14.3kg / 31.5lbs
Dimensions (without wheels attached)	250 x 82 x 69mm / 9.8 x 3.2 x 2.7"	345 x 128 x 84mm / 13.6 x 5 x 3.3"

## 12.4 Elevators

Elevators	Fixed elevator	Large manual elevator	Powered elevator	Powered elevator and Compact Cradle	Powered elevator and Cradle
Centered pipe inspection diameter – P354 crawler	305mm / 12"	–	–	–	–
Centered pipe inspection diameter – P356 crawler	380mm / 15"	305 – 610mm / 12 – 24"	305 – 900mm / 12 – 36"	775 - 1360mm / 30 - 54"	900 - 1500mm / 36" - 60"
Construction	Stainless steel / Anodized Aluminum	Stainless steel / Anodized Aluminum	Stainless steel / Anodized Aluminum	Stainless steel / Anodized Aluminum	Stainless steel / Anodized Aluminum
Weight (not including crawler or camera)	0.4kg / 0.9lbs	4.5kg / 9.9lbs	5.8kg / 12.8lbs	20.8kg / 46lb	27.8kg / 61lb
Dimensions @ maximum elevation	114 x 48 x 67mm / 2.5 x 1.9 x 2.9"	230 x 90 x 420mm / 9 x 3.6 x 16.5"	380 x 110 x 420mm / 15 x 4.3 x 16.5"	690 x 419 x 617mm / 27.2 x 16.5 x 24.3"	739 x 534 x 712mm / 29.1 x 21 x 28"

## 12.5 Lighthouse

Lighthouse	Provides additional light for large or dark pipes
Lighting	8 White LEDs, ≥ 850 Lumen
Construction	Stainless Steel and Aluminum
Ingress protection	IP68
Ingress sealing	Rated to a depth of 100m / 330' of water
Weight	1.8kg/4.0lbs
Dimensions	Ø 136 x 63mm / Ø 5.4 x 2.5"

## 12.6 Crawler cameras

Cameras	Forward-view	Pan-Tilt	Pan-Tilt-Zoom
Functions	Forward view only	Pan 270°/Rotate 360°	Pan 270°/Rotate 360°
Zoom	3x digital	3x digital	10x optical
Resolution	≥ 540TVL	≥ 540TVL	≥ 530TVL
Sensitivity	<1.0Lux	<1.0Lux	1.0Lux @ f1.8
On-camera lighting	≥ 120lm	≥ 210lm	≥ 420lm
Focal Range	10 mm to ∞		10 mm (WIDE) to ∞
Construction	Stainless Steel	Stainless Steel and Anodized Aluminum	Stainless Steel and Anodized Aluminum
Dimensions	Ø 62 x 68mm / Ø 2.4 x 2.7"	Ø 134 x 68mm / Ø 5.3 x 2.7"	Ø 175 x 100mm / Ø 6.9 x 4"
Weight	600g / 1.3lbs	1.8kg / 4.0lbs	2.9kg / 6.4lbs*



## 12.7 Crawler wheels and spacers

Crawler wheels	Types available	
Solid wheels	Choice of: Soft compound (high grip) or Hard compound (more durable) tires	
	Small: Ø 62mm / 2 <sup>1</sup> / <sub>2</sub> " P354: for 100mm / 4" pipes P356: for 150mm / 6" pipes	Medium: Ø 110mm/4 <sup>1</sup> / <sub>4</sub> " P354: for 150mm / 6" pipes P356: for 200mm / 8" pipes
Pneumatic wheels	177mm / 7" treaded tires for use in larger pipes P356: for pipes larger than 375mm / 15"	
Dual pneumatic wheels	Stack pneumatic tires 2-wide for additional grip or to raise camera position	
Rasp wheels	Abrasive style wheels provide additional traction in slippery or relined pipes	
	Small	Medium

Wheel spacers	To space wheels out, providing centering in specific pipe sizes	
For Rasp wheels	Small, with spacers: P354: for 150mm / 6" pipes	Medium, with spacers: P354: for 200mm / 8" pipes P354: for 230mm / 9" pipes P356: for 200mm / 8" pipes P356: for 230mm / 9" pipes
For medium wheels	P356: for 230mm / 9" pipes	

## 12.8 Controller to drum/PSU link cables

Link cables	To connect C550c system modules together, lengths available:				
Controller to PSU/Powered drum	1m / 3'	5m / 16'			
PSU to manual drum	1m / 3'	3m / 10'	10m / 32'	25m / 82'	50m / 164
Controller to flexiprobe® C540c pushrod	5m/16'				

## 12.9 Crawler-wheel-elevator configurations

**Note:** *Larger and double stack wheels should be used where possible for maximum stability.*

Standard wheels	P354 options		P356 options	
	Wheels	Elevator	Wheels	Elevator
100mm/4"	Small standard	None	n/a	n/a
152mm/6"	Medium standard	None	Small standard	None
203mm/8"	Double-stacked medium standard	None	Medium standard	None
254mm/10"	Medium standard	Fixed	Double-stacked medium standard	None
	Medium standard	Adjustable		
305mm/12"	Double-stacked medium standard	Fixed	Medium standard	Fixed
	Double-stacked medium standard	Adjustable	Medium standard	Adjustable
			Medium standard	Large adjustable
381mm/15"	Double-stacked medium wheels	Adjustable	Medium standard	Large adjustable
			Large standard	Fixed
			Large standard	Adjustable

## Crawler-wheel-elevator configurations (continued)

**Note:** Larger and double stack wheels should be used where possible for maximum stability.

Standard wheels	P354 options		P356 options	
Pipe size	Wheels	Elevator	Wheels	Elevator
457mm/18"	n/a	n/a	Large standard	Adjustable
			Large standard	Large adjustable
			Double-stacked large standard	Adjustable
			Double-stacked large standard	Large adjustable
533mm/21"	n/a	n/a	Large standard	Large adjustable
			Double-stacked large standard	Large adjustable
610mm/24"	n/a	n/a	Large standard	Large adjustable
			Double-stacked large standard	Large adjustable
305-762mm/12-30"	n/a	n/a	Medium standard	Powered
381-864mm/15-34"	n/a	n/a	Large standard	Powered
457-915mm/18-36"	n/a	n/a	Double-stacked large standard	Powered

Grit wheels	P354 options – no elevator required		P356 options – no elevator required	
Pipe size	Wheels	Wheel adaptor	Wheels	Wheel adaptor
152mm/6"	Small grit	3-groove	n/a	n/a
203mm/8"	Large grit	4-groove	Large grit	1-groove
229mm/9"	Large grit	5-groove	Large grit	2-groove

## 12.10 Crawler configuration examples

See [page 53](#) for examples of how to configure your crawlers for different pipe diameters.

## 12.11 Pushrod reel and rod specifications

	541 Plumbers	541	542	543
<b>Dimensions</b> (H x W x D)	22.4 x 16.9 x 10.6" 570 x 430 x 269 mm	22.4 x 16.9 x 10.6" 570 x 430 x 269 mm	33.5 x 29.5 x 16.5" 850 x 750 x 420 mm	32.0 x 46.0 x 18.7" 813 x 1168 x 475 mm
<b>Weight</b>	21 lbs (9 kg) 27 lbs (12 kg)	24 lbs (11 kg)	40 lbs (18 kg) 55 lbs (25 kg)	82 lbs (37 kg)
<b>Construction</b>	Powder-coated tubular steel frame			
<b>Rod length</b>	100' (30m)	115' (35m)	200' (60m)	500' (150m )
	200' (60m)		400' (120m)	
<b>Rod diameter</b>	7.5 mm MK1	12.0mm	11.3mm	11.5mm
	9.5 mm MK2			

## 12.12 Pushrod camera specifications

	1" / 25mm	1¼" / 32mm	2" / 50mm
<b>Dimension</b>	1.0 x 1.5" (25 x 39 mm)	1.23 x 2.6" (31 x 66 mm)	1.9 x 2.9" (48 x 73 mm)
<b>Weight</b>	0.1 lbs (60 g)	0.4 lbs (180 g)	0.8 lbs (360 g)
<b>Construction</b>	Stainless steel / polycarbonate	Stainless steel / sapphire glass / polycarbonate	
<b>Power</b>	1.8W	1.3W	3.8W
<b>Environmental</b>	IP68 to 330' (100m) / 11bar	IP68 to 230' (70m) / 7bar	IP68 to 330' (100m) / 11bar
<b>Focus</b>	Adjustable	Fixed	Adjustable
<b>Focal Range</b>	10mm to ∞	Fixed	10mm to ∞
<b>Lighting</b>	Ultra-bright white LEDs	Ultra-bright white LEDs	Ultra-bright white LEDs
<b>LED luminance</b>	≥ 75 lm	≥ 150 lm	≥ 208 lm
<b>Active Pixels (H x V)</b>	656 x 492 NTSC 768 x 576 PAL	640 x 480 NTSC 640 x 576 PAL	768 x 492 NTSC 765 x 582 PAL
<b>Horizontal resolution</b>	≥ 460TVL	≥ 420TVL	≥ 460TVL

## 13 Open Source Software

The software included in this product contains copyrighted software that is licensed under the GNU General Public License (GPL), GNU Lesser Public License (LGPL), and other open source licenses.

Further information including a copy of each license is located in the product on-screen menu under:

Maintenance > Open source software

You may obtain the complete Corresponding Source code from us for a period of three years after our last shipment of this product by sending an email to: [rd\\_support@spx.com](mailto:rd_support@spx.com)

If you require the complete Corresponding Source code to be supplied on a physical medium such as DVD the cost of physically performing the distribution may be charged.

You may also find a copy of the source at [www.pearpoint.com/en/software-downloads](http://www.pearpoint.com/en/software-downloads)

This offer is valid to anyone in receipt of this information.



# 14 Index

address book .....	216	brushes.....	47
audio commentary		attaching.....	83
adding .....	186	calibration .....	165
adjust volume .....	189	reminder on startup .....	166
listening to .....	187	cameras	
auto-connect .....	117	attach to rod .....	78
auxiliary connection panel.....	31	available types.....	45
auxiliary video source.....	105	clean after use!.....	194
battery.....	35, 87	cleaning.....	258
charge before first use.....	89	deploy into pipe .....	168
if low charge .....	90	focusing.....	78
lifespan, how to prolong.....	35	retrieve from pipe .....	194
lifespan, typical.....	36	rotating the video feed .....	182
safety precautions .....	10	safety precautions .....	11
temperature, effect on charging .....	35	specifications.....	274
before you begin .....	2	zero the distance .....	169
biological precautions.....	10	cleaning the system .....	258
brightness .....	104	clock reference .....	229

coiler .....	See <i>reels</i>
company details .....	127
company logo, importing .....	128
compliance .....	4
condition codes .....	222
connection panel	
auxiliary .....	31
main .....	30
connection points .....	256
controller	
cleaning .....	258
front view .....	26
handle-mounted status indicators .....	29
home screen .....	33
overview .....	25
power on .....	94
rear view .....	28
Controller settings .....	104
date and time, setting .....	96
daylight saving time .....	96
debug log .....	125
delete a survey .....	201
diagnostics .....	125
diagrams	
drain and sewer .....	231
manhole and inspection chamber .....	232
disposal of the system .....	12
distance units, setting .....	97
drain and sewer diagrams .....	231
Dropbox	
export to .....	218
file location .....	220
set up connection .....	121
Dropbox Settings .....	121
drop-down menus .....	235
DST .....	See <i>daylight saving time</i>
Edit survey screen .....	198
electrical precautions .....	8, 9, 10
email recipients .....	216
Email settings .....	120
email, exporting to .....	210
Equipment settings .....	110, 111

export a survey .....	204	main connection panel .....	30
export options .....	205	maintenance .....	255
factory reset .....	259	Maintenance settings .....	124
fast forward a video .....	189	manhole and inspection chamber diagrams .....	232
FAT32 .....	125	memory sticks, USB .....	73
flexi .....	46, See <i>universal flexi</i>	menu scrolling wraps around .....	104
flexisondes .....	46, 81	menu shortcuts .....	235
focus tool .....	79	mounting the controller .....	72
focusing the camera .....	78	mouse, not supported .....	74
handle-mounted status indicators .....	29	moving the system .....	12
header details, editing .....	203	network	
headset .....	74	connect to .....	206
home screen .....	33	list of available networks .....	116
idle settings .....	124	Network settings .....	113
internal storage .....	73	NTFS, not supported .....	125
internet connection .....	206	observations .....	221
keyboard .....	73	adding .....	223
language, choosing .....	95	condition codes .....	222
layout choice, for screen overlays .....	107	delete .....	227
lithium-ion battery .....	See <i>battery</i>	editing .....	226
log files .....	125	input form .....	221

jump to .....	225	recording a video	
opacity, text background .....	108	storage capacity of controller.....	73
open a survey .....	200	recording a video .....	177
open source software.....	275	recording a video .....	178
O-rings.....	256	recording a video	
overlay text and shapes		extra videos for current survey .....	180
adding .....	183	reels	
screenshot.....	183	available models.....	43
panel buttons .....	32, 175	features .....	44
password for email sender .....	120	Reel power off/on .....	111
photos		Reel type .....	111
exporting .....	205	reel type, selecting .....	165
in survey reports.....	230	safety precautions .....	11
taking .....	182, 190	specifications.....	273
playing back videos.....	188	rename a survey .....	202
port .....	120	replaying videos.....	188
power management .....	124	reports .....	230
power on the controller.....	94	exporting .....	204
quick start .....	23	rewind a video.....	189
rechargeable battery .....	See <i>battery</i>	rewind the pushrod .....	165
recipients, managing.....	216	risk assessment .....	7

rod		software updates.....	260
cleaning.....	258	software versions.....	125
rewind at startup.....	165	sondes.....	46, 81
rod guide, cleaning.....	257	sort the survey list.....	201
specifications.....	273	specifications.....	262
rotate the video feed.....	182	SSID.....	116
safety notices.....	21	status indicators	
safety precautions.....	8	handle-mounted.....	29
scan.....	118	video recording.....	176
Screen overlay settings.....	106	storage capacity of controller.....	73
search for a survey.....	200	storing the controller.....	255
server, email.....	120	surveys.....	195
Settings menus.....	101	create.....	195
using.....	102	deleting.....	201
setup wizard.....	95	Edit survey screen.....	198
shipping the system.....	258	Existing surveys screen.....	199
shortcuts, for drop-down menus.....	235	exporting.....	204
skids.....	47	header details.....	203
attaching.....	83	managing.....	199
w-skids.....	87	open a survey.....	200
SMTP username.....	120	rename.....	202

search for .....	200	USB memory sticks.....	73
sorting .....	201	FAT32, reformatting to.....	125
WRc MSSC standards.....	236	vehicle	
TCP port .....	120	recharging the battery.....	91
terminals .....	256	video coding formats.....	204
Text background opacity .....	108	video title page.....	<i>See title page</i>
<b>title page</b>		<b>Video title settings</b> .....	108, 109
custom page.....	130	video tools.....	181
designing.....	133	videos	
enable .....	133	exporting .....	204
set up .....	129	maximum size .....	174
<b>settings</b> .....	108, 109	recording .....	174, 177, 178, 180
TLS check box .....	120	recording capacity of controller.....	73
trademarks.....	3	recording indicators .....	176
training.....	22	replaying.....	188
universal brush and skid set.....	83	volume	
updates .....	260	adjusting.....	189
USB		volume control screenshot.....	188
exporting to .....	209	warning symbols .....	6
front controller port .....	27	WiFi	
rear controller ports .....	31	connect to network .....	116, 206

enabling.....	115	WRc MSSC standards .....	236
network list .....	114	w-skids.....	87
status indicators .....	115	zero distance	
switch to different network .....	207	definition.....	21
wizard .....	See <i>setup wizard</i>	zeroing the camera.....	169
wraps around, menu scrolling .....	104		

## Contact us

To see the full range of products and services provided by CUES, visit [www.cuesinc.com](http://www.cuesinc.com).

### **CUES (USA)**

3600 Rio Vista Avenue, Orlando, FL 32805, USA

Toll Free: +1 (800) 327 7791

[salesinfo@cuesinc.com](mailto:salesinfo@cuesinc.com)

### **CUES (Canada)**

1675 Sismet Road, Mississauga, Ontario L4W 1P9,

Canada Toll Free: +1 (877) 297 8957

[larryc@cuesinc.com](mailto:larryc@cuesinc.com)

### **Pearpoint (USA)**

39-740 Garand Lane, Unit B, Palm Desert, CA 92211, USA

Tel: +1 800 688 8094 Tel: +1 760 343 7350

[pearpoint.sales.us@spx.com](mailto:pearpoint.sales.us@spx.com) [www.pearpoint.com](http://www.pearpoint.com)